

simodrive

Induction Motors
1PH7 Main Spindle Drives

SIEMENS

SIEMENS

SIMODRIVE 611

Induction Motors 1PH7 Main Spindle Drives

Planning Guide

Motor Description	1
Technical Data and Characteristics	2
Motor Components	3
Dimension Drawings	4
References	A
Index	

SIMODRIVE® Documentation

Printing history

Brief details of this edition and previous editions are listed below.

The status of each edition is shown by the code in the "Remarks" column.

Status code in the "Remarks" column:

- A** New documentation
- B** Unrevised reprint with new order no.
- C** Revised edition with new status

Edition	Order No. for 1PH7 SIMODRIVE	Remarks
03.04	6SN1197-0AC65-0BP0	A
05.04	6SN1197-0AC65-0BP1	C

This manual is included in the documentation available on CD-ROM (**DOCONCD**)

Edition	Order No.	Remarks
09.04	6FC5 298-7CA00-0BG1	C

Trademarks

SIMATIC®, SIMATIC HMI®, SIMATIC NET®, SIROTEC®, SINUMERIK®, SIMODRIVE® and MOTION-CONNECT® are trademarks of Siemens AG. Other product names used in this documentation may be trademarks which, if used by third parties, could infringe the rights of their owners.

Further information is available on the Internet under:
<http://www.siemens.com/motioncontrol>

This publication was produced with Interleaf V 7

The reproduction, transmission or use of this document or its contents is not permitted without express written authority. Offenders will be liable for damages. All rights, including rights created by patent grant or registration of a utility model or design, are reserved.

© Siemens AG, 2004. All rights reserved

Other functions not described in this documentation might be executable in the control. However, no claim can be made regarding the availability of these functions when the equipment is first supplied or for service cases.

We have checked that the contents of this document correspond to the hardware and software described. Nonetheless, differences might exist and therefore we cannot guarantee that they are completely identical. The information contained in this documentation is, however, reviewed regularly and any necessary changes will be included in the next edition. We welcome suggestions for improvement.

Subject to change without prior notice.

Preface

Information on the documentation

This document is part of the Technical Customer Documentation which has been developed for the SIMODRIVE drive converter system. All of the documents are available individually. The documentation list, which includes all Advertising Brochures, Catalogs, Overview, Short Descriptions, Operating Instructions and Technical Descriptions with order number, ordering address and price can be obtained from your local Siemens office.

For reasons of transparency, this document does not include detailed information about all of the product types. Further, it cannot take into account every conceivable installation, operation or service/maintenance situation.

We would also like to point-out that the contents of this document are neither part of nor modify any prior or existing agreement, commitment or contractual relationship. The sales contract contains the entire obligation of Siemens. The warranty contained in the contract between the parties is the sole warranty of Siemens. Any statements contained herein neither create new warranties nor modify the existing warranty.

Structure of the documentation for 1PH and 1PL motors

The complete Planning Guides for 1PH and 1PL motors can be ordered in paper form.

Table 1-1 Planning Guide with General Section and 1PH and 1PL6 motors

Title	Order number (MLFB)	Language
Induction Motors, 1PH and 1PL6	6SN1197-0AC61-0AP0	German
Induction Motors, 1PH and 1PL6	6SN1197-0AC61-0BP0	English

The General Section and the individual motor series are also separately available.

Table 1-2 Planning Guide, individual sections

Title	Order number (MLFB)	Language
Induction Motors, General Section for SIMODRIVE and SIMOVERT MASTERDRIVES	6SN1197-0AC62-0AP0	German
Induction Motors, Motor Section 1PH2	6SN1197-0AC63-0AP0	German
Induction Motors, Motor Section 1PH4	6SN1197-0AC64-0AP0	German
Induction Motors, 1PH7 Motor Section for SIMODRIVE	6SN1197-0AC65-0AP1	German
Induction Motors, 1PH7 Motor Section for SIMOVERT MASTERDRIVES VC/MC	6SN1197-0AC66-0AP0	German
Induction Motors, 1PL6 Motor Section for SIMOVERT MASTERDRIVES VC/MC	6SN1197-0AC67-0AP0	German

Commissioning software

Additional commissioning software is available to commission induction motors connected to the SIMODRIVE drive converter system.

Order No. [MLFB] for software	6SN1153-2AX10-□AB□5
Order No. [MLFB] for documentation	6SN1197-0AA30-0□B□

Hotline

Should you have any questions, please consult the following Hotline:

A&D Technical Supports Phone: +49 (180) 5050-222
Fax: +49 (180) 5050-223
Email: adsupport@siemens.com

If you have any questions about the documentation (suggestions, corrections) please send a fax to the following fax address:

+49 (9131) 98-2176

Fax form: see the feedback page at the back of this document.

Definition of qualified personnel

For the purpose of this document and product labels, a qualified person is a person who is familiar with the installation, mounting, start-up and operation of the equipment and hazards involved. He or she must have the following qualifications:

- Trained and authorized to energize/de-energize, circuits and equipment in accordance with established safety procedures.
- Trained in the proper care and use of protective equipment in accordance with established safety procedures.
- Trained in rendering first aid.

Explanation of symbols

The following danger and warning concept is used in this document:



Danger

This symbol is always used if death, severe personal injury or substantial material damage **will** result if proper precautions are not taken.



Warning

This symbol is always used if death, severe personal injury or substantial material damage **can** result if proper precautions are not taken.



Caution

This symbol is always used if minor personal injury or material damage **can** result if proper precautions are not taken.

Caution

The warning note (without a warning triangle) means that material damage **can** occur if proper precautions are not taken.

Notice

This warning note indicates that an undesirable result or an undesirable status **can** occur if the appropriate information is not observed.

Note

In this document, it can be advantageous to observe the information provided in a Note.

Danger and warning information



Danger

- Start-up/commissioning is absolutely prohibited until it has been completely ensured that the machine, in which the components described here are to be installed, is in full compliance with the specifications of Directive 98/37/EC.
 - Only appropriately qualified personnel may commission SIMODRIVE units and AC motors.
 - This personnel must carefully observe the technical customer documentation belonging to this product and be knowledgeable about and carefully observe the danger and warning information.
 - Operational electrical equipment and motors have parts and components which are at hazardous voltage levels.
 - Hazardous axis motion can occur when working with the equipment.
 - All work must be undertaken with the system in a no-voltage condition (powered-down).
 - SIMODRIVE drive units are generally designed for operation on low-ohmic, grounded line supplies (TN line supplies). For additional information please refer to the appropriate documentation for the drive converter systems.
-



Warning

- Perfect and safe operation of these units and motors assumes professional transport, storage, mounting and installation as well as careful operator control and servicing.
 - The information provided in catalogs and quotations additionally applies to special versions of units and motors.
 - In addition to the danger and warning information/instructions in the technical customer documentation supplied, the applicable domestic, local and plant-specific regulations and requirements must be carefully taken into account.
-



Caution

- The motors can have surface temperatures of over +100° C.
 - This is the reason that temperature-sensitive components, e.g. cables or electronic components may neither be in contact nor be attached to the motor.
 - When handling cables, please observe the following:
 - They may not be damaged
 - They may not be stressed
 - They should not come into contact with rotating components.
-

Caution

- Motors should be connected-up according to the circuit diagram provided. They must not be connected directly to the three-phase supply because this will damage them.
 - SIMODRIVE drive units with induction motors are subject, as part of the routine test, to a voltage test in accordance with EN 50178. While the electrical equipment of industrial machines is being subject to a voltage test in accordance with EN60204-1, Section 19.4, all SIMODRIVE drive unit connections must be disconnected/withdrawn in order to avoid damaging the SIMODRIVE drive units.
-

Notes

- SIMODRIVE units with induction motors fulfill, when operational and in dry operating rooms, the Low-Voltage Directive 73/23/EEC.
 - SIMODRIVE units with induction motors fulfill, in the configuration specified in the associated EC Declaration of Conformity, the EMC Directive 89/336/EEC.
-

ESDS information and instructions



Caution

ElectroStatic Discharge Sensitive devices (ESDS) are individual components, integrated circuits or modules which could be damaged as a result of electrostatic fields or electrostatic discharge.

Handling ESDS boards:

- When handling components which can be destroyed by electrostatic discharge, it must be ensured that personnel, the workstation and packaging are well grounded!
 - Electronic boards may only be touched by personnel in ESDS areas with conductive flooring if
 - they are grounded with an ESDS bracelet
 - they are wearing ESDS shoes or ESDS shoe grounding strips.
 - Electronic boards may only be touched when absolutely necessary.
 - Electronic boards may not be brought into contact with plastics and articles of clothing manufactured from man-made fibers.
 - Electronic boards may only be placed on conductive surfaces (table with ESDS surface, conductive ESDS foam rubber, ESDS packing bag, ESDS transport containers).
 - Electronic boards may not be brought close to data terminals, monitors or television sets (minimum clearance >10 cm).
 - Measuring work may only be carried-out on the electronic boards, if
 - the measuring unit is grounded (e.g. via a protective conductor) or
 - when floating measuring equipment is used, the probe is briefly discharged before making measurements (e.g. a bare-metal control housing is touched).
-

Contents

1	Motor Description	1PH7/1-13
1.1	Applications and features	1PH7/1-13
1.2	Technical design	1PH7/1-14
1.3	Technical design, options	1PH7/1-16
1.4	Order number	1PH7/1-17
1.5	Rating plate data	1PH7/1-20
1.6	Cooling	1PH7/1-21
1.7	Electrical connections	1PH7/1-23
1.7.1	Connecting-up induction motors	1PH7/1-23
1.7.2	Connecting-up information	1PH7/1-24
1.7.3	Supply data for separately-driven fans	1PH7/1-26
1.8	Bearing design	1PH7/1-28
1.9	Vibration severity limit values	1PH7/1-31
1.10	Mounting	1PH7/1-32
2	Technical Data and Characteristics	1PH7/2-35
2.1	Technical data	1PH7/2-35
2.2	Power-speed and torque-speed diagrams	1PH7/2-38
2.3	Cantilever and axial force diagrams	1PH7/2-98
2.3.1	Cantilever force	1PH7/2-98
2.3.2	Axial force	1PH7/2-111
3	Motor Components	1PH7/3-117
3.1	Thermal motor protection	1PH7/3-117
3.2	Encoders	1PH7/3-119
3.3	Gearboxes	1PH7/3-121
3.3.1	Features	1PH7/3-122
3.3.2	Gearbox design	1PH7/3-124
3.3.3	Technical data	1PH7/3-125
3.3.4	Electrical connections	1PH7/3-126
3.3.5	Gearbox stage selection	1PH7/3-127
3.3.6	Lubrication	1PH7/3-128
3.3.7	Flange dimensions	1PH7/3-129
3.3.8	Connections, circulating oil lubrication, frame size 100	1PH7/3-130
3.3.9	Connections, circulating oil lubrication, frame sizes 132 and 160	1PH7/3-131
3.3.10	Gearbox dimensions	1PH7/3-132
4	Dimension Drawings	1PH7/4-135
4.1	Type of construction IM B3 with separately-driven fan	1PH7/4-136
4.2	Type of construction IM B5 with separately-driven fan	1PH7/4-148
4.3	Type of construction IM B35 with separately-driven fan	1PH7/4-152

A	References	A-167
	Index	Index-171



Motor Description

1.1 Applications and features

Applications

The 1PH7 series is suitable for the closed-loop speed controlled operation of main spindles on machine tools, transfer lines, production machines and special-purpose machines.



Fig. 1-1 1PH7 induction motors

Features

1PH7 motors are compact, force-ventilated four-pole squirrel-cage induction motors.

Depending on the shaft height, 1PH7 motors have rated powers from 3.7 up to 100 kW at rated speeds from 500 to 2500 RPM.

- Wide constant-power range
- Short length
- Full rated torque is continually available – even at standstill
- High overload capability
- Minimized disturbing envelope dimensions as a result of the integrated terminal box (for shaft heights 100–160)

Standards, regulations

The appropriate standards, regulations are directly assigned to the functional requirements.

1.2 Technical design

Table 1-1 Design features

Technical features	Version
Motor type	Induction motor
Type of construction (acc. to EN 60034-7; IEC 60034-7)	SH 100 to 132: IM B3 (not for core types); IM B5; IM B35 SH 160 to 225: IM B3; IM B35
Degree of protection (acc. to EN 60034-5; IEC 60034-5)	IP55; fan IP54
Cooling (acc. to EN 60034-6; IEC 60034-6)	Air cooled, separately-driven fan at the NDE Air flow direction: From DE to NDE
Winding insulation (acc. to EN 60034-1, IEC 60034-1)	Temperature rise class F for a cooling medium temperature of +40 °C
Thermal motor protection (acc. to EN 60034-11, IEC 60034-11)	KTY84 temperature sensor in the stator winding
Motor voltage	Max. 3-ph. 430 V AC
Sound pressure level (acc. to DIN EN ISO 1680) Tolerance +3 dB	SH 100 to 132: 70 dB (A) SH 160 75 dB (A) ¹⁾ SH 180 73 dB (A) ²⁾ SH 225 76 dB (A) ²⁾
Vibration stressing (acc. to IEC 68-2-6)	0.4 g at 63 Hz
Terminal box arrangement	Top
Cable entry (when viewing the drive end)	Power cable: at the right for all SH Signal cable: SH 100 to 160 right SH 180 to 225, left
Connection type	Motor and fan: via terminal box Encoder: via connector (17-pin, mating connector is not included in the scope of supply)
Speed encoder, integrated	Optical encoder <ul style="list-style-type: none"> Speed sensing Indirect position sensing (incremental)
Balancing (acc. to IEC 60034-14)	Standard: Half-key balancing (dynamic), Identifying symbol: H at the shaft face
Shaft end (acc. to DIN 748-3; IEC 60072-1)	Cylindrical; without keyway and without key tolerance field k6, (option, refer to Table 1-2)
Bearing version DE (Standard)	SH 100 to 160: Suitable for belt and coupling out-drives SH 180 to 225: Suitable for belt out-drives
Radial eccentricity, concentricity and axial eccentricity (acc. to DIN 42955, IEC 60072-1)	SH 100 to 160: Tolerance level R SH 180 to 225: Tolerance level N

Table 1-1 Design features, continued

Technical features	Version
Vibration severity (acc. to EN 60034-14, IEC 60034-14)	Level R; level S for core types (refer to the Order code)
Installation height above sea level (acc. to EN 60034-1, IEC 60034-1)	≤ 1000 m above sea level, otherwise power de-rating (refer to Section 1.6)
Paint finish	Without paint finish
Rating plate	A rating plate is supplied loose for each motor
Documentation supplied with the motors	Operating instructions

-
- 1) For 60 Hz operation from the line supply, a screen (on request) is available to reduce the sound pressure level.
 - 2) For shaft heights 180 and 225, noise dampening (on request) is available to reduce the sound pressure level.

1.3 Technical design, options

Table 1-2 Options

Technical features	Version
Type of construction ¹⁾	All mounting positions are possible (refer to the Planning Guide "General Part for AC Induction Motors")
Cooling ³⁾	Air flow direction from the non-drive end to drive end
Cable entry ^{2) 3)}	<ul style="list-style-type: none"> • SH 100 to 160 Power cable left, NDE or signal cable left, NDE • SH 180 to 225 Power cable left, DE NDE or signal cable right, NDE DE
Shaft end	Cylindrical (acc. to DIN 748, Part 3) with keyway and key Tolerance zone SH 100 and 132: k6 Tolerance zone SH 160 up to 225: m6
Bearing version	<ul style="list-style-type: none"> • SH 100 to 160, standard • SH 180 to 225 Bearings for a coupling out-drive; Bearings for a coupling out-drive and increased speed (only for SH 180); Bearings for increased cantilever force
Radial eccentricity, concentricity and axial eccentricity (acc. to DIN 42955, IEC 60072-1)	Shaft Heights 100 to 160: Standard SH 180 to 225: Tolerance, level R
Vibration severity (acc. to EN 60034-14, IEC 60034-14)	SH 100 to 160: Level S ⁴⁾ ; Level SR (=S/1.6) SH 180 to 225: Only for coupling out-drive, levels S and SR
Mounted/integrated components	The motors can be supplied complete with mounted gearbox
Seal	SH 100 to 160: DE flange with shaft seal (if occasional oil drops or oil mist lubricate the sealing ring)

1) For shaft heights 180 and 225, it must be ensured that the correct hoisting concept is applied

2) Only in the specified combination

3) Not for core types

4) For core types, included in the basic version

1.4 Order number

Motor type, design features and additional data are coded in the Order designation.

SH 100 to 160 standard version

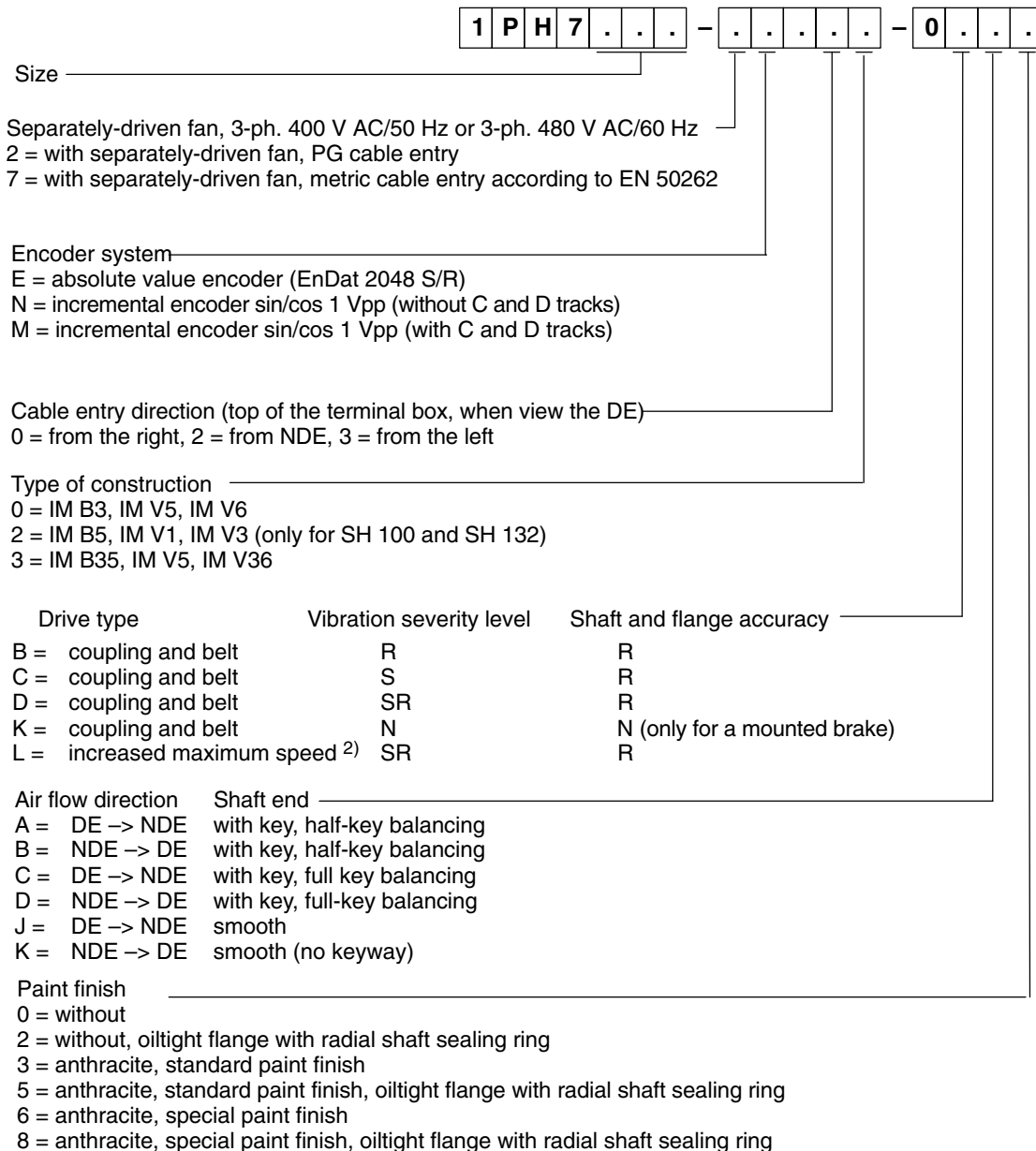

1) Not for every shaft height

2) Version for increased maximum speed only in conjunction with vibration severity level SR.

Option not possible for:
 – prepared for mounting a ZF gearbox
 – shaft seal

1.4 Order number

Shaft Heights 100 to 160, core versions

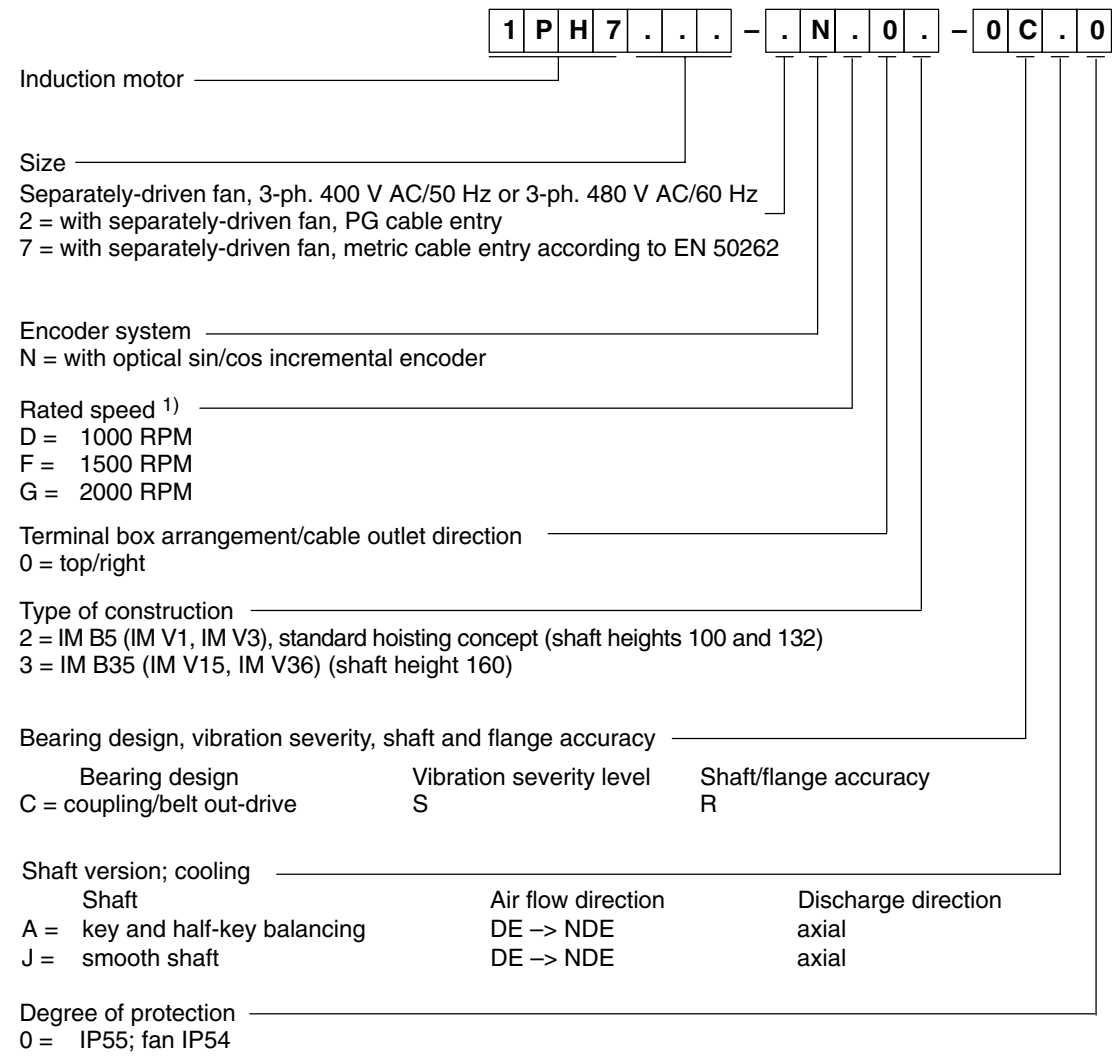

1) Not for every shaft height

Shaft heights 180 to 225

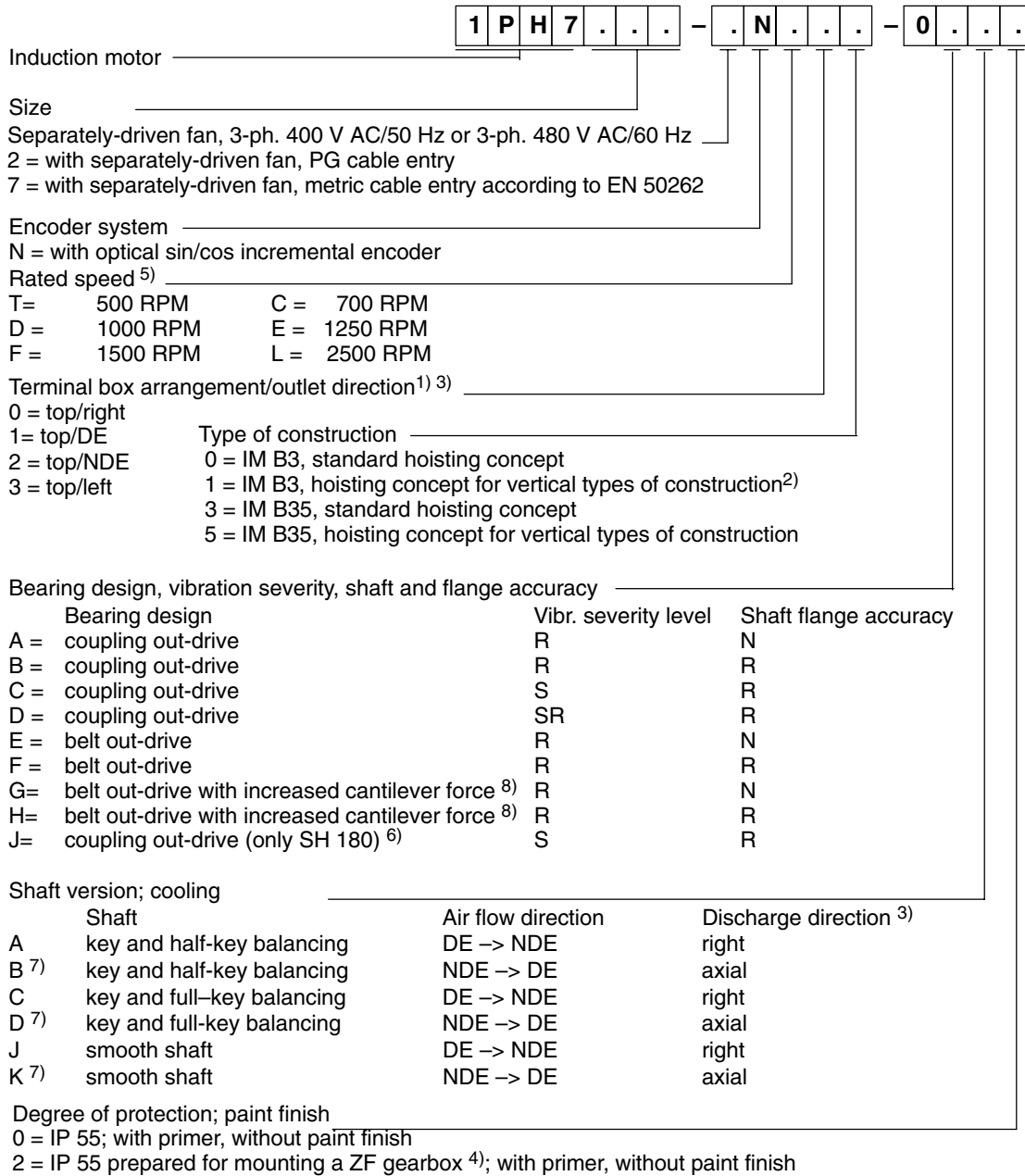

- 1) Signal connector outlet, shifted through 180°
- 2) Not IM V6 (shaft facing upwards)
- 3) When viewing the drive end
- 4) Only in conjunction with type of construction IM B35 and IM V15, bearing designs for coupling out-drive, vibration severity level R, shaft and flange accuracy R, key and full-key balancing
- 5) Not for every shaft height
- 6) Version for increased max. speed ($n_{max}=7000$ RPM); not for mounted gearbox
- 7) The motor is longer (refer to the dimension drawings)
- 8) $n_{max}=4500$ for SH 225

1.5 Rating plate data

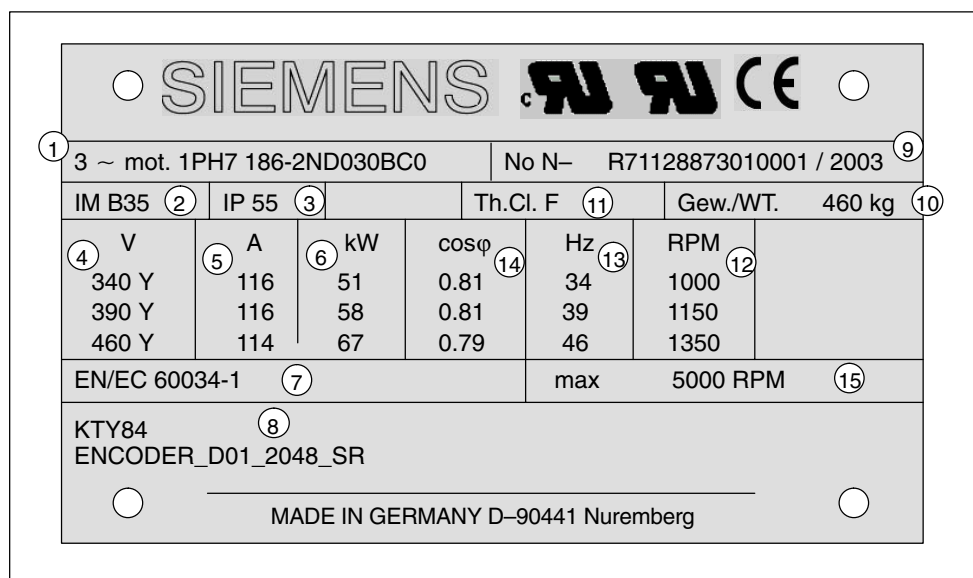

Fig. 1-2 Rating plate (example for 1PH7186)

Table 1-3 Description of the rating plate data

Item	Description/technical data
1	Motor type: Induction motor
2	Type of construction
3	Degree of protection
4	Rated voltage [V] and winding configuration
5	Rated current [A]
6	Rated power [kW]
7	Standards and regulations
8	Code, encoder type, temperature sensor
9	ID No., serial number
10	Motor weight [kg]
11	Temperature class
12	Rated speed [RPM]
13	Rated frequency [Hz]
14	Power factor [$\cos\phi$]
15	Maximum speed [RPM]

1.6 Cooling

Note

1PH7 main spindle motors are force-ventilated. When mounting the motors, it must be ensured that the motor can be well ventilated. This is especially true when mounting the motors in enclosures. It is not permissible that the hot discharged air is drawn in again.



Caution

Temperatures of over 100 °C can occur at the surface of the motor.

Mounting a fan and minimum clearance to the customer's mounted parts and components

The fan is axially mounted at the NDE.

The minimum clearance to the customer's mounted parts and components and the air discharge opening as well as the minimum clearance S between the air intake and air discharge openings and adjacent components must be observed and maintained (refer to Table 1-4).

Table 1-4 Minimum clearances

Shaft height [mm]	Clearance to the customer's mounted parts and components [mm]	Clearance S [mm]
100	30	30
132	60	60
160	80	80
180	100	80
225	100	80

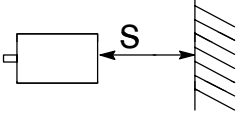

For air-cooled motors, the cooling ducts, through which the ambient air flows, should be regularly cleaned depending on the degree of pollution at the mounting location. These air ducts can be cleaned, e.g. using dry, oil-free compressed air. For totally-enclosed fan-cooled motors, the inside of the motor can be cleaned during standard service/maintenance intervals.

Air flow direction

Standard: from DE to NDE

Option: from NDE to DE (not for core types)

for SH 180 and SH 225, the motor length changes (dimension drawing)

Air discharge

SH 100 to 160: axial

SH 180 and 225: radial to the right (when viewing the DE); the fan can be rotated through 4 x 90°

1.6 Cooling

Ambient/cooling medium temperature

Operation: T = -15 °C to +40 °C (without any restrictions)

Bearing design: T = -20 °C to +70 °C

All of the Catalog data refer to an ambient temperature of 40 °C, mounted so that the motors are not thermally insulated and an installation altitude up to 1000 m above sea level.

If the ambient conditions differ (ambient temperature > 40 °C or the installation altitude > 1000 m above sea level), the permissible torques and power ratings must be reduced (refer to the factors from Table 1-5).

Ambient temperatures and installation altitudes are rounded-off to 5 °C or 500 m.

Table 1-5 Factors for reducing the torque/power acc. to EN 60034-6

Installation height above sea level	Ambient temperature in °C		
	40	45	50
1000	1.00	0.96	0.92
1500	0.97	0.93	0.89
2000	0.94	0.90	0.86
2500	0.90	0.86	0.83
3000	0.86	0.82	0.79
3500	0.82	0.79	0.75
4000	0.77	0.74	0.71

Air flow

Table 1-6 Air flow for 1PH7 motors

Shaft height [mm]	Voltage [V]	Frequency [Hz]	Approx. air flow [l/sec]
100	400	50	40
	400 / 480	60	50
132	400	50	100
	400 / 480	60	130
160	400	50	150
	400 / 480	60	190
180	400	50	190
	400 / 480	60	190
225	400	50	360
	400 / 480	60	360

1.7 Electrical connections

1.7.1 Connecting-up induction motors

Note

The motors can be fed from a DC link voltage of up to 700 V DC. For shaft heights 180 and 225, the appropriate version must be selected.

Table 1-7 Overview, connection system for 1PH7 motors

SH	Number of main terminals	Max. cross-section that can be connected	Terminal strip for temperature sensor	PE connection size/ cable lug width
100	6 x M5	25 mm ²	3 terminals	M5/9 mm
132	6 x M6	35 mm ² with cable lug connection	3 terminals	M6/15 mm
160	6 x M6	50 mm ² with cable lug connection	3 terminals	M6/18 mm ²⁾
180	3 x M12	2 x 50 mm ² with cable lug connection	4 terminals	Without cable lug using a terminal clamp ¹⁾
225	3 x M12	2 x 50 mm ² with cable lug connection	4 terminals	Without cable lug using a terminal clamp ¹⁾

Power cable

The power cables for 1PH motors are selected according to the rated motor current I_N at +40 °C according to Table 1-8.



Caution

Carefully observe the current which the motor draws for your particular application! Adequately dimension the connecting cables according to IEC 60204-1.

Note

The cables are available in a UL version or for higher mechanical requirements. Technical data, refer to Catalog, Chapter "Connection System".

-
- 1) Cable cross-section, corresponding to the line conductor cross-section
 2) Cable lug acc. to DIN 46234

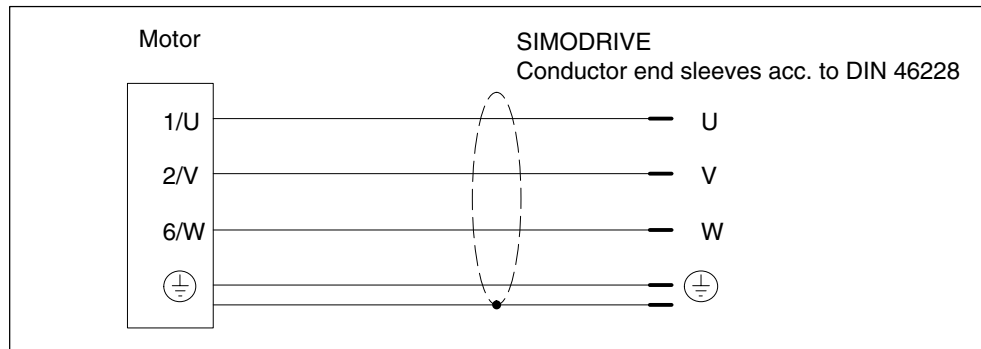

Fig. 1-3 Power cable

1.7.2 Connecting-up information

Note

The overall system compatibility is only guaranteed when using shielded power cables.

Shields must be incorporated in the protective grounding concept. Protective ground should be connected to conductors that are open-circuit and that are not being used and also electrical cables that can be touched. If the brake feeder cables in the SIEMENS cable accessories are not used, then the brake conductor cores and shields must be connected to the cabinet ground (open-circuit cables result in capacitive charges!).



Warning

- Before carrying-out any work on the induction motor, please ensure that it is powered-down and the system is locked-out so that the motor cannot re-start!
 - Please observe the rating plate data and circuit diagram in the terminal box. Appropriately dimension the connecting cables.
-
- Twisted or three-core cables with additional ground conductor should be used as motor feeder cables. The insulation should be removed from the ends of the conductors so that the remaining insulation extends up to the cable lug or terminal.
 - The connecting cables should be freely arranged in the terminal box so that the protective conductor has an overlength and the cable conductor insulation cannot be damaged. Connecting cables should be appropriately strain relieved.
 - Please ensure that the following minimum air distances are maintained: Supply voltages up to 500 V: Minimum air distance 4.5 mm
 - After connecting-up, it should be checked, whether
 - the inside of the terminal box is clean and free of any cable pieces,
 - all of the terminal screws are screwed tightly,
 - minimum air clearances are maintained,

- the cable entries are reliably sealed,
- unused cable entry glands are closed and the caps are tightly screwed in and
- all of the sealing surfaces are in a good condition.

Press drives

Note

For press drives with acceleration rates > 2 g, special measures are required. Please contact your local Siemens office.

Cross-sections

When connecting cables to the terminal board, the connecting cables must be dimensioned corresponding to the rated current and the size of the cable lugs must match the dimensions of the terminal studs.

Table 1-8 Current load capability acc. to EN 60204-1 for PVC-insulated cables with copper conductors at a 40°C ambient temperature and routing type C (cables and conductors retained to panels/walls and cable ducts)

I_{rms} at +40 °C [A]	Required cross-section [mm ²]	Comments
11.7	1	Correction factors with reference to ambient temperature and routing type are specified in EN60204-1.
15.2	1.5	
21	2.5	
28	4	
36	6	
50	10	
66	16	
84	25	
104	35	
123	50	
155	70	
192	95	
221	120	

Assignment, terminal boxes and max. cross-section

Table 1-9 Terminal box assignment, max. cable cross-sections that can be connected

Shaft height	Motor type	Terminal box type	Number of main terminals	Max. connectable cross-section per terminal [mm ²]
100	1PH710□-2□□	integrated	6 x M5	25
132	1PH713□-2□□	integrated	6 x M6	35
160	1PH716□-2□□	integrated	6 x M6	50
180	1PH7184-2□□	1XB7322	3 x M12	2 x 50
	1PH7184-2□B	1XB7322	3 x M12	2 x 50
	1PH7184-2□D	1XB7322	3 x M12	2 x 50
	1PH7184-2□F	1XB7422	3 x M12	2 x 70
	1PH7184-2□L	1XB7422	3 x M12	2 x 70
	1PH7186-2□E	1XB7322	3 x M12	2 x 50
	1PH7186-2□D	1XB7322	3 x M12	2 x 50
225	1PH7186-2□T	1XB7322	3 x M12	2 x 50
	1PH7224-2□C	1XB7322	3 x M12	2 x 50
	1PH7224-2□D	1XB7322	3 x M12	2 x 50
	1PH7224-2□F	1XB7322	3 x M12	2 x 50

1.7.3 Supply data for separately-driven fans

Table 1-10 Supply data for separately-driven fans

Shaft height [mm]	Air flow direction	Max. current drain at		
		400 V/50 Hz (±10%)	400 V/60 Hz (±10%)	480 V/60 Hz (+5%, -10%)
100	DE → NDE	0.20	0.13	0.20
	NDE → DE	0.19	0.13	0.18
132	DE → NDE	0.37	0.24	0.33
	NDE → DE	0.35	0.24	0.32
160	DE → NDE	0.30	0.33	0.34
	NDE → DE	0.29	0.31	0.33
180	DE → NDE	0.8	1.1	1.1
	NDE → DE	0.8	1.1	1.1
225	DE → NDE	2.8	2.8	2.8
	NDE → DE	1.9	2.2	2.2

In order to minimize the motor noise at standstill, the fan can be shut down at $n < n_{min}$ and when the controller enable has been withdrawn.

Recommended connection

The fan is connected through the terminal box. The fan should be operated through motor protection circuit-breakers.

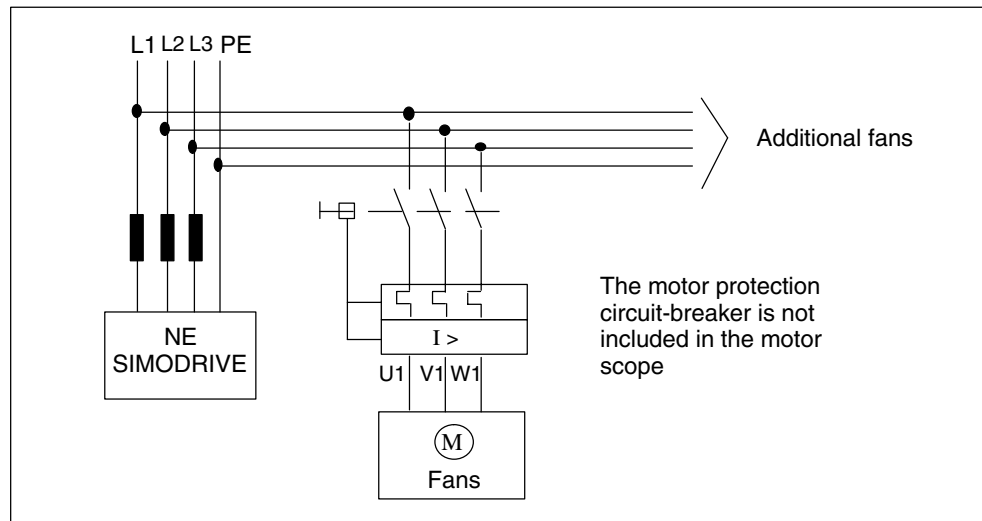

Fig. 1-4 Recommended connection

Example of a fan control

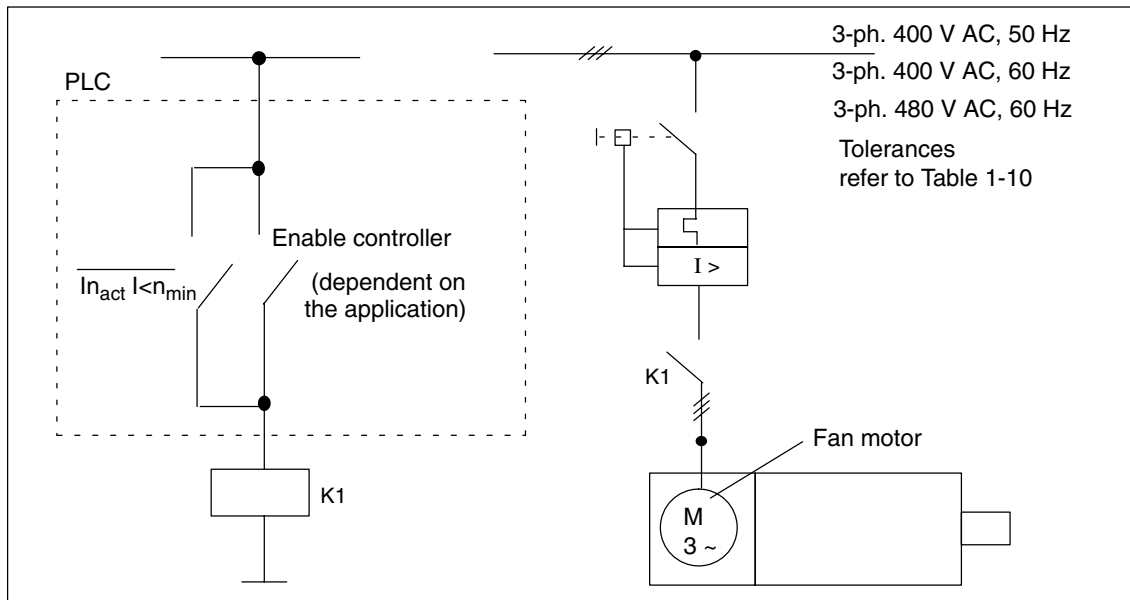

Fig. 1-5 Example, fan control

1.8 Bearing design

Out-drive types and bearing versions

1PH7 induction motors are suitable for coupling and belt out-drives. The bearing versions and their applications are summarized in Table 1-11.

Table 1-11 Out-drive type with the appropriate bearing version

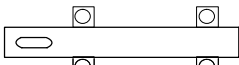
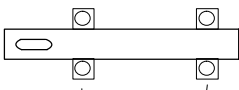
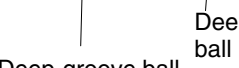
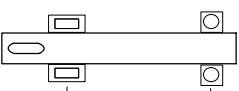
Applications	Bearing version	
<ul style="list-style-type: none"> • Coupling out-drive • Planetary gear • Low cantilever forces 	<p>SH 100 to SH 160</p>  <p>Deep-groove ball bearings</p>	 <p>SH 180 SH 225</p> <p>Deep-groove ball bearings Deep-groove ball bearings</p>
<ul style="list-style-type: none"> • Belt out-drive with normal cantilever force • Pinion out-drive with straight teeth • Belt out-drive with increased cantilever force 	 <p>Deep-groove ball bearings</p> <p>Deep-groove ball bearings</p>	 <p>SH 180 SH 225</p> <p>Deep-groove ball bearings Cylindrical-roller bearing</p>

Bearing change intervals (t_{LW}) SH 100 to 225

The values specified in Tables 1-12 and 1-13 are valid for the following conditions:

- Coupling and belt out-drives
- Horizontal mounting
- The bearing change intervals are reduced for unfavorable operating conditions, for example
 - Average speed > as specified in Table 1-12
 - Vibration and shock load
 - Frequent reversing operation

Table 1-12 Recommended bearing change intervals

Type	Average operating speed ¹⁾ n_m [RPM]		Continuous speed n_{s1} [RPM]
1PH710□	$n_m \leq 2500$	$2500 < n_m < 6000$	$n_{s1} \leq 5500$
1PH713□	$n_m \leq 2000$	$2000 < n_m < 5500$	$n_{s1} \leq 4500$
1PH716□	$n_m \leq 1500$	$1500 < n_m < 4500$	$n_{s1} \leq 3700$
1PH718□	$n_m \leq 1500$	$1500 < n_m < 4000$	$n_{s1} \leq 3500$ ²⁾
1PH7224	$n_m \leq 1500$	$1500 < n_m < 3500$	$n_{s1} \leq 3100$ ²⁾
t_{LW} [h]	16000	8000	8000

Table 1-13 Recommended bearing change intervals for increased maximum speeds

Type	Average operating speed n_m [RPM]	Continuous speed n_{s1} [RPM]
1PH710□	$8000 \leq n_m \leq 12000$	$n_{s1} \leq 10000$
1PH713□	$6000 \leq n_m \leq 10000$	$n_{s1} \leq 8500$
1PH716□	$5000 \leq n_m \leq 8000$	$n_{s1} \leq 7000$
1PH718□	$1500 \leq n_m \leq 7000$	$n_{s1} \leq 4500$
1PH7224	$1500 \leq n_m \leq 5500$	$n_{s1} \leq 3600$
t_{LW} [h]	8000	8000

1) A speed duty cycle with low speeds and standstill periods is assumed.

2) For increased cantilever force:
 SH 180: $n_{s1} \leq 3000$ RPM
 SH 225: $n_{s1} \leq 2700$ RPM

Continuous speed n_{S1}

The max. permissible continuous operating speed n_{S1} depends on the bearings and the shaft height (refer to Table 1-14).

Table 1-14 Assignment, max. speed to shaft height and bearing design

SH [mm]	Coupling out-drive, belt out-drive [RPM]		Belt out-drive with increased cantilever force [RPM]		Increased max. speed [RPM]	
	$n_{max}^{1)}$	$n_{S1}^{2)}$	$n_{max}^{1)}$	$n_{S1}^{2)}$	$n_{max}^{1)}$	$n_{S1}^{2)}$
100	9000	5500	–	–	12000	10000
132	8000	4500	–	–	10000	8500
160	6500	3700	–	–	8000	7000
180	5000	3500	5000	3000	7000 ³⁾	4500 ³⁾
225	4500	3100	4500	2700	5500 ³⁾	3600 ³⁾

Important

If the motor is operated at speeds between n_{S1} and n_{max} , then a speed duty cycle is assumed that has time components with low speed and standstill in order that the lubricant being used can re-generate.

-
- 1) Mechanical limiting speed (permissible for 10 min. cycle with: 3 min n_{max} , 6 min $2/3 n_{max}$, 1 min standstill)
 - 2) Max. continuous operating speed
 - 3) Only coupling out-drive is permissible

1.9 Vibration severity limit values

The vibration severity limit values are identical within the 1PH□ series!

The diagrams are included in the Planning Guide, "General Part for Induction Motors".

Note

A foot support is required for the following motors in order to maintain the vibration severity limit values:

SH 160 to SH 225 for type of construction IM B35

Permissible induced vibrations

In order to ensure perfect functioning and a long lifetime, the vibration values, specified in the following table should not be exceeded at the motor.

Table 1-15 Vibration values

Vibration frequency	Vibration values for shaft height		
		SH 100 to 160	SH 180 and 225
< 6.3 Hz	Vibration travel s [mm]	≤ 0.16	≤ 0.25
6.3...63 Hz	Vibration velocity v_{aM} [mm/s]	≤ 4.5	≤ 7.1
> 63 Hz	Vibration acceleration a [m/s^2]	≤ 2.55	≤ 4.0

1.10 Mounting

Mounting instructions



Warning

These motors are electrically operated. When electrical equipment is operated, certain parts of these motors are at hazardous voltage levels. If this motor is not correctly handled/operated, this can result in death or severe bodily injury as well as significant material damage. Please carefully observe the warning information in this section on the product itself.

- Only **qualified personnel** may carry-out service or repair work on this motor.
 - Before starting any work, the motor must be disconnected from the line supply and grounded.
 - Only spare parts, certified by the manufacturer, may be used.
 - The specified service/maintenance intervals and measures as well as the procedures for repair and replacement must be carefully maintained and observed.
-



Warning

- When transporting the motors, use all of the hoisting lugs provided!
 - A suitable crane/lifting device must be used. Incorrect execution, unsuitable or damaged equipment and resources can result in injury and material damage. The hoisting and transport equipment as well as the load suspension equipment must be in full compliance with the appropriate regulations.
 - All work should be undertaken with the system in a no-voltage condition!
 - The motor should be connected up according to the circuit diagram provided.
 - In the terminal box it must be ensure that the connecting cables are insulated with respect to the terminal board cover.
 - After the motor has been installed, the brake (if one is used) must be checked to ensure that it is functioning perfectly!
-

Note

For SH 180 and 225, flange mounting is only possible using studs and nuts. Clearance M1 for threading the nut between the motor flange and motor frame acc. to DIN 42948 (refer to Table 1-16).

Table 1-16 Flange mounting with studs and nuts

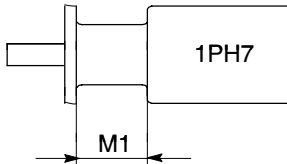
Shaft height	M1 [mm]	
100	44	
132	50	
160	65	
180	36	
225	40	

Cable outlet NDE

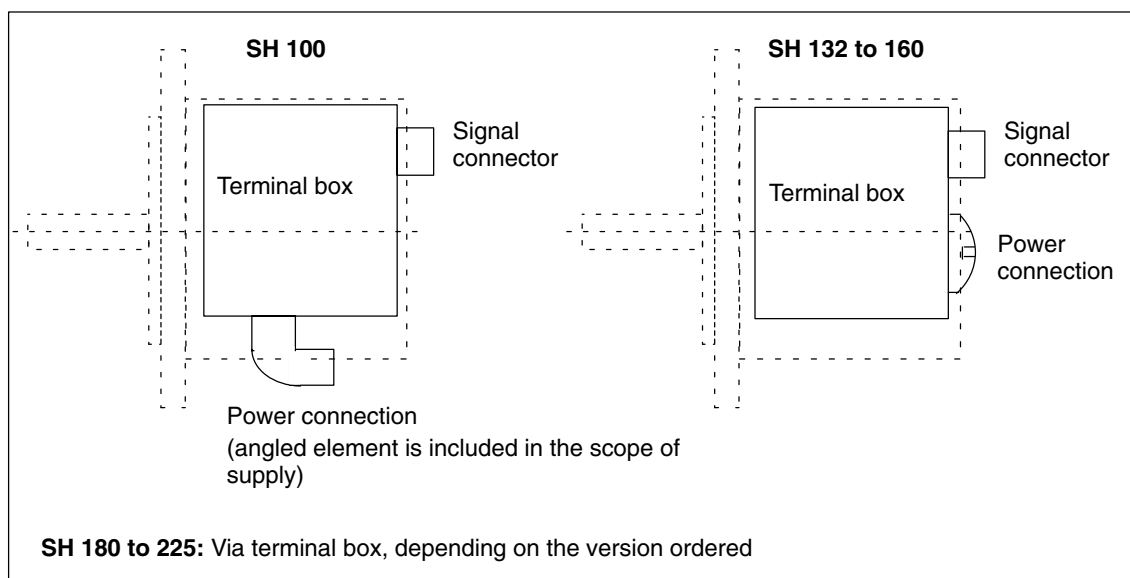

Fig. 1-6 Cable outlet

Mounting information and instructions

The following mounting instructions must be carefully observed:

- For high-speed machines, we recommend that the complete unit is dynamically balanced after couplings or belt pulleys have been mounted.
- Use suitable equipment when mounting drive elements. Use the thread at the shaft end.
- Do not apply any blows or axial pressure to the shaft end.
- Especially for high-speed motors with flange mounting, it is important that the mounting is stiff in order to locate any resonant frequency as high as possible so that it remains above the maximum rotational frequency.



Caution

Liquid must be prevented from collecting at the flange – both for vertical as well as horizontal mounting positions. If liquid is not prevented from collecting, then it can be assumed that it will enter the inside of the motor.

Notice

1PH7 main spindle motors are force-ventilated. When mounting the motors, it must be ensured that the motor can be well ventilated. This is especially true when mounting the motors in enclosures. It is not permissible that the hot discharged air is drawn in again.

Notice

Motors must be carefully mounted on adequately stiff foundations or bedplates. Additional elasticities of the foundation/bedplates can result in resonance effects of the natural frequency at the operating speed and therefore result in inadmissibly high vibration values.

The magnitude of the natural frequency when the motor is mounted depends on various factors and can be influenced by the following points:

- Mechanical transmission elements (gearboxes, belts, couplings, pinions, etc.)
- Stiffness of the machine design to which the motor is mounted
- Stiffness of the motor in the area around the foot or customer flange
- Motor weight
- Machine weight and the weight of the mechanical system in the vicinity of the motor
- Damping properties of the motor and the machine tool
- Mounting type, mounting position (IM B3; IM B5; IM B35; IM V1; etc.)
- Motor weight distribution, i.e. length, shaft height

After the motors have been mounted, the caps for the screw holes in the mounting feet must be re-located.

■

Technical Data and Characteristics

2.1 Technical data

For a description of the codes used in the table header, refer to Table 2-3. s with a gray background are core types additional information on the order designation (MLFB), refer to Section 1.4 or Catalog NC 60.

Table 2-1 Technical data 1PH7

Order designation 1PH7	P_N [kW]	n_N [RPM]	$n_{max}^{1)}$ [RPM]	M_N [Nm]	I_N [A]	Increased n_{max} [RPM]	I_0 A	U_N V	J [kgm ²]
Shaft height 100 mm									
1PH7101-□NF□□	3.7	1500	9000	24	10	12000	5.9	350	0.017
1PH7103-□ND□□	3.7	1000	9000	35	10	12000	4.8	343	0.017
1PH7103-□NF□□	5.5	1500	9000	35	13	12000	5.4	350	0.017
1PH7103-□NG□□	7.0	2000	9000	33	17.5	12000	8.3	343	0.017
1PH7105-□NF□□	7.0	1500	9000	45	17.5	12000	9.4	346	0.029
1PH7107-□ND□□	6.25	1000	9000	60	17.5	12000	8.9	319	0.029
1PH7107-□NF□□	9.0	1500	9000	57	23.5	12000	11.0	336	0.029
1PH7107-□NG□□	10.5	2000	9000	50	26	12000	12.2	350	0.029
Shaft height 132 mm									
1PH7131-□NF□□	11	1500	8000	70	24	10000	8.4	350	0.076
1PH7133-□ND□□	12.0	1000	8000	115	30	10000	12.7	336	0.076
1PH7133-□NF□□	15	1500	8000	95	34	10000	14.0	346	0.076
1PH7133-□NG□□	20.0	2000	8000	95	45	10000	17.4	350	0.076
1PH7135-□NF□□	18.5	1500	8000	118	42	10000	17.0	350	0.109
1PH7137-□ND□□	17.0	1000	8000	162	43	10000	18.5	322	0.109
1PH7137-□NF□□	22.0	1500	8000	140	57	10000	22.8	308	0.109
1PH7137-□NG□□	28.0	2000	8000	134	60	10000	21.4	350	0.109

2.1 Technical data

Table 2-1 Technical data 1PH7, continued

Order designation 1PH7	P _N [kW]	n _N [RPM]	n _{max} ¹⁾ [RPM]	M _N [Nm]	I _N [A]	Increased n _{max} [RPM]	I ₀ A	U _N V	J [kgm ²]
Shaft height 160 mm									
1PH7163-□NB□□	12.0	500	6500	229	30	8000	12.5	339	0.19
1PH7163-□ND□□	22.0	1000	6500	210	55	8000	24.1	315	0.19
1PH7163-□NF□□	30.0	1500	6500	191	72	8000	30.1	319	0.19
1PH7163-□NG□□	36.0	2000	6500	172	85	8000	37.2	333	0.19
1PH7167-□NB□□	16.0	500	6500	306	37	8000	12.7	350	0.23
1PH7167-□ND□□	28.0	1000	6500	267	71	8000	33.1	312	0.23
1PH7167-□NF□□	37.0	1500	6500	236	82	8000	31.9	350	0.23
1PH7167-□NG□□	41.0	2000	6500	196	89	8000	39.7	350	0.23
Shaft height 180 mm									
1PH7184-□NT□□	21.5	500	5000	410	76	7000	40	235	0.5
1PH7184-□ND□□	39	1000	5000	372	90	7000	42	335	0.5
1PH7184-□NE□□	40.0	1250	5000	305	85	7000	46.2	380	0.5
1PH7184-□NF□□	51	1500	5000	325	120	7000	64	335	0.5
1PH7184-□NL□□	78	2500	5000	298	171	7000	77	340	0.5
1PH7186-□NT□□	29.6	500	5000	565	106	7000	56	228	0.67
1PH7186-□ND□□	51	1000	5000	487	116	7000	58	340	0.67
1PH7186-□NE□□	60.0	1250	5000	458	117	7000	63	400	0.67
Shaft height 225 mm²⁾									
1PH7224-□NC□□	55.0	700	4500	750	114	5500	63.5	380	1.48
1PH7224-□ND□□	71.0	1000	4500	678	161	5500	78.5	335	1.48
1PH7224-□NF□□	100.0	1500	4500	636	185	5500	73	385	1.48

1) For continuous operation (with 30% n_{max}, 60% n_{max}, 10 % standstill) for a load duty cycle of 10 min., max. continuous speed and bearing change intervals, refer to Section 1.4

2) For bearings for increased cantilever force n_{max}=4500 RPM

Table 2-2 Technical data - drive converter assignment 1PH7

Motor type 1PH7...	n _N	n _{max} 1)	M _N	Rated motor power acc. to EN 60034-1			Rated motor current for acc. to EN 60034-1			Drive converter module for acc. to EN 60034-1				
				P _N [kW]			I _N [A]			[A]				
				Duty type	S6-60 %	S6-40 %	S6-25 %	S1	S6-60 %	S6-40 %	S6-25 %	S1	S6-60 %	S6-40 %
101-NF_	1500	9000	24	3.7	4.5	5.25	6.25	10	11.5	12.5	15	24/32/32	24/32/32	24/32/32
103-ND_	1000		35	3.7	4.5	5.25	-	10	11.5	13	-	24/32/32	24/32/32	24/32/32
103-NF_	1500		35	5.5	6.7	7.7	9.0	13	16	18	20.5	24/32/32	24/32/32	24/32/32
103-NG_	2000		33	7	8.5	10	11.5	17.5	20.5	23.5	26	24/32/32	24/32/32	24/32/32
105-NF_	1500		45	7	8.5	10	12.5	17.5	21	23.5	28	24/32/32	24/32/32	24/32/32
107-ND_	1000		60	6.25	7.5	8.8	10.5	17.5	20.5	23	26.5	24/32/32	24/32/32	24/32/32
107-NF_	1500		57	9	11	13	16	23.5	27.5	31	37	30/40/51	30/40/51	30/40/51
107-NG_	2000		50	10.5	12.5	14.5	17.5	26	28.5	33	38	30/40/51	30/40/51	30/40/51
131-NF_	1500	8000	70	11	13.5	16.5	20	24	29	34	41	24/32/32	30/40/51	30/40/51
133-ND_	1000		115	12	15	18.5	22	30	36	43	50	30/40/51	45/60/76	45/60/76
133-NF_	1500		95	15	18.5	23	27	34	41	49	56	45/60/76	45/60/76	45/60/76
133-NG_	2000		95	20	25	30	36	45	54	63	73	45/60/76	60/80/102	60/80/102
135-NF_	1500		118	18.5	23	28	33	42	50	58	67	45/60/76	45/60/76	60/80/102
137-ND_	1000		162	17	20.5	25	29	43	50	60	68	45/60/76	45/60/76	60/80/102
137-NF_	1500		140	22	27.5	33	40	57	68	79	92	60/80/102	60/80/102	85/110/127
137-NG_	2000		134	28	35	43	50	60	73	87	100	60/80/102	85/110/127	85/110/127
163-NB_	500	6500	229	12	15	18	-	30	36	42	-	30/40/51	45/60/76	-
163-ND_	1000		210	22	27	33	40	55	65	77	93	60/80/102	60/80/102	85/110/127
163-NF_	1500		191	30	37	45	54	72	86	102	120	85/110/127	85/110/127	120/150/193
163-NG_	2000		172	36	44	52	62	85	100	114	133	85/110/127	85/110/127	120/150/193
167-NB_	500		306	16	19.5	24	-	37	44	53	-	45/60/76	45/60/76	-
167-ND_	1000		267	28	34.5	42	50	71	85	100	117	85/110/127	85/110/127	120/150/193
167-NF_	1500		236	37	46	56	67	82	97	115	134	85/110/127	85/110/127	120/150/193
167-NG_	2000		196	41	51	61	74	89	106	124	145	120/150/193	120/150/193	120/150/193
184-NT_	500	5000	411	21.5	26.5	30.5	35	76	90	103	118	85/110/127	85/110/127	85/110/127
184-ND_	1000		372	39	48	58	-	90	106	126	-	120/150/193	120/150/193	-
184-NE_	1250		306	40	50	56	66.2)	85	100	110	127.2)	85/110/127	85/110/127	-
184-NF_	1500		325	51	68	81	-	120	149	174	-	120/150/193	200/250/257	-
184-NL_	2500		298	78	97	115	-	172	204	237	-	200/250/257	200/250/257	-
186-NT_	500		565	29.6	36.5	43	54.2)	106	126	147	186.2)	120/150/193	120/150/193	-
186-ND_	1000		487	51	65	77	-	118	141	164	-	200/250/257	200/250/257	-
186-NE_	1250		458	60	71	80	106.2)	120	135	150	193.2)	120/150/193	120/150/193	-
224-NC_	700	4500	750	55	66.4	75	98.2)	117	135	149	193.2)	120/150/193	120/150/193	-
224-ND_	1000		678	71	88	105	-	164	190	222	-	200/250/257	200/250/257	-
224-NF_	1500		637	100	126	136	141.2)	188	230	248	257.2)	200/250/257	200/250/257	-

1) Max. speed for S1 and S6 power, refer to P-n diagram, Section 2.1
 2) at S6-16%

2.2 Power-speed and torque-speed diagrams

AC s for main spindle drives must be continually cooled in operation, independent of the operating mode/duty type.

Notes on the diagrams

The dotted lines in the diagrams indicate the power limit of the particular drive converter for the specified AC motor. The power module is specified.

The power values for duty type S6 with a relative power-on duration of 25 %, 40 % and 60 % are specified (load duty cycle, 10 min).

Speeds designated with¹⁾ are optional.

Table 2-3 Explanation of the codes used

Abbreviation	Units	Description
P_N	kW	Rated power
n_N	RPM	Rated speed
M_N	Nm	Rated torque
I_N	A	Rated current
n_{max}	RPM	Maximum rotational speed
I_0	A	Standstill current
U_N	V	Rated voltage
T_{th}	min	Thermal time constant
J	kgm ²	Moment of inertia
m	kg	Weight

Table 2-4 Induction motor 1PH7101-□NF□□

P_N [kW]	n_N [RPM]	M_N [Nm]	I_N [A]	n_{max} [RPM]	T_{th} [min]	J [kgm ²]	m [kg]
3.7	1500	24	10	9000	20	0.017	40

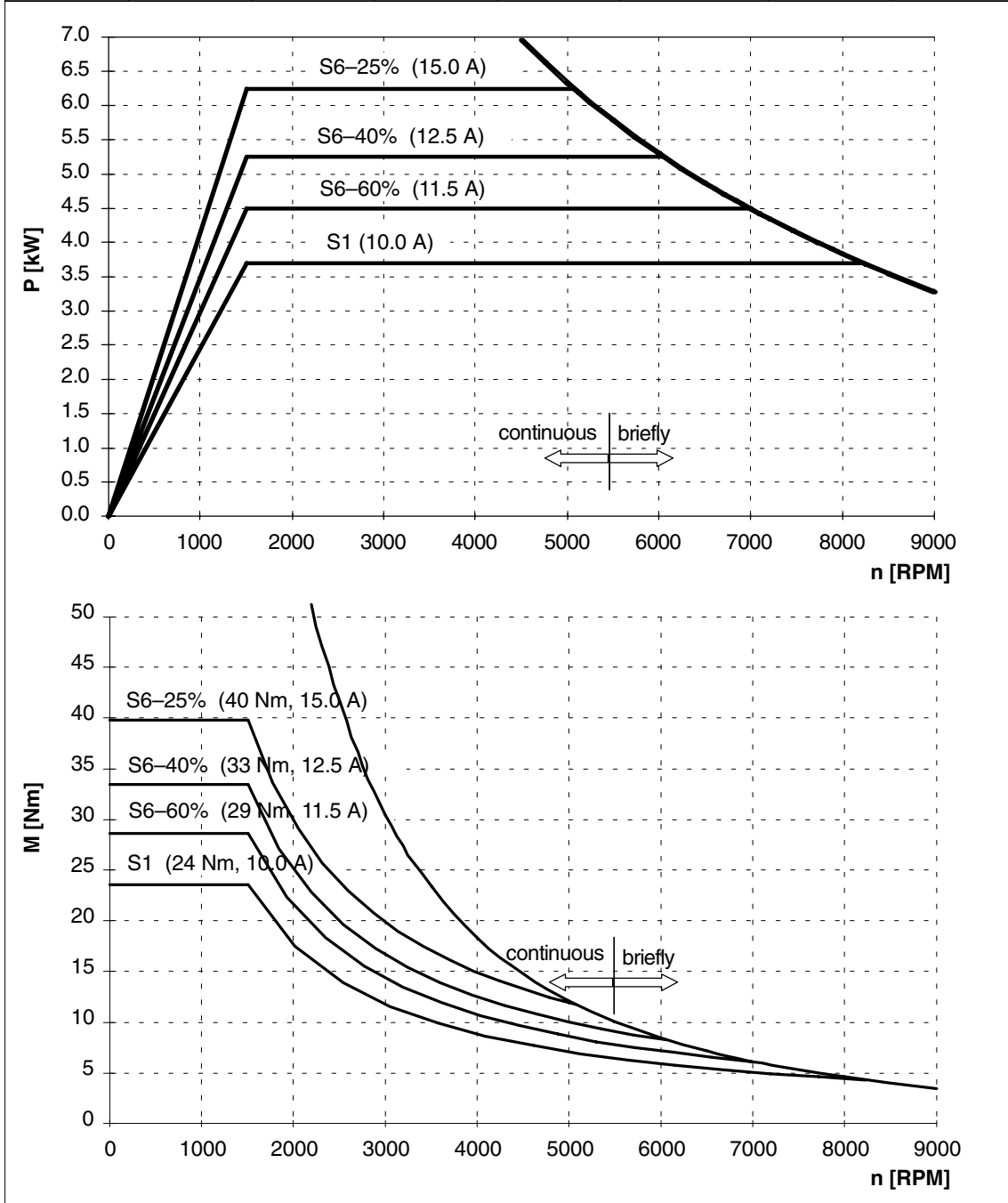

Fig. 2-1 1PH7101-□NF□□

2.2 Power-speed and torque-speed diagrams

Table 2-5 Induction motor 1PH7101-□NF□□-0L

P_N [kW]	n_N [RPM]	M_N [Nm]	I_N [A]	n_{max} [RPM]	T_{th} [min]	J [kgm ²]	m [kg]
3.7	1500	24	10	12000	20	0.017	40

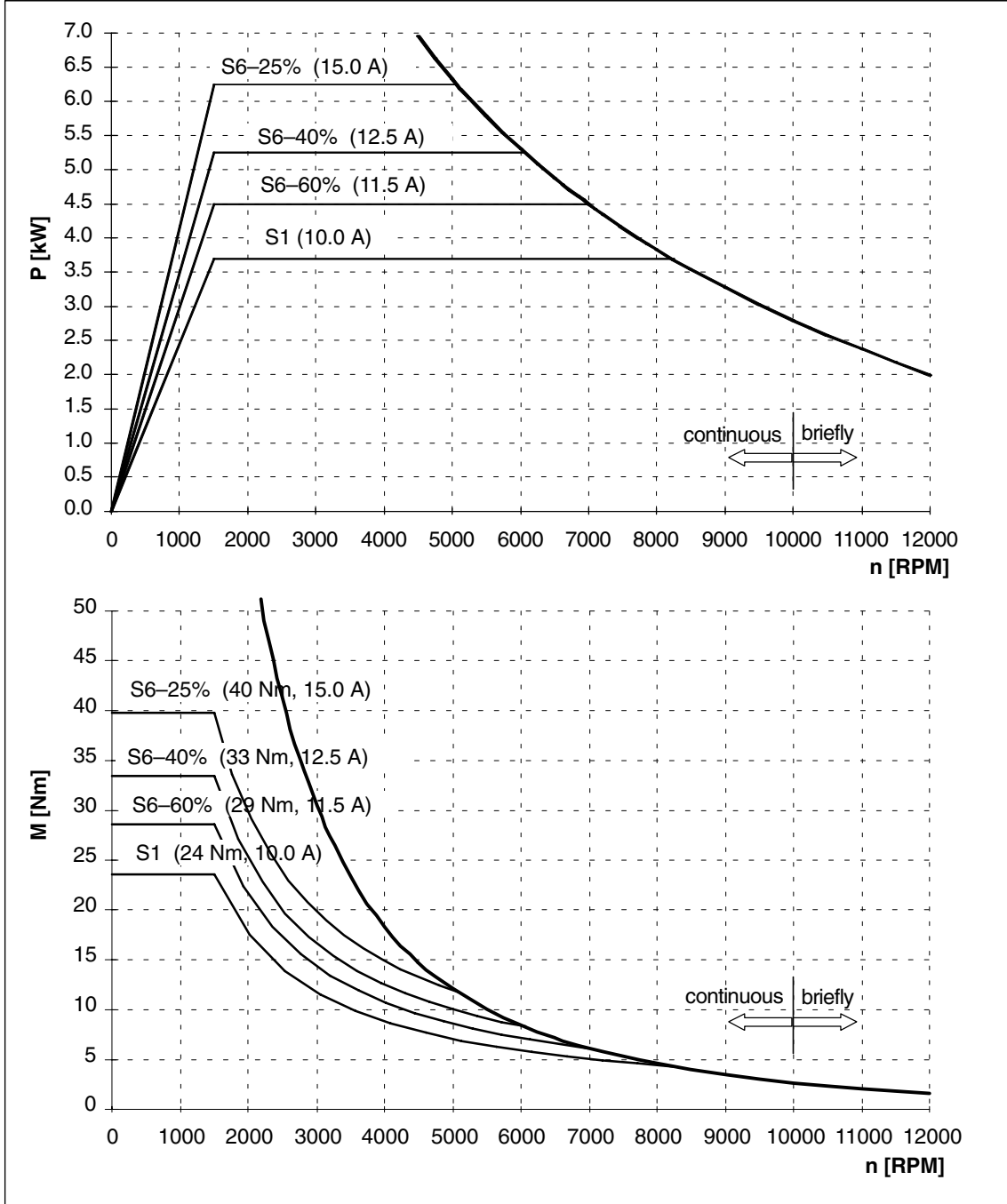

Fig. 2-2 1PH7101-□NF□□-0L

Table 2-6 Induction motor 1PH7103-□ND

P_N [kW]	n_N [RPM]	M_N [Nm]	I_N [A]	n_{max} [RPM]	T_{th} [min]	J [kgm ²]	m [kg]
3.7	1000	35	10	9000	20	0.017	40

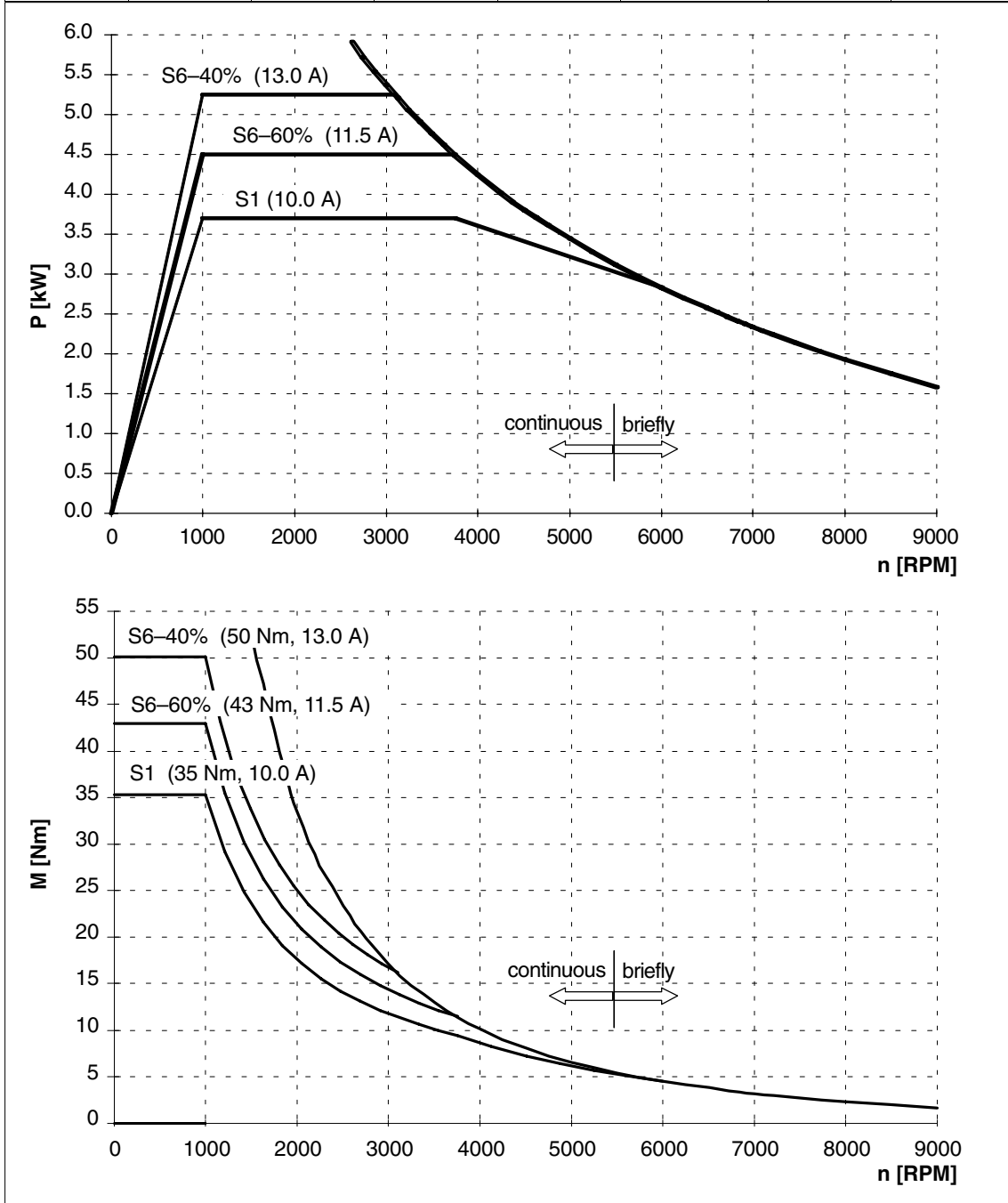

Fig. 2-3 1PH7103-□ND

2.2 Power-speed and torque-speed diagrams

Table 2-7 Induction motor 1PH7103-□ND□□-0L

P_N [kW]	n_N [RPM]	M_N [Nm]	I_N [A]	n_{max} [RPM]	T_{th} [min]	J [kgm ²]	m [kg]
3.7	1000	35	10	12000	20	0.017	40

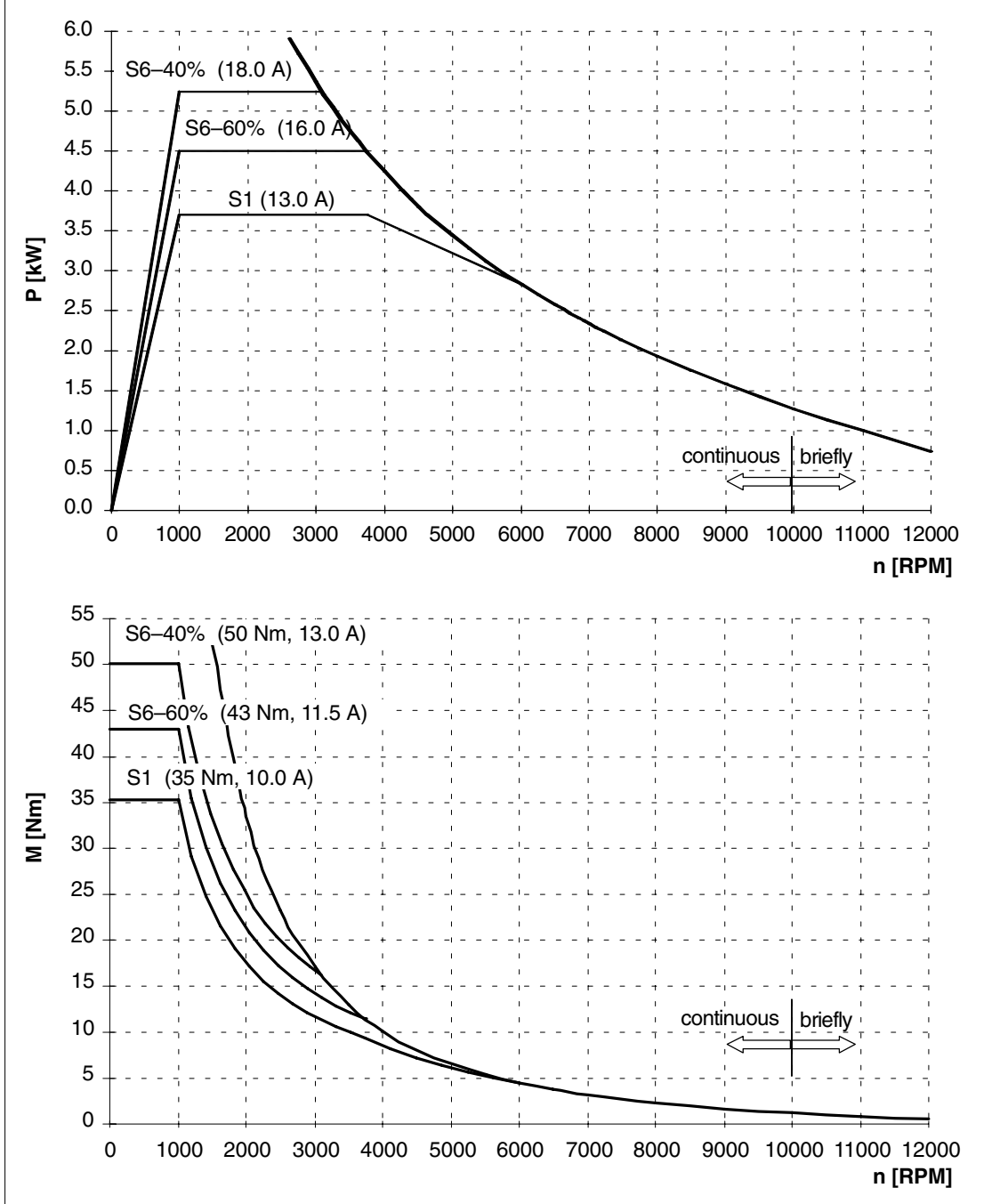

Fig. 2-4 1PH7103-□ND□□-0L

Table 2-8 Induction motor 1PH7103-□NF

P_N [kW]	n_N [RPM]	M_N [Nm]	I_N [A]	n_{max} [RPM]	T_{th} [min]	J [kgm ²]	m [kg]
5.5	1500	35	13	9000	20	0.017	40

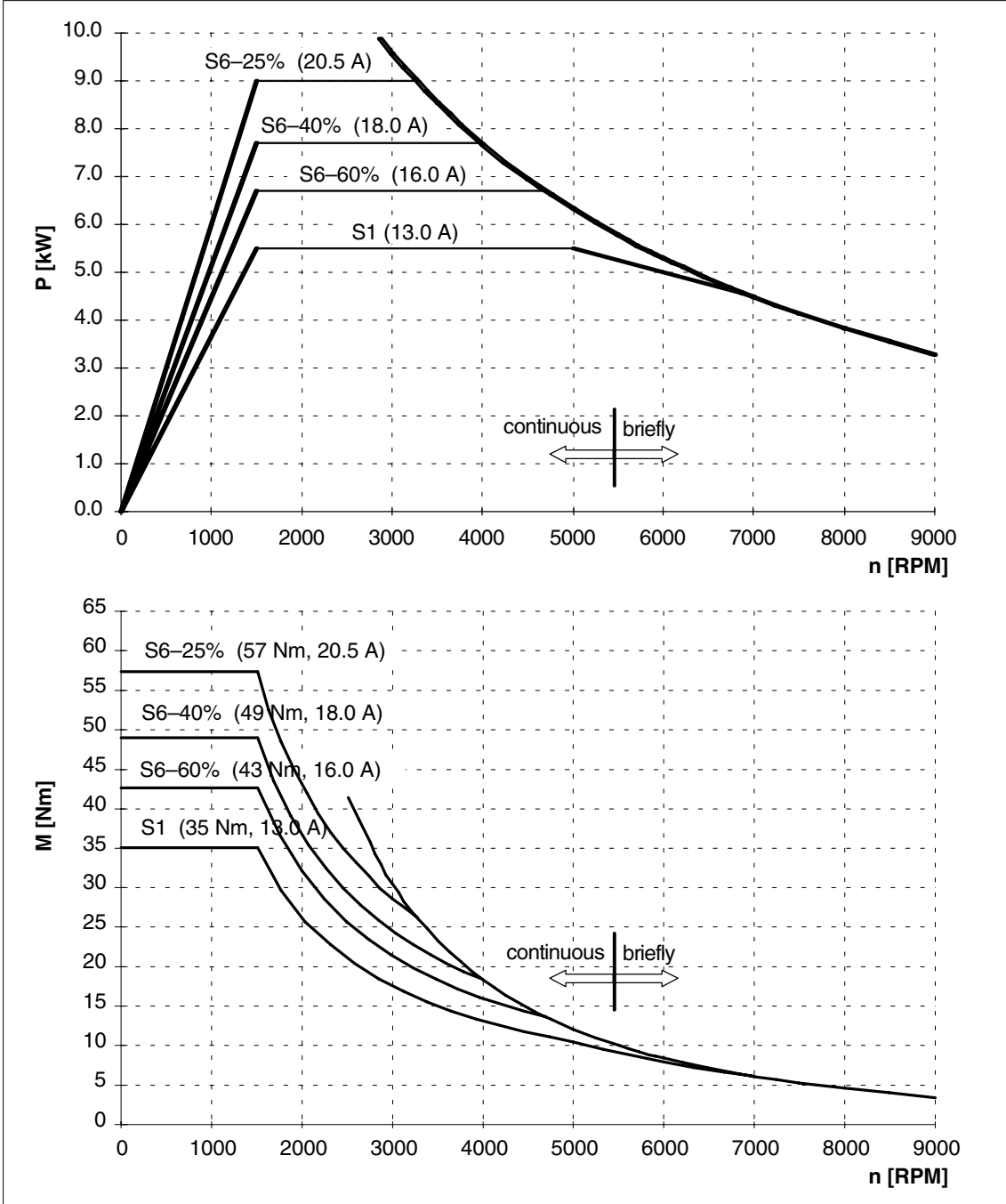

Fig. 2-5 1PH7103-□NF

2.2 Power-speed and torque-speed diagrams

Table 2-9 Induction motor 1PH7103-□NF□□-0L

P_N [kW]	n_N [RPM]	M_N [Nm]	I_N [A]	n_{max} [RPM]	T_{th} [min]	J [kgm ²]	m [kg]
5.5	1500	35	13	12000	20	0.017	40

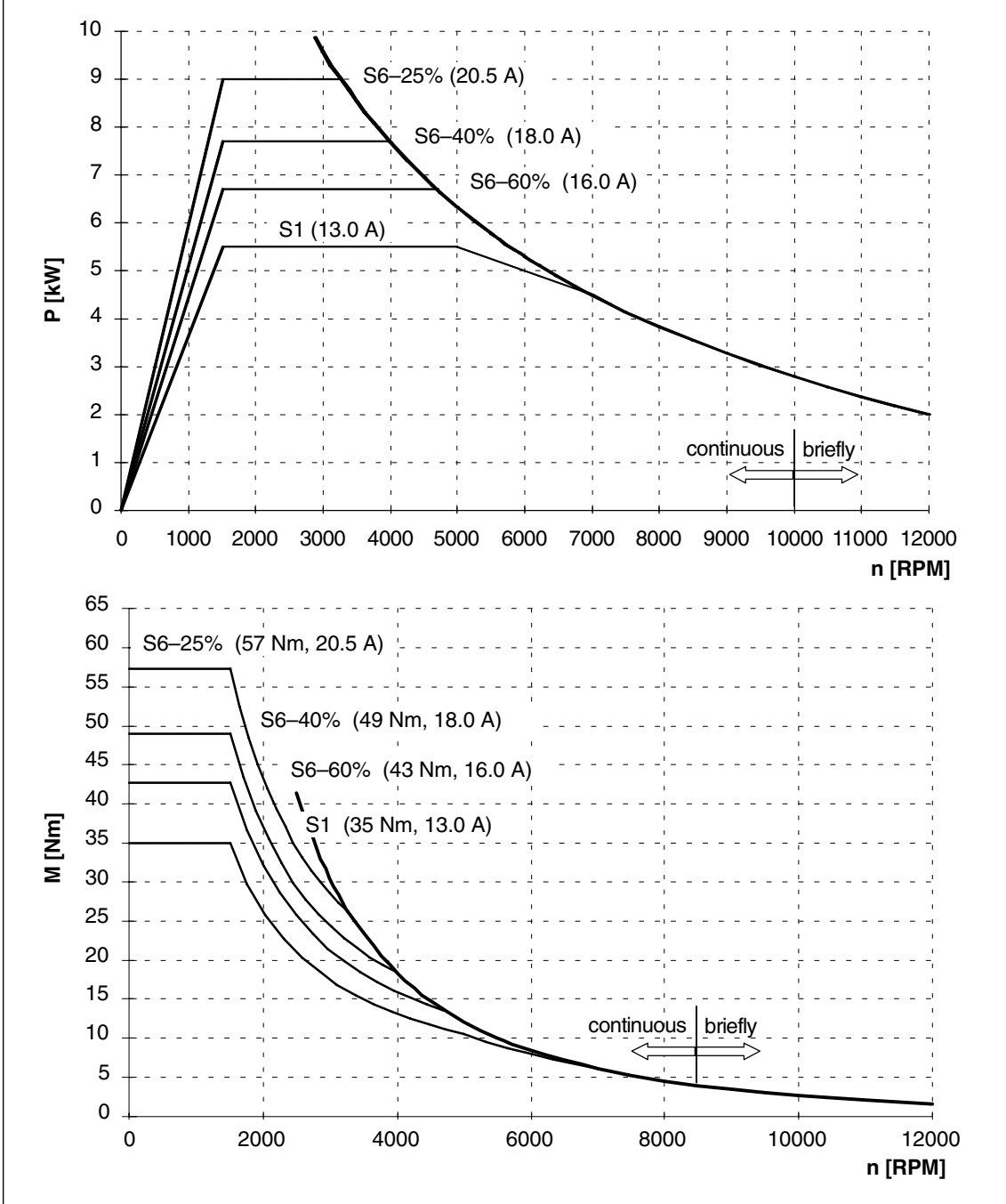

Fig. 2-6 1PH7103-□NF□□-0L

Table 2-10 Induction motor 1PH7103-□NG□□

P_N [kW]	n_N [RPM]	M_N [Nm]	I_N [A]	n_{max} [RPM]	T_{th} [min]	J [kgm ²]	m [kg]
7	2000	33	17.5	9000	20	0.017	40

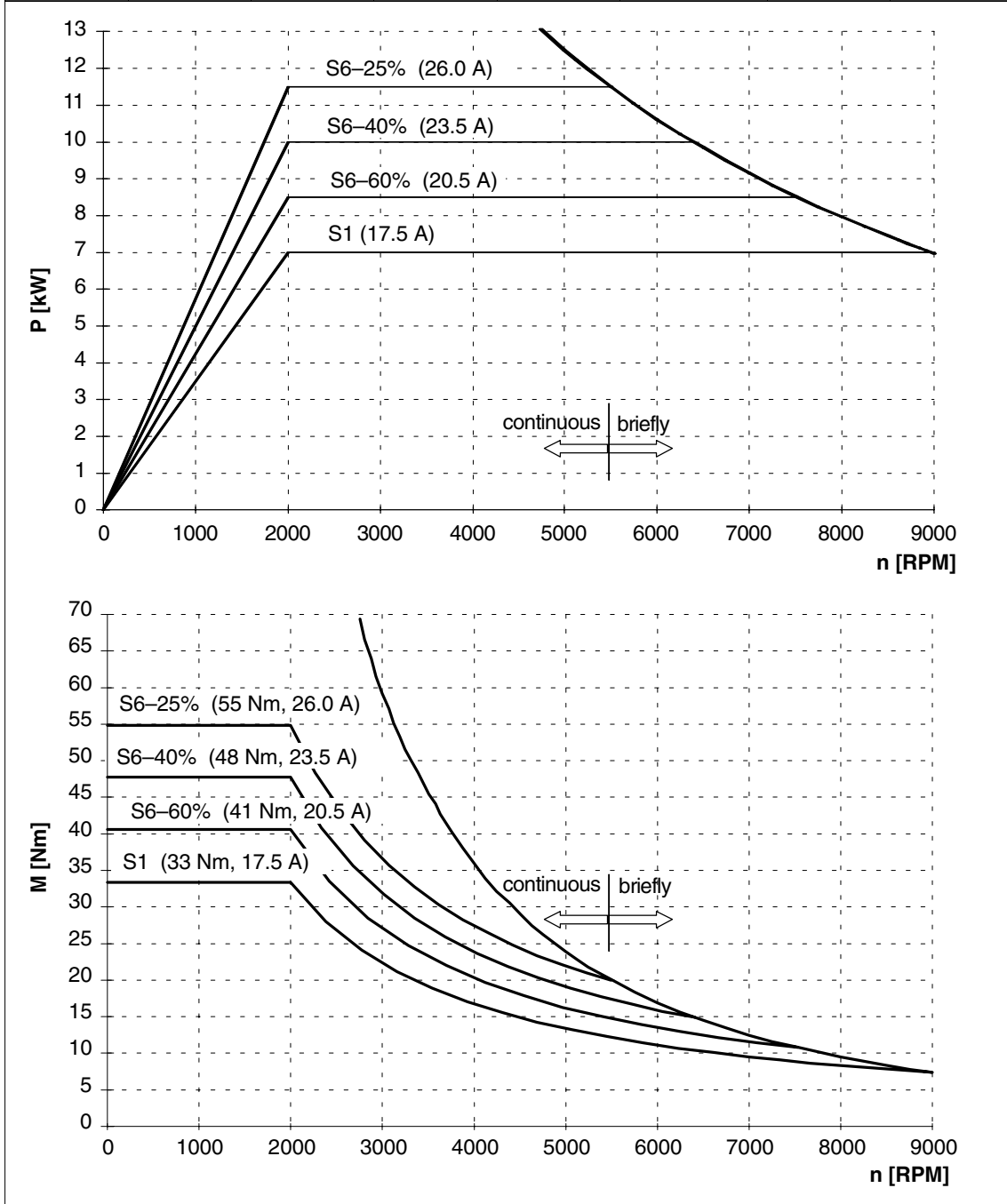

Fig. 2-7 1PH7103-□NG□□

2.2 Power-speed and torque-speed diagrams

Table 2-11 Induction motor 1PH7103-□NG□□-0L

P_N [kW]	n_N [RPM]	M_N [Nm]	I_N [A]	n_{max} [RPM]	T_{th} [min]	J [kgm ²]	m [kg]
7	2000	33	17.5	12000	20	0.017	40

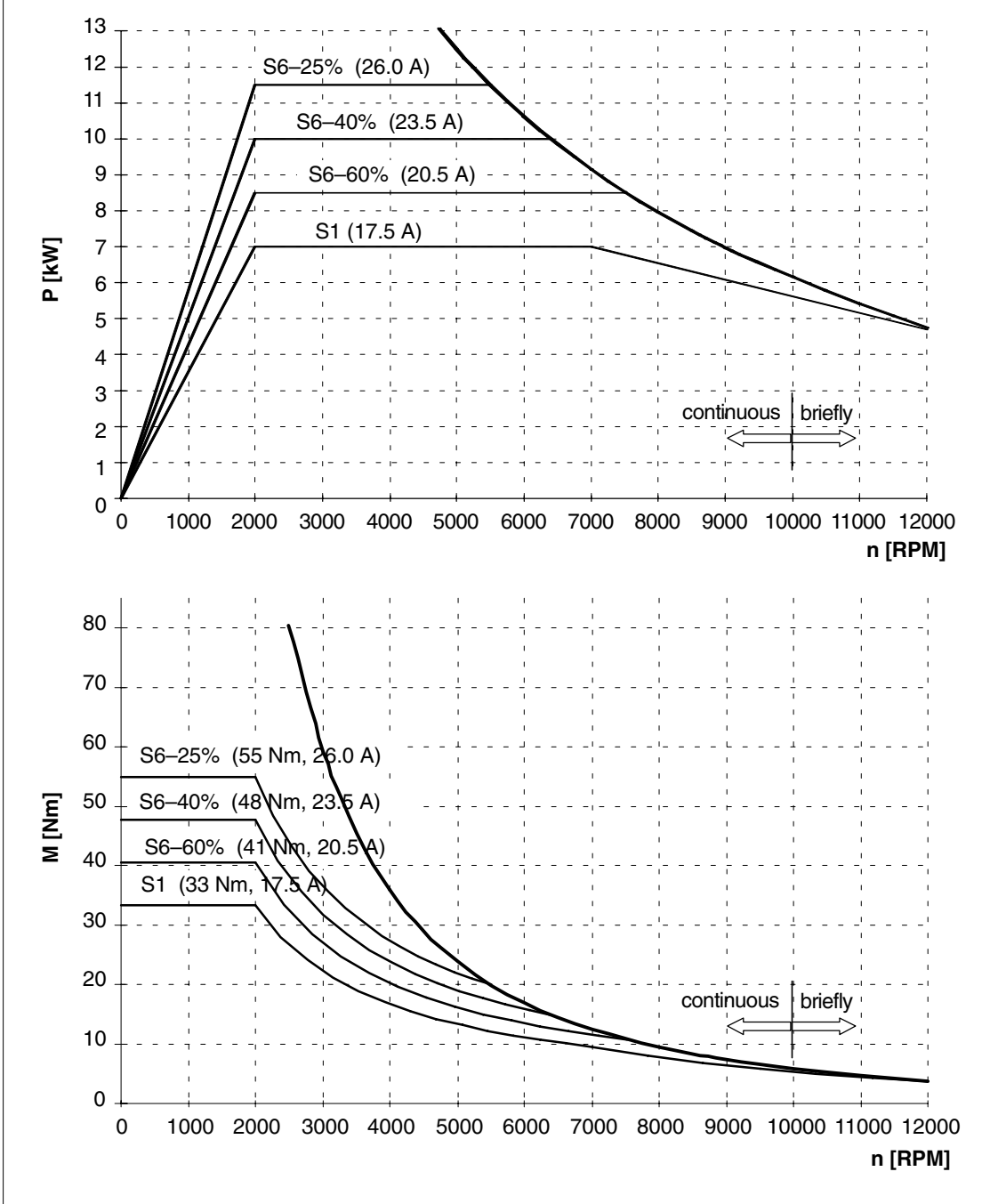

Fig. 2-8 1PH7103-□NG□□-0L

Table 2-12 Induction motor 1PH7105-□NF□□

P_N [kW]	n_N [RPM]	M_N [Nm]	I_N [A]	n_{max} [RPM]	T_{th} [min]	J [kgm ²]	m [kg]
7.0	1500	45	17.5	9000	20	0.029	63

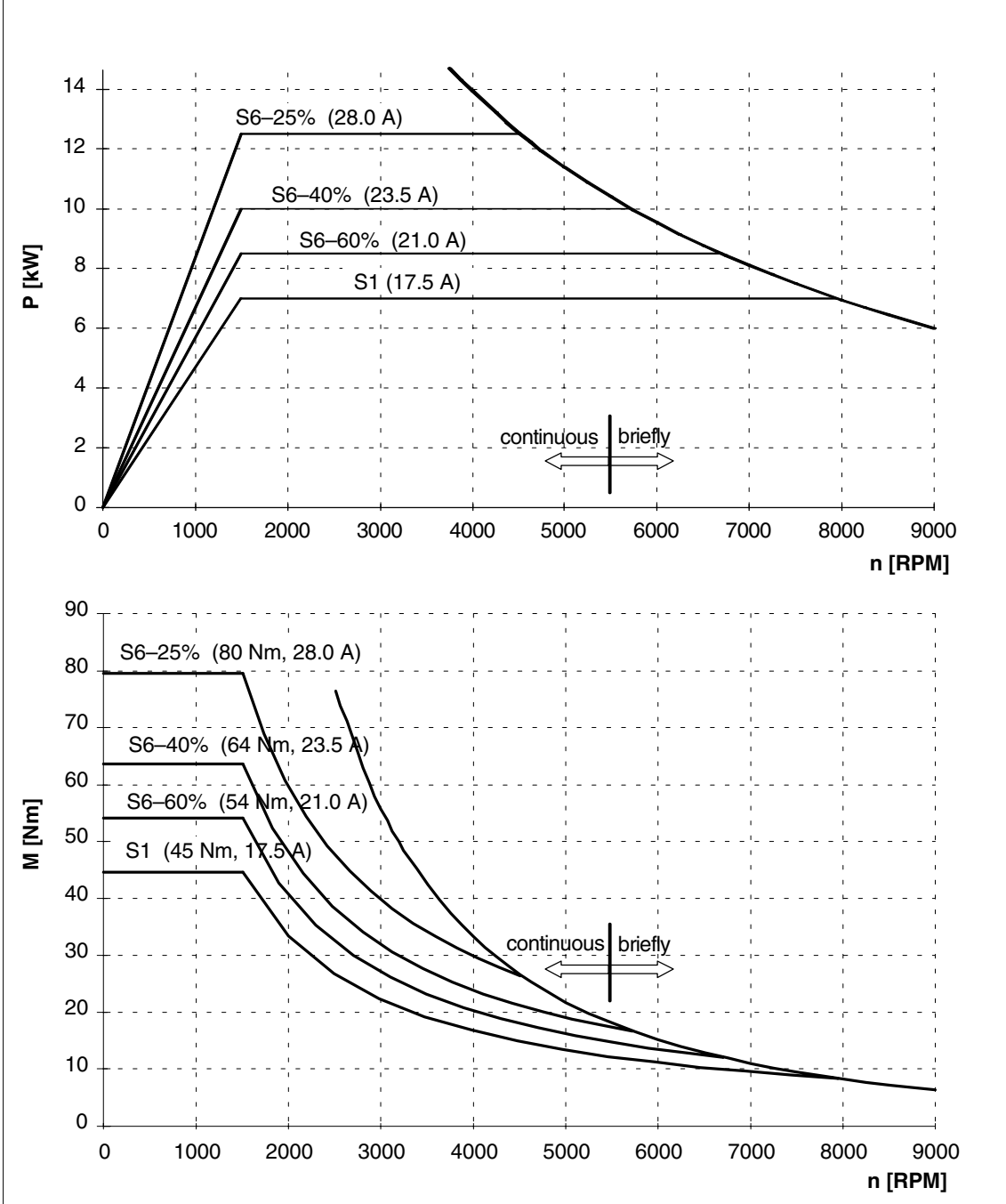

Fig. 2-9 1PH7105-□NF□□

2.2 Power-speed and torque-speed diagrams

Table 2-13 Induction motor 1PH7105-□NF□□-0L

P_N [kW]	n_N [RPM]	M_N [Nm]	I_N [A]	n_{max} [RPM]	T_{th} [min]	J [kgm ²]	m [kg]
7.0	1500	45	17.5	12000	20	0.029	63

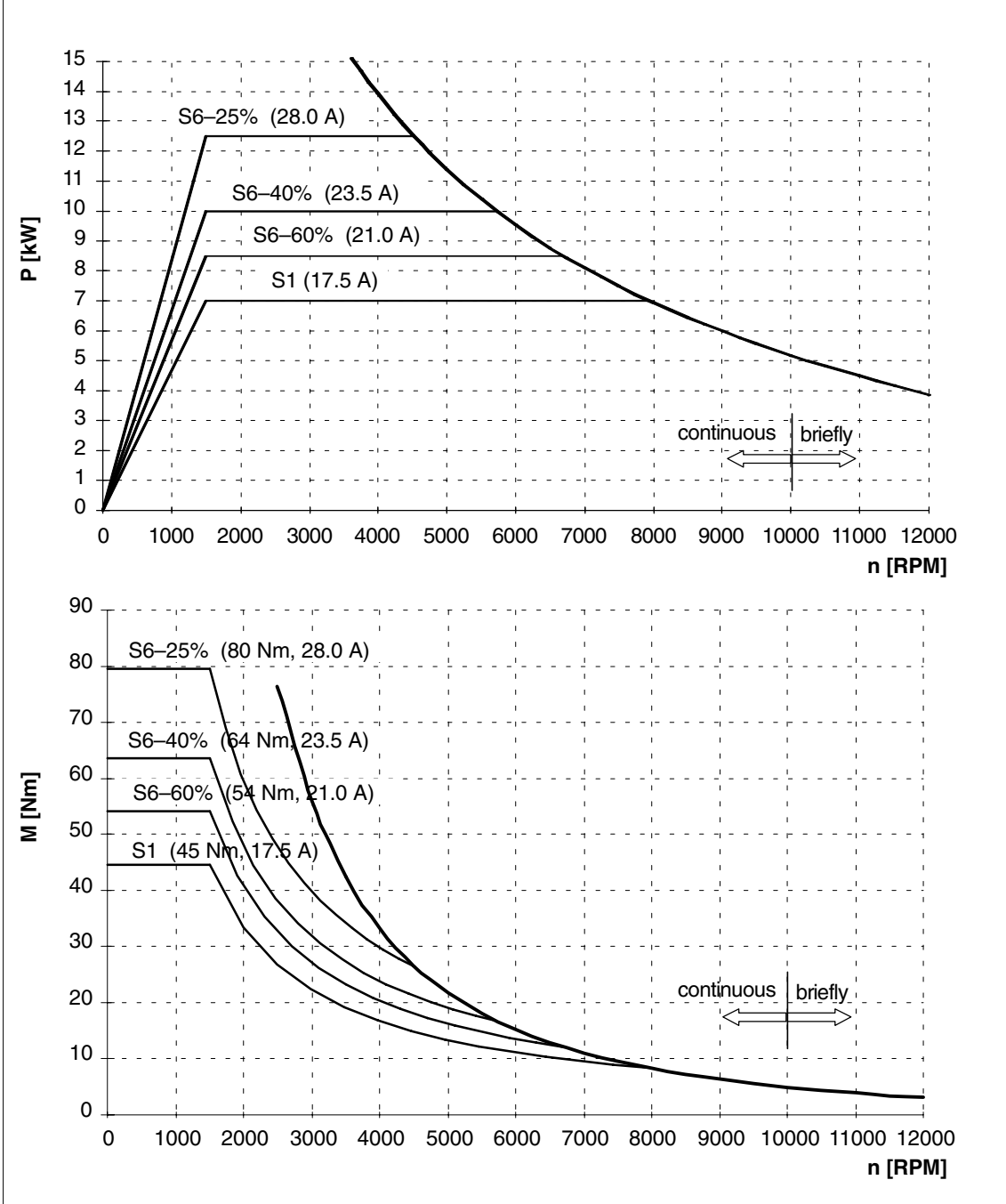

Fig. 2-10 1PH7105-□NF□□-0L

Table 2-14 Induction motor 1PH7107-□ND

P_N [kW]	n_N [RPM]	M_N [Nm]	I_N [A]	n_{max} [RPM]	T_{th} [min]	J [kgm ²]	m [kg]
6.25	1000	60	17.5	9000	20	0.029	63

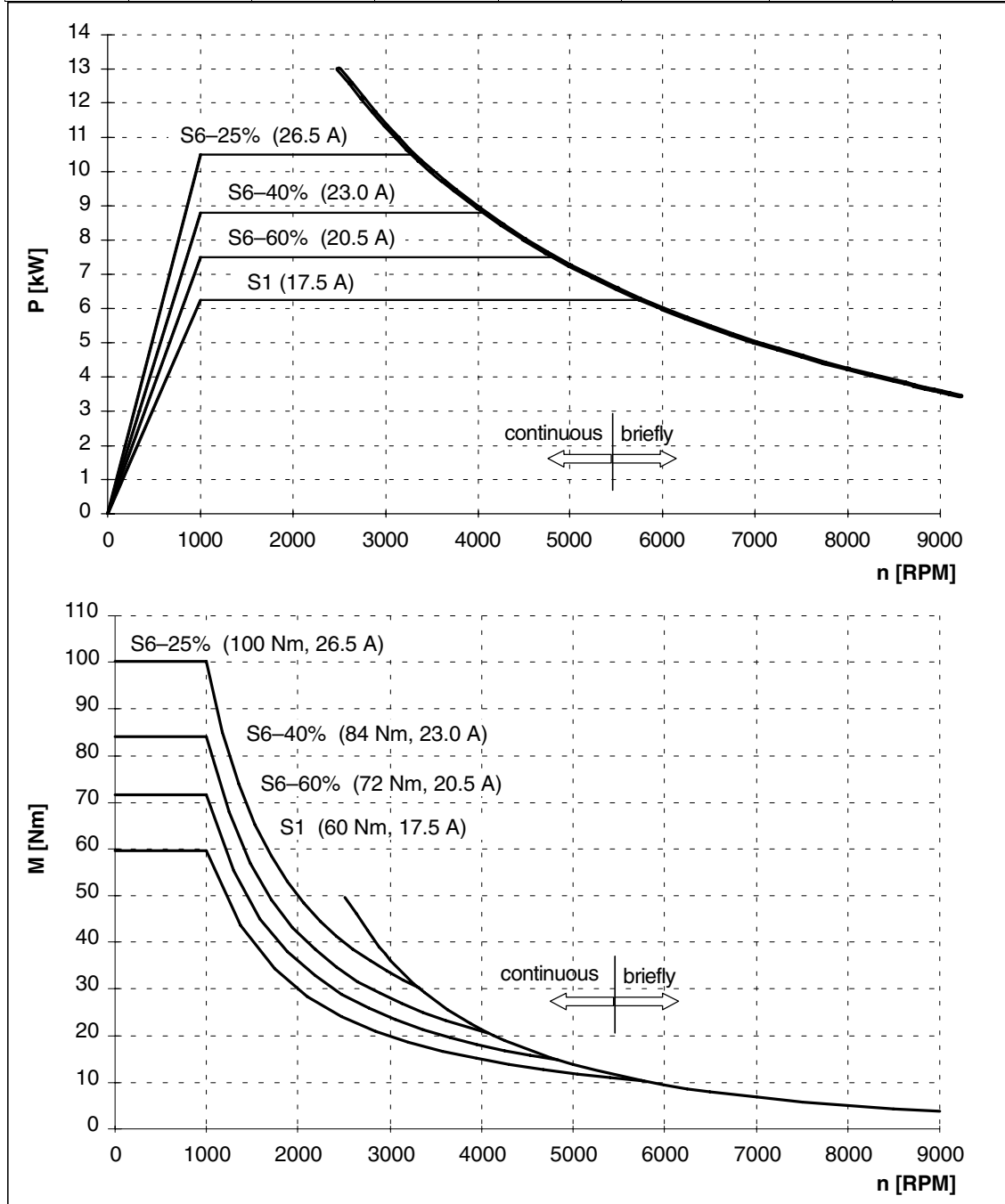

Fig. 2-11 1PH7107-□ND

2.2 Power-speed and torque-speed diagrams

Table 2-15 Induction motor 1PH7107-□ND□□-0L

P_N [kW]	n_N [RPM]	M_N [Nm]	I_N [A]	n_{max} [RPM]	T_{th} [min]	J [kgm ²]	m [kg]
6.25	1000	60	17.5	12000	20	0.029	63

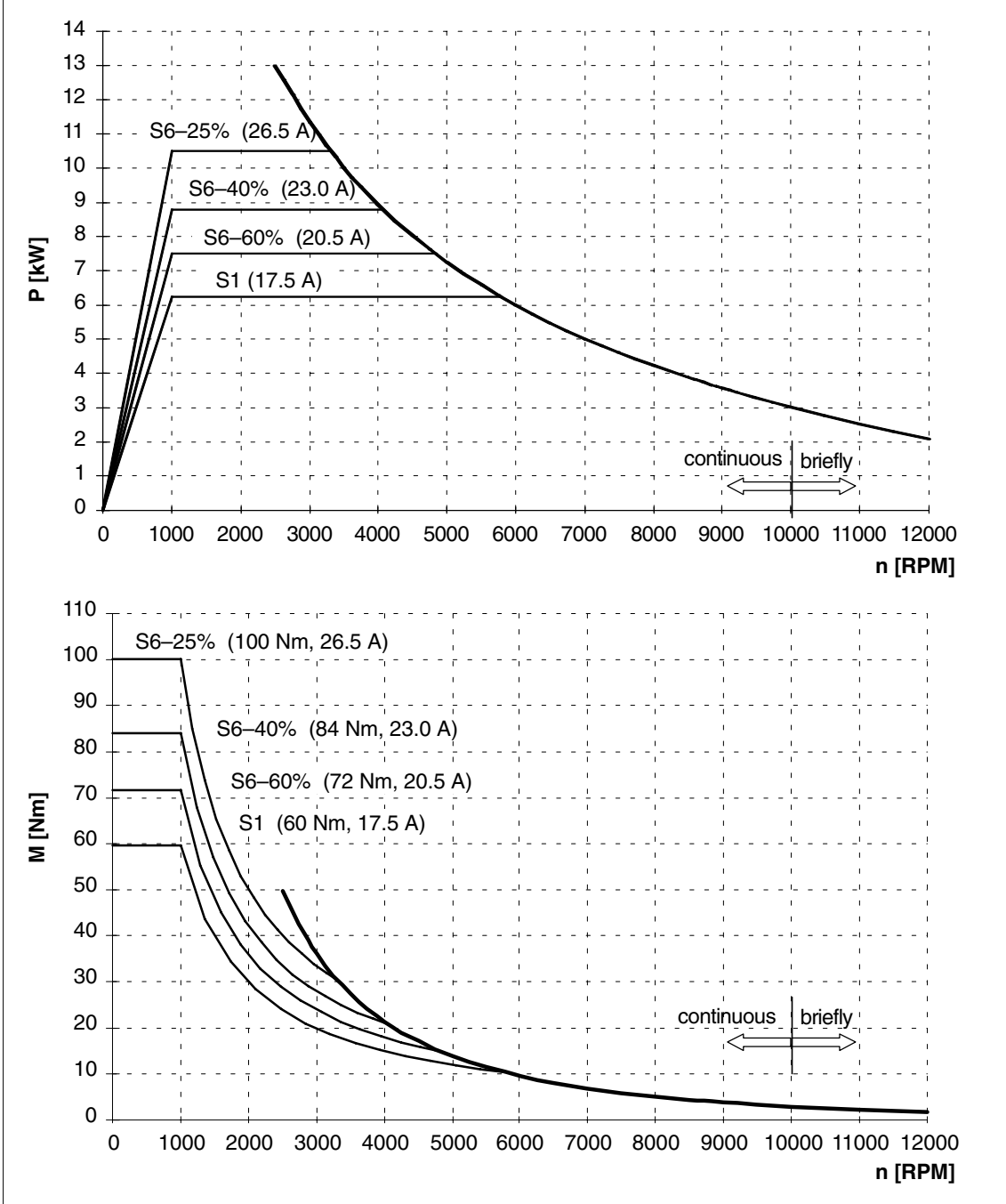

Fig. 2-12 1PH7107-□ND□□-0L

Table 2-16 Induction motor 1PH7107-□NF□□

P_N [kW]	n_N [RPM]	M_N [Nm]	I_N [A]	n_{max} [RPM]	T_{th} [min]	J [kgm ²]	m [kg]
9.0	1500	57	23.5	9000	20	0.029	63

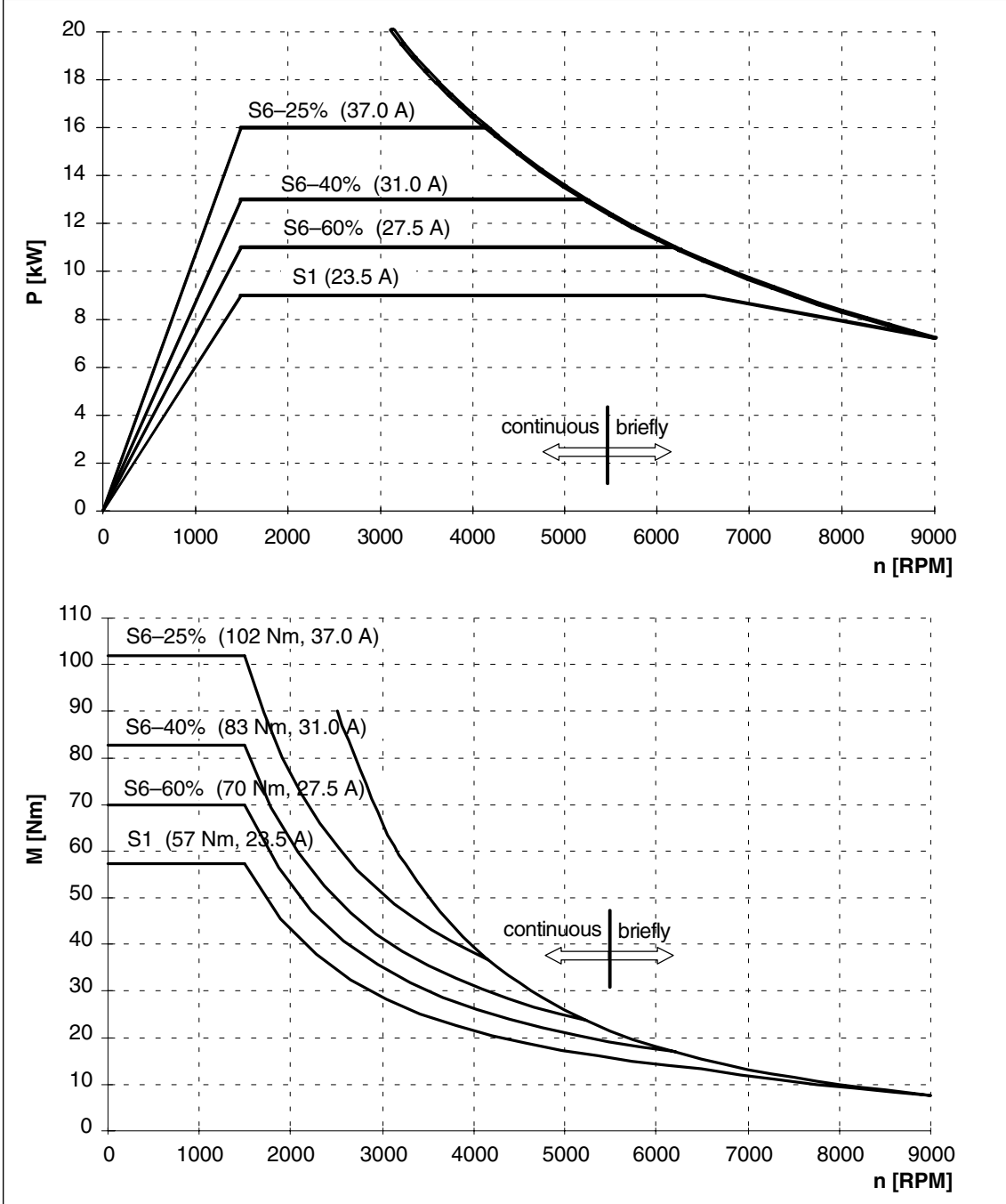

Fig. 2-13 1PH7107-□NF□□

2.2 Power-speed and torque-speed diagrams

Table 2-17 Induction motor 1PH7107-□NF□□-0L

P_N [kW]	n_N [RPM]	M_N [Nm]	I_N [A]	n_{max} [RPM]	T_{th} [min]	J [kgm ²]	m [kg]
9.0	1500	57	23.5	12000	20	0.029	63

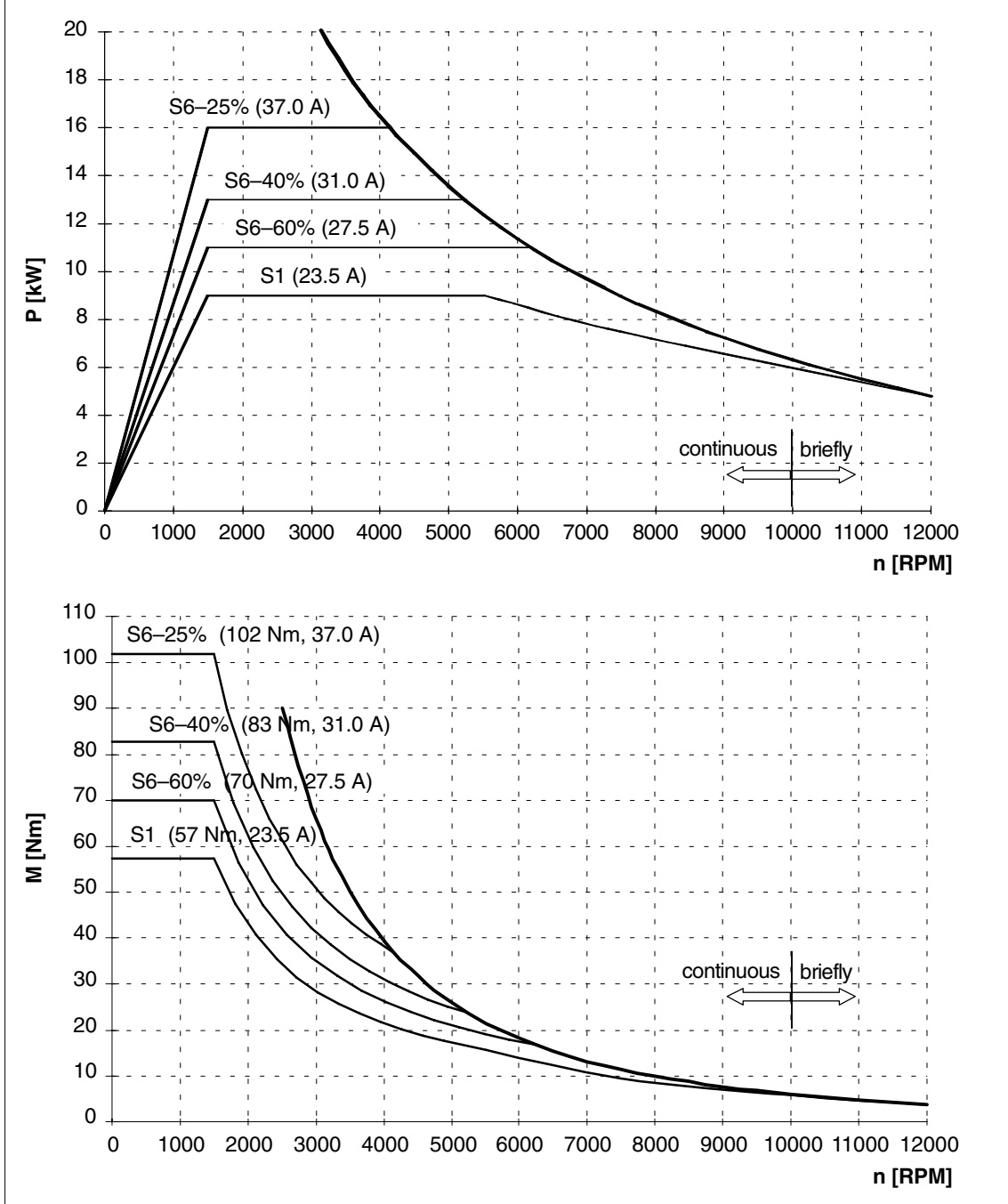

Fig. 2-14 1PH7107-□NF□□-0L

Table 2-18 Induction motor 1PH7107-□NG

P_N [kW]	n_N [RPM]	M_N [Nm]	I_N [A]	n_{max} [RPM]	T_{th} [min]	J [kgm ²]	m [kg]
10.5	2000	50	26	9000	20	0.029	63

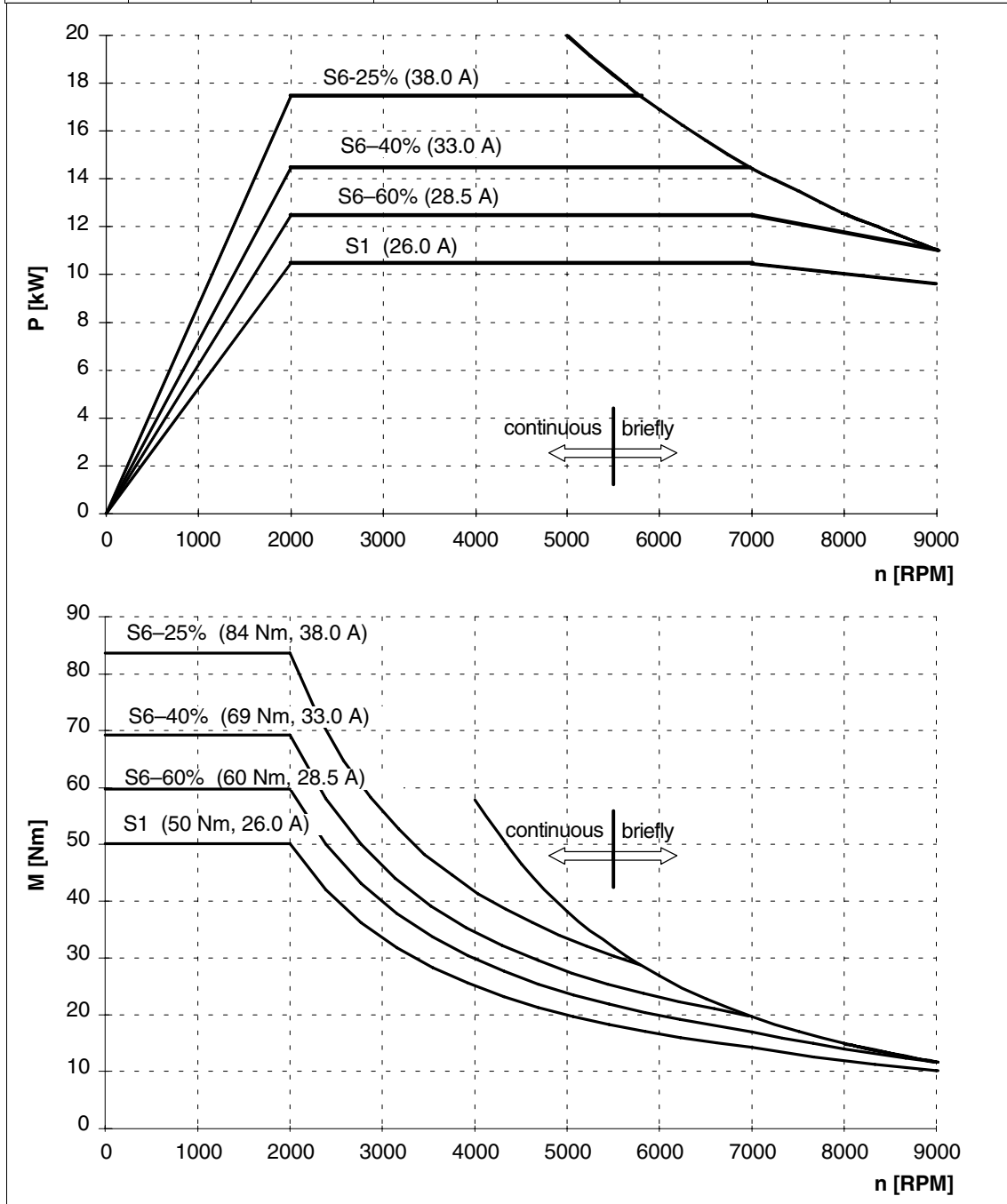

Fig. 2-15 1PH7107-□NG

2.2 Power-speed and torque-speed diagrams

Table 2-19 Induction motor 1PH7107-□NG□□-0L

P_N [kW]	n_N [RPM]	M_N [Nm]	I_N [A]	n_{max} [RPM]	T_{th} [min]	J [kgm ²]	m [kg]
10.5	2000	50	26	12000	20	0.029	63

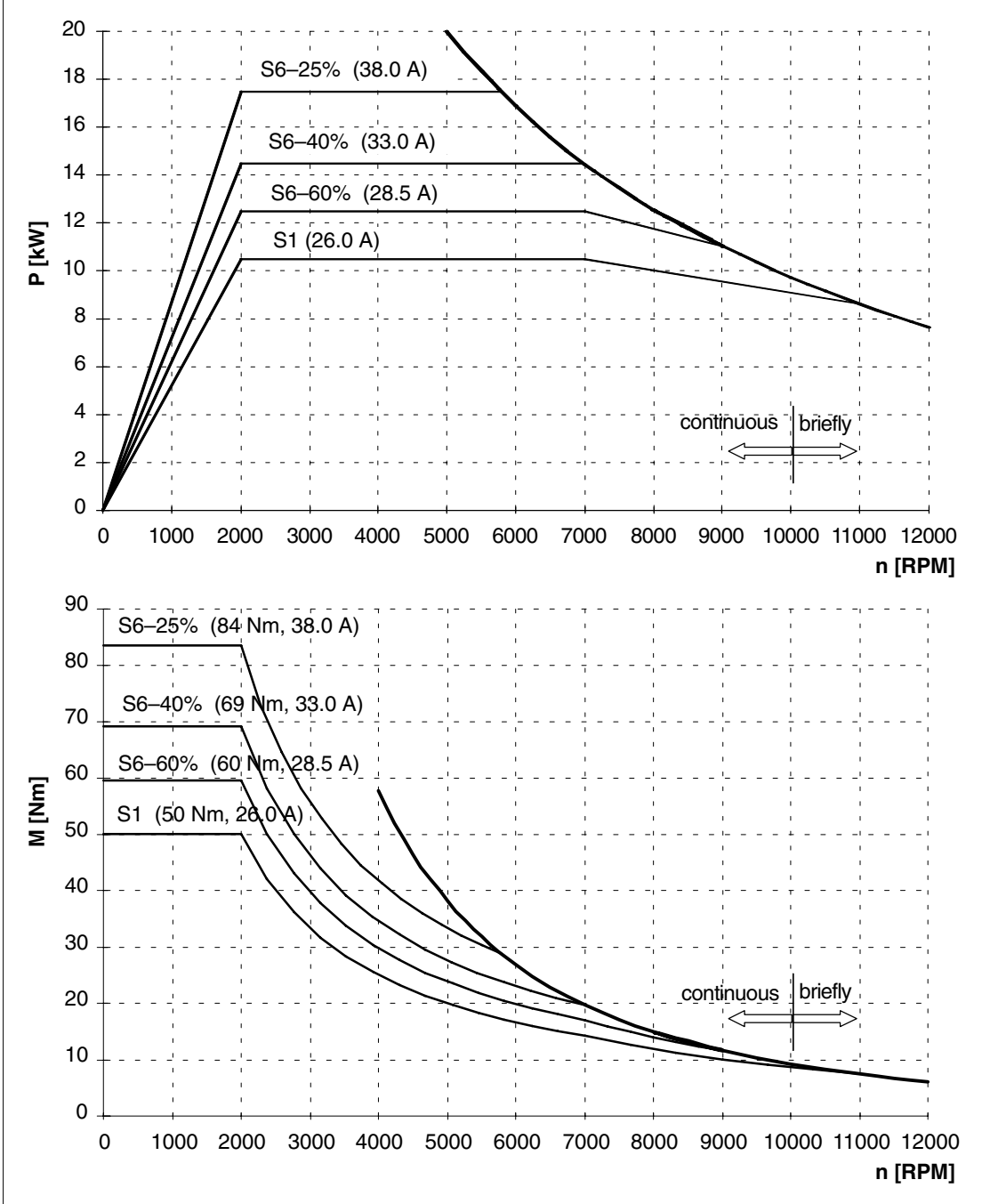

Fig. 2-16 1PH7107-□NG□□-0L

Table 2-20 Induction motor 1PH7131-□NF□□

P_N [kW]	n_N [RPM]	M_N [Nm]	I_N [A]	n_{max} [RPM]	T_{th} [min]	J [kgm ²]	m [kg]
11	1500	70	24	8000	30	0.076	90

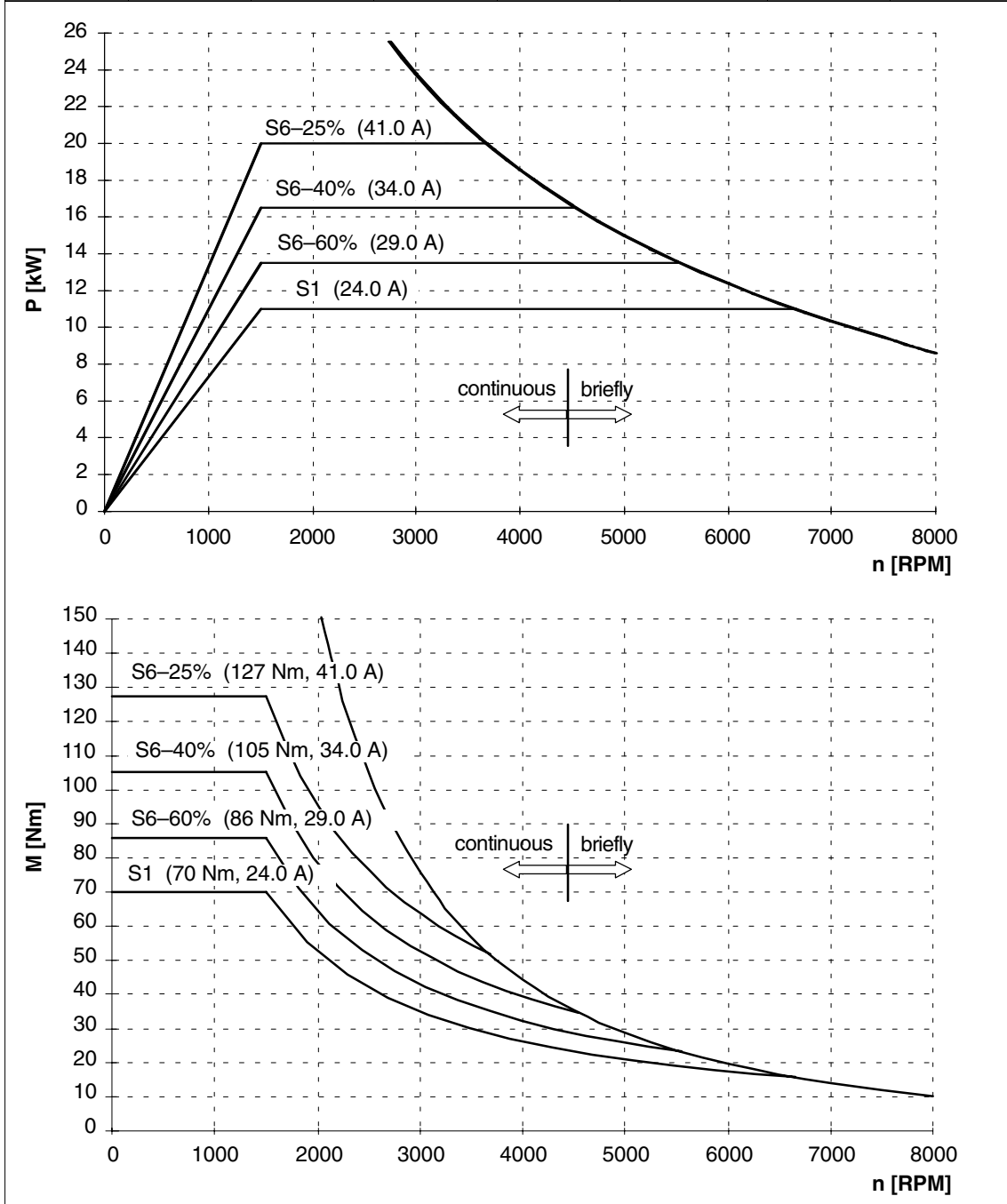

Fig. 2-17 1PH7131-□NF□□

2.2 Power-speed and torque-speed diagrams

Table 2-21 Induction motor 1PH7131-□NF□□-0L

P_N [kW]	n_N [RPM]	M_N [Nm]	I_N [A]	n_{max} [RPM]	T_{th} [min]	J [kgm ²]	m [kg]
11	1500	70	24	10000	30	0.076	90

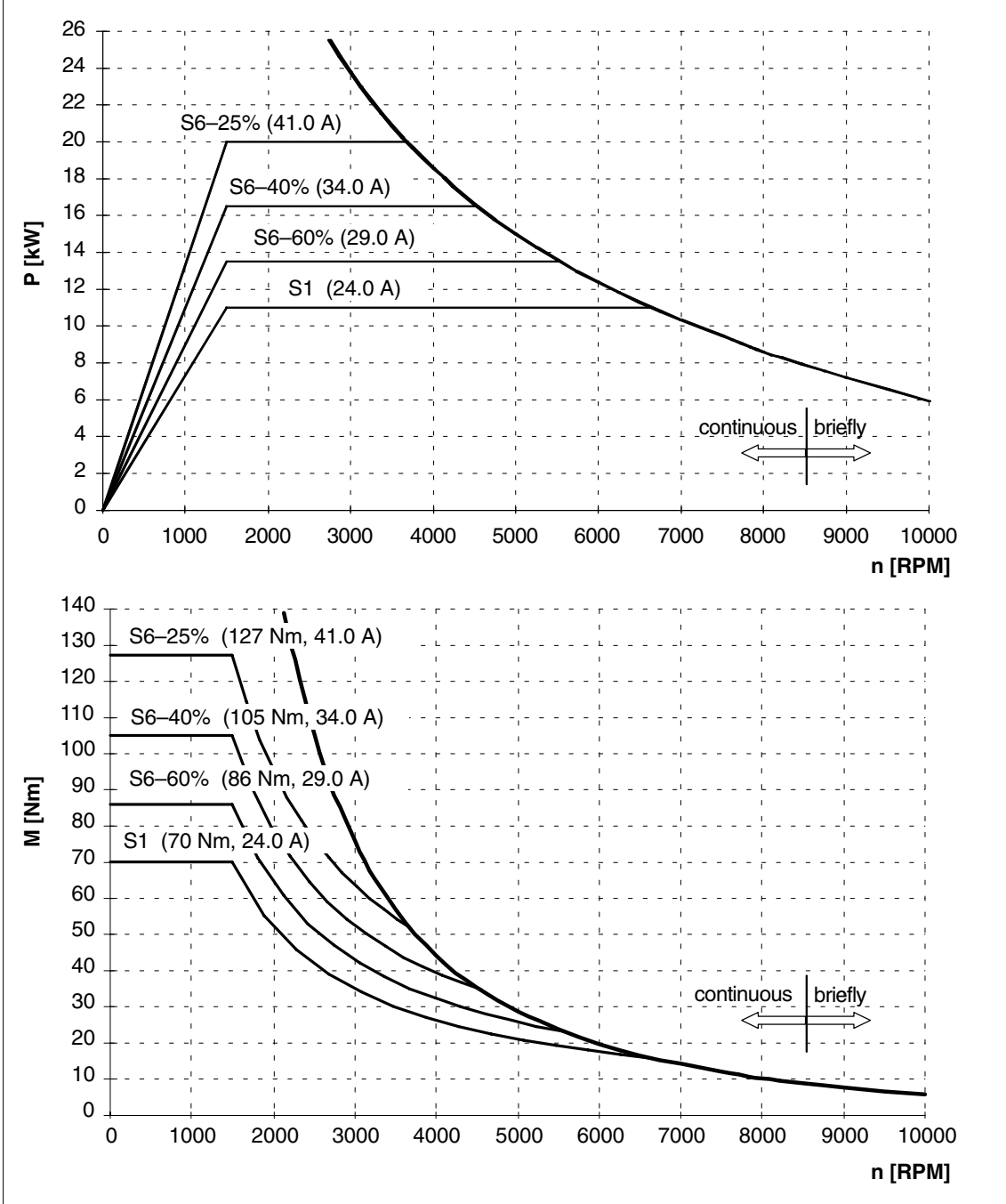

Fig. 2-18 1PH7131-□NF□□-0L

Table 2-22 Induction motor 1PH7133-□ND□□

P_N [kW]	n_N [RPM]	M_N [Nm]	I_N [A]	n_{max} [RPM]	T_{th} [min]	J [kgm ²]	m [kg]
12	1000	115	30	8000	30	0.076	90

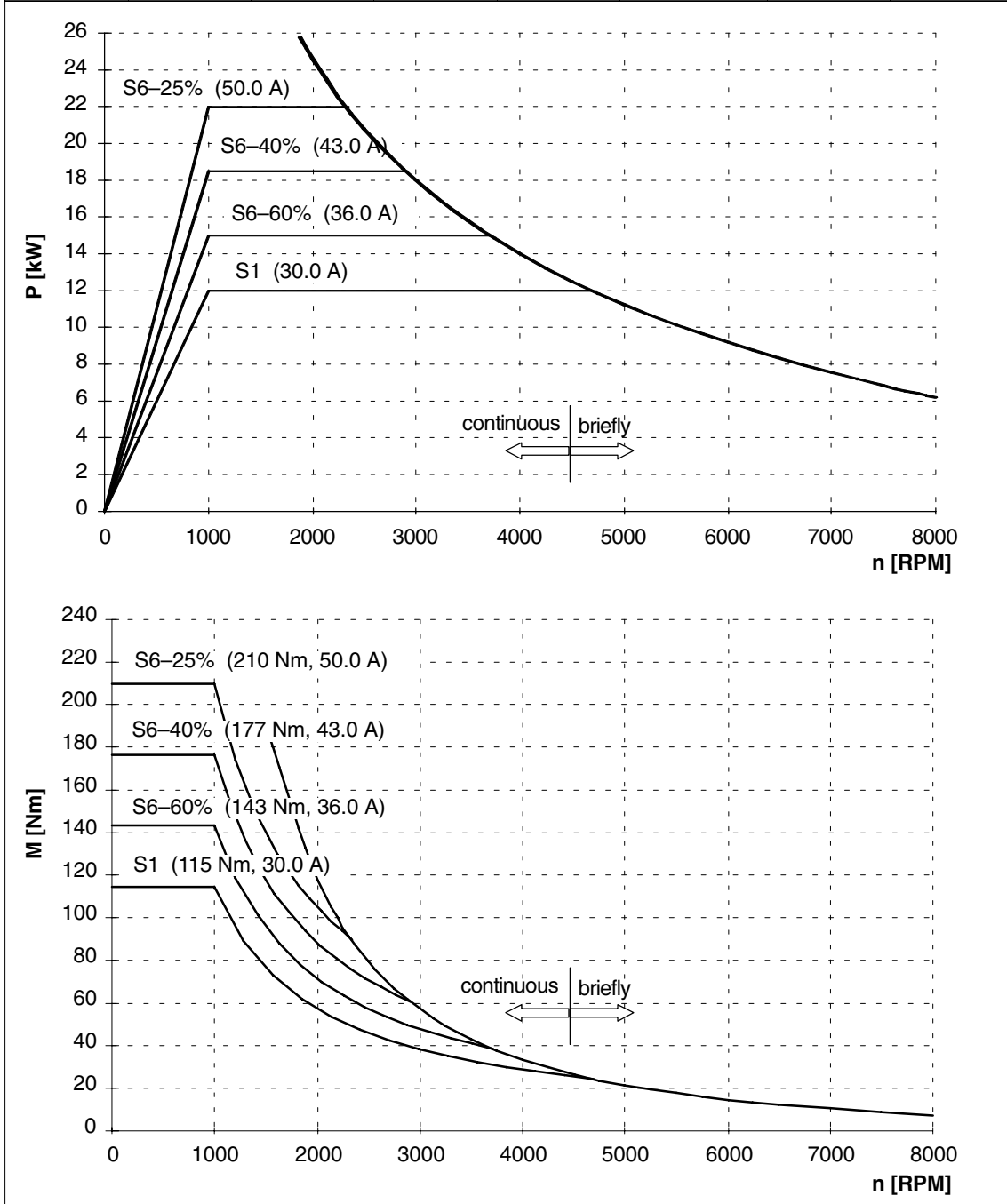

Fig. 2-19 1PH7133-□ND□□

2.2 Power-speed and torque-speed diagrams

Table 2-23 Induction motor 1PH7133-ND-OL

P_N [kW]	n_N [RPM]	M_N [Nm]	I_N [A]	n_{max} [RPM]	T_{th} [min]	J [kgm ²]	m [kg]
12	1000	115	30	10000	30	0.076	90

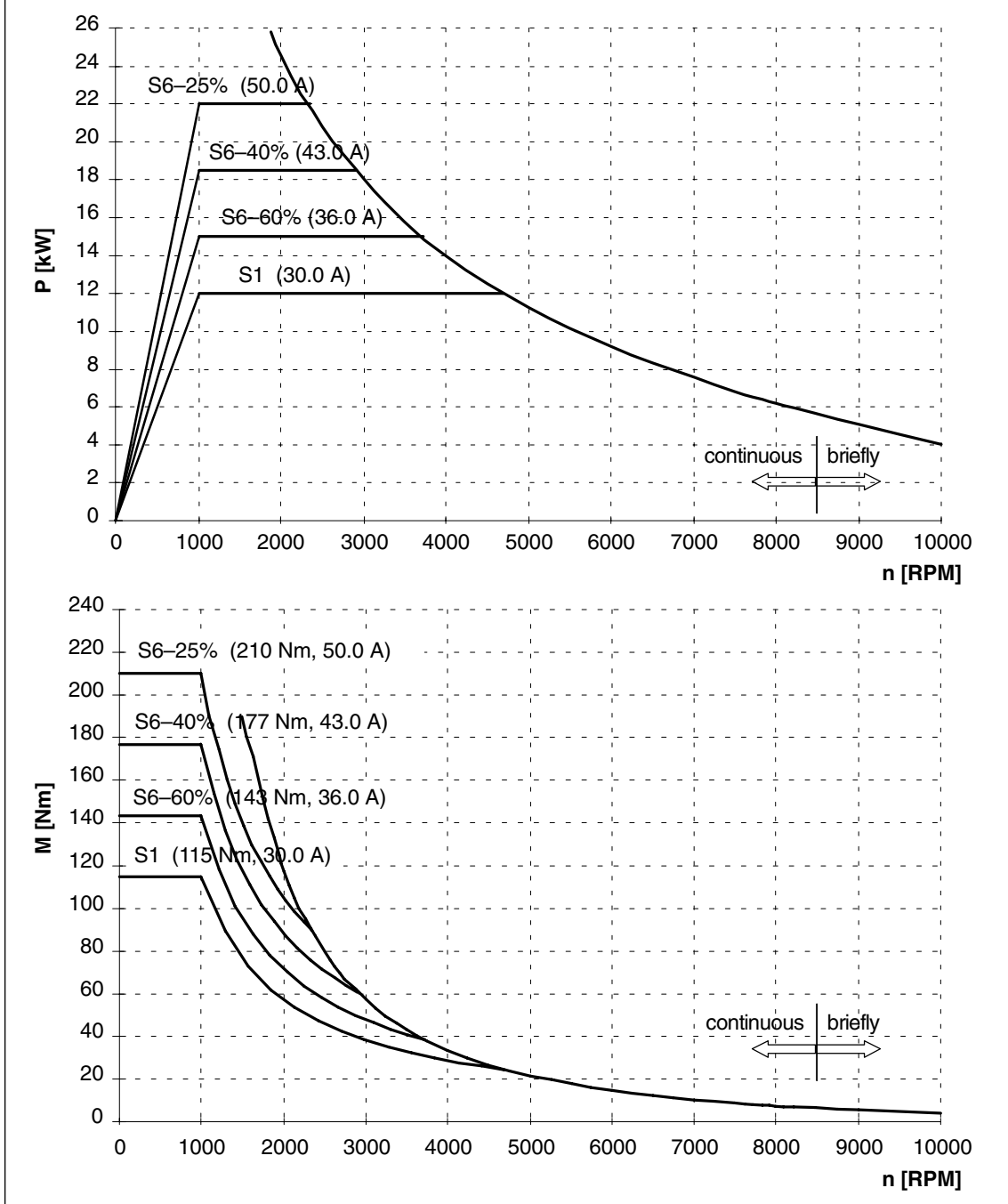

Fig. 2-20 1PH7133-ND-OL

Table 2-24 Induction motor 1PH7133-□NF

P_N [kW]	n_N [RPM]	M_N [Nm]	I_N [A]	n_{max} [RPM]	T_{th} [min]	J [kgm ²]	m [kg]
15	1500	95	34	8000	30	0.1076	90

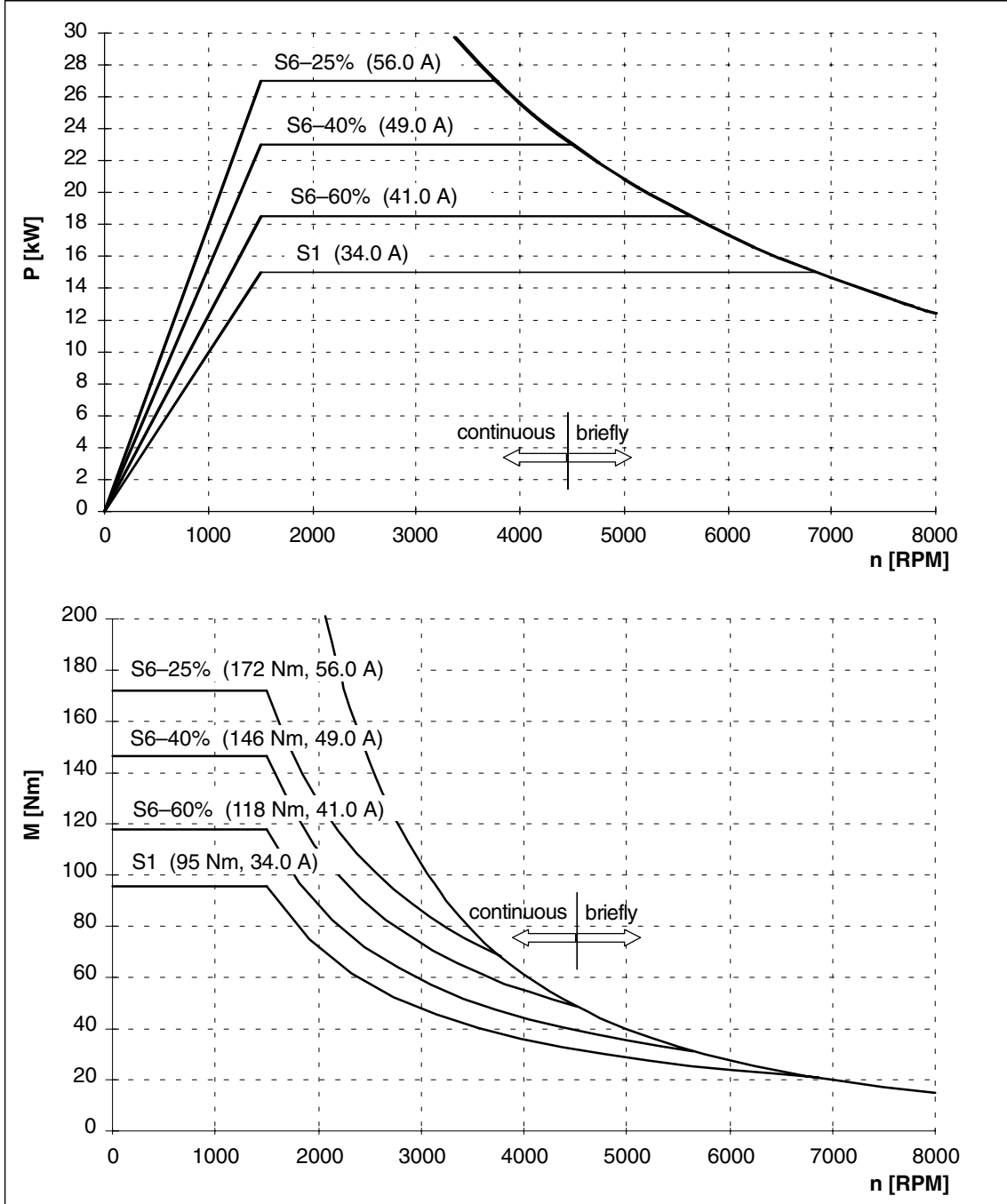

Fig. 2-21 1PH7133-□NF

2.2 Power-speed and torque-speed diagrams

Table 2-25 Induction motor 1PH7133-□NF□□-0L

P_N [kW]	n_N [RPM]	M_N [Nm]	I_N [A]	n_{max} [RPM]	T_{th} [min]	J [kgm ²]	m [kg]
15	1500	95	34	10000	30	0.076	90

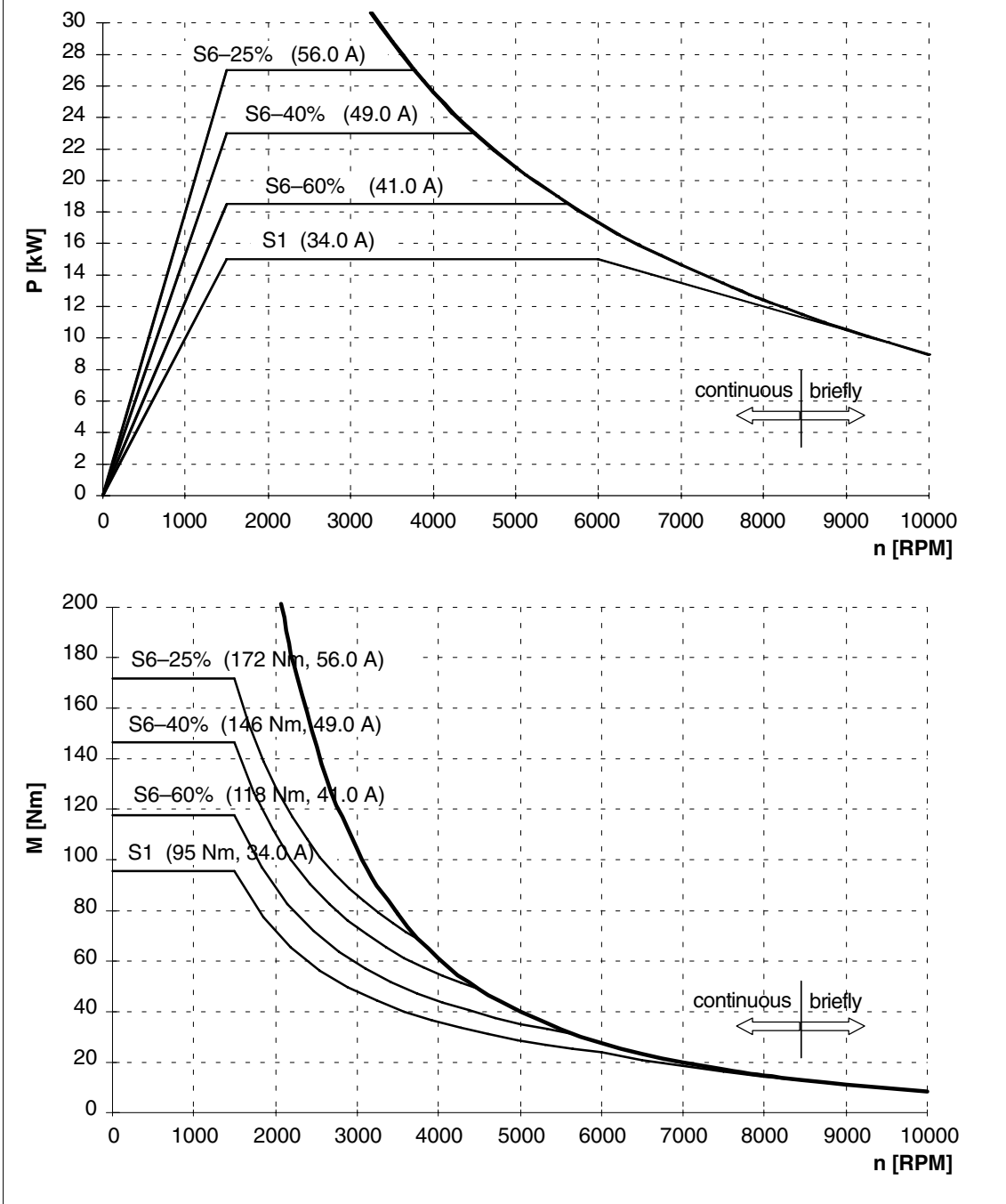

Fig. 2-22 1PH7133-□NF□□-0L

Table 2-26 Induction motor 1PH7133-□NG□□

P_N [kW]	n_N [RPM]	M_N [Nm]	I_N [A]	n_{max} [RPM]	T_{th} [min]	J [kgm ²]	m [kg]
20	2000	95	45	8000	30	0.076	90

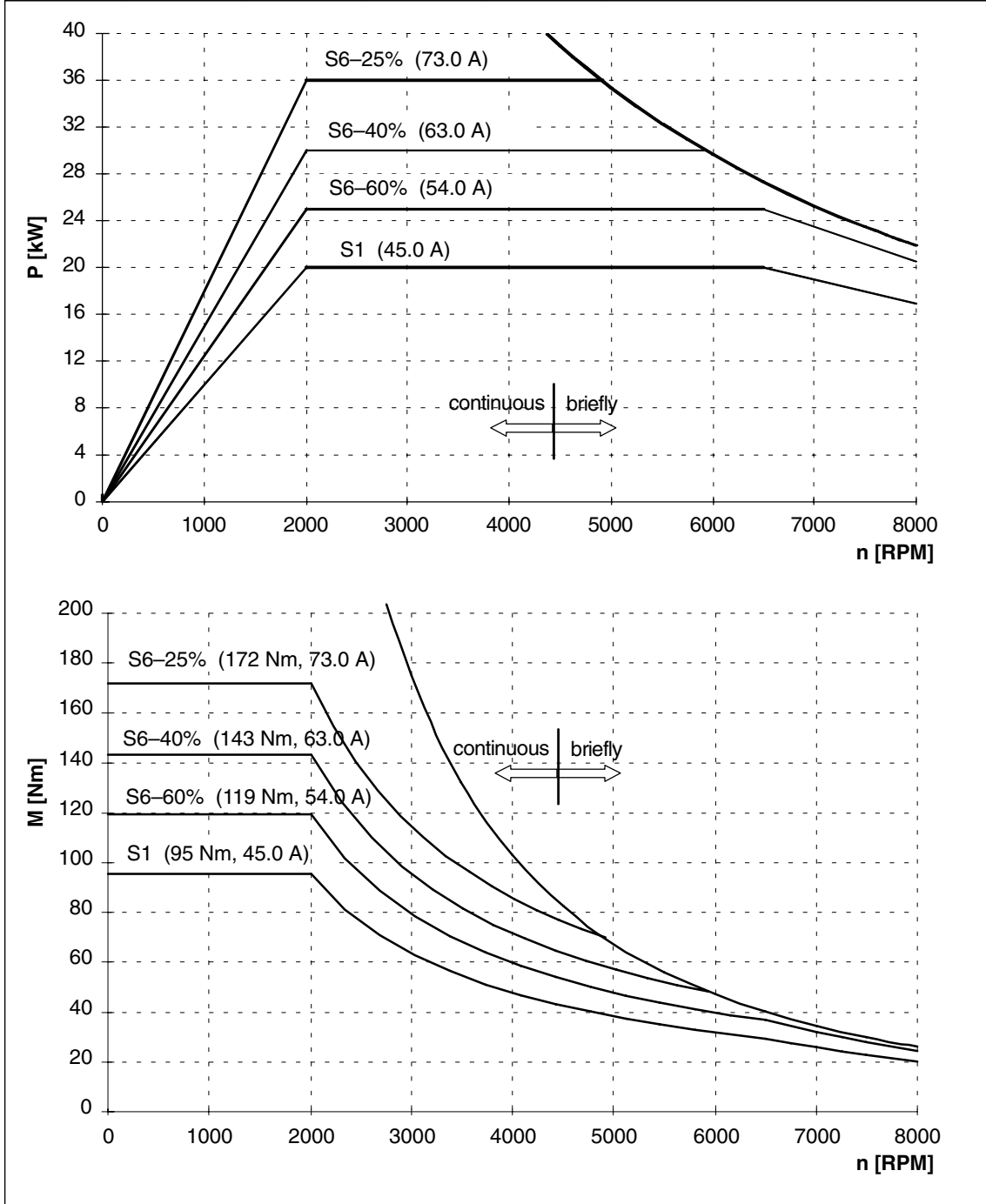

Fig. 2-23 1PH7133-□NG□□

2.2 Power-speed and torque-speed diagrams

Table 2-27 Induction motor 1PH7133-□NG□□-0L

P_N [kW]	n_N [RPM]	M_N [Nm]	I_N [A]	n_{max} [RPM]	T_{th} [min]	J [kgm ²]	m [kg]
20	2000	95	45	10000	30	0.076	90

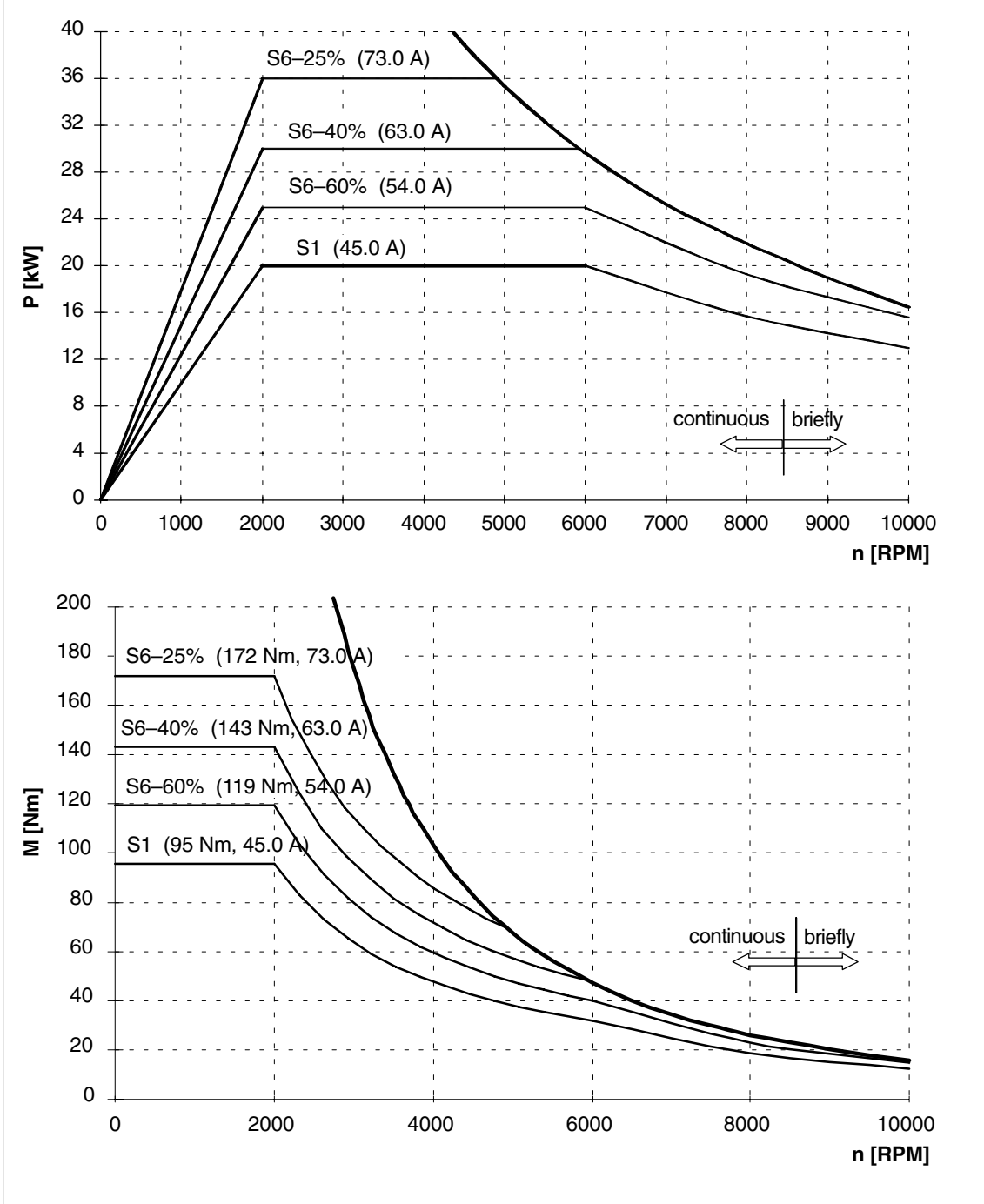

Fig. 2-24 1PH7133-□NG□□-0L

Table 2-28 Induction motor 1PH7135-□NF

P_N [kW]	n_N [RPM]	M_N [Nm]	I_N [A]	n_{max} [RPM]	T_{th} [min]	J [kgm ²]	m [kg]
18.5	1500	118	42	8000	30	0.109	130

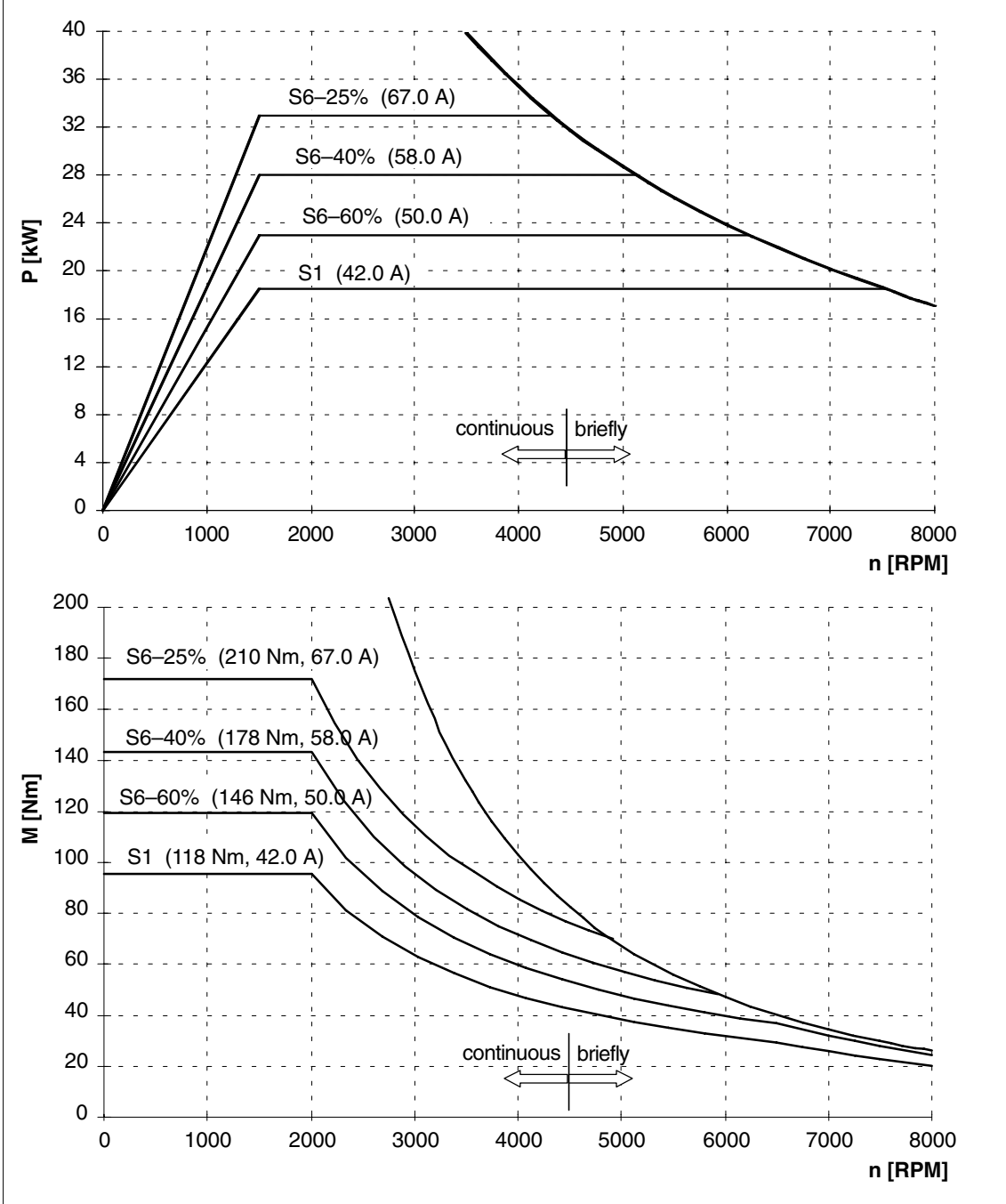

Fig. 2-25 1PH7135-□NF

2.2 Power-speed and torque-speed diagrams

Table 2-29 Induction motor 1PH7135-□NF□□-0L

P_N [kW]	n_N [RPM]	M_N [Nm]	I_N [A]	n_{max} [RPM]	T_{th} [min]	J [kgm ²]	m [kg]
18.5	1500	118	42	10000	30	0.109	130

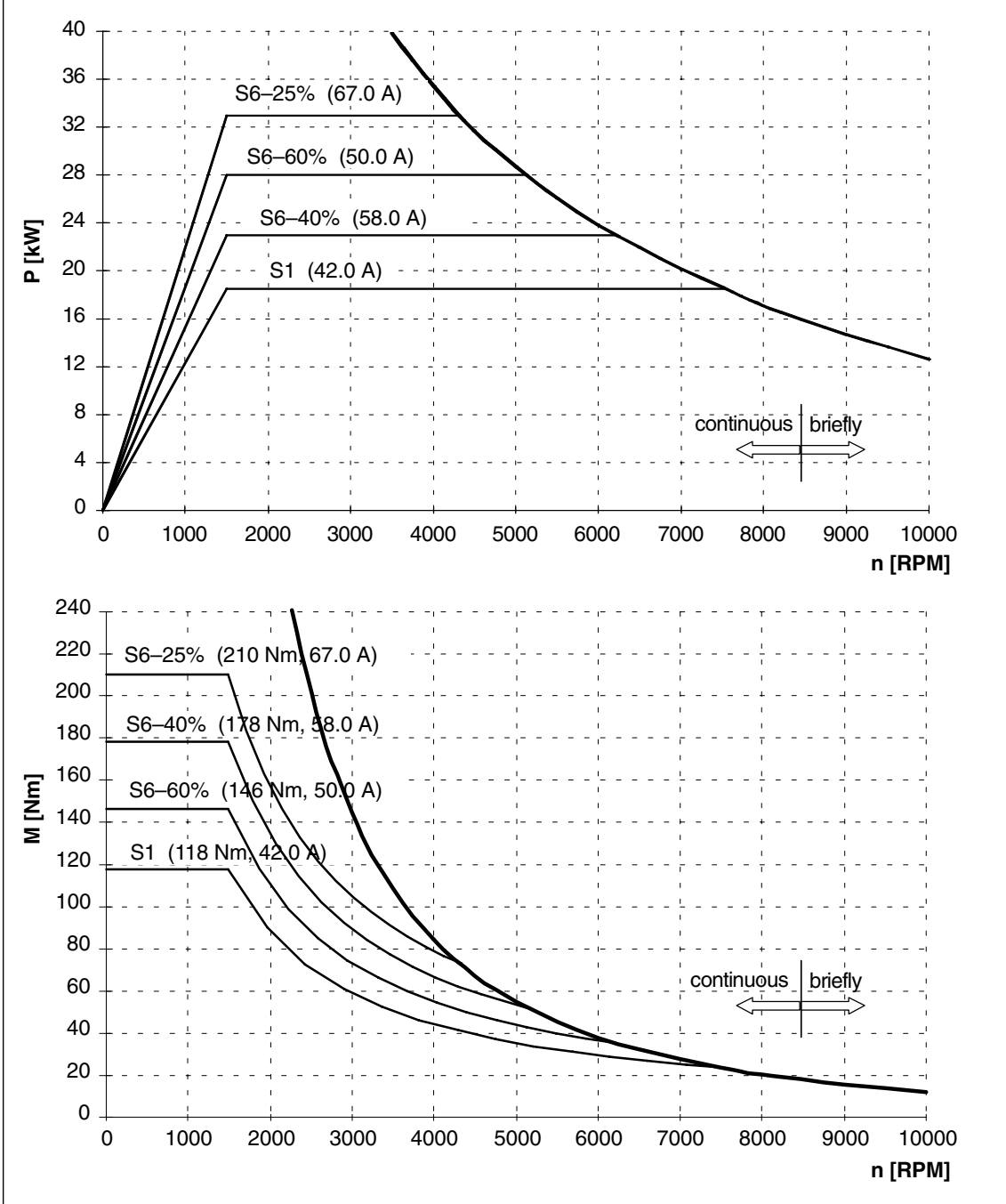

Fig. 2-26 1PH7135-□NF□□-0L

Table 2-30 Induction motor 1PH7137-□ND□□

P_N [kW]	n_N [RPM]	M_N [Nm]	I_N [A]	n_{max} [RPM]	T_{th} [min]	J [kgm ²]	m [kg]
17	1000	162	43	8000	30	0.109	130

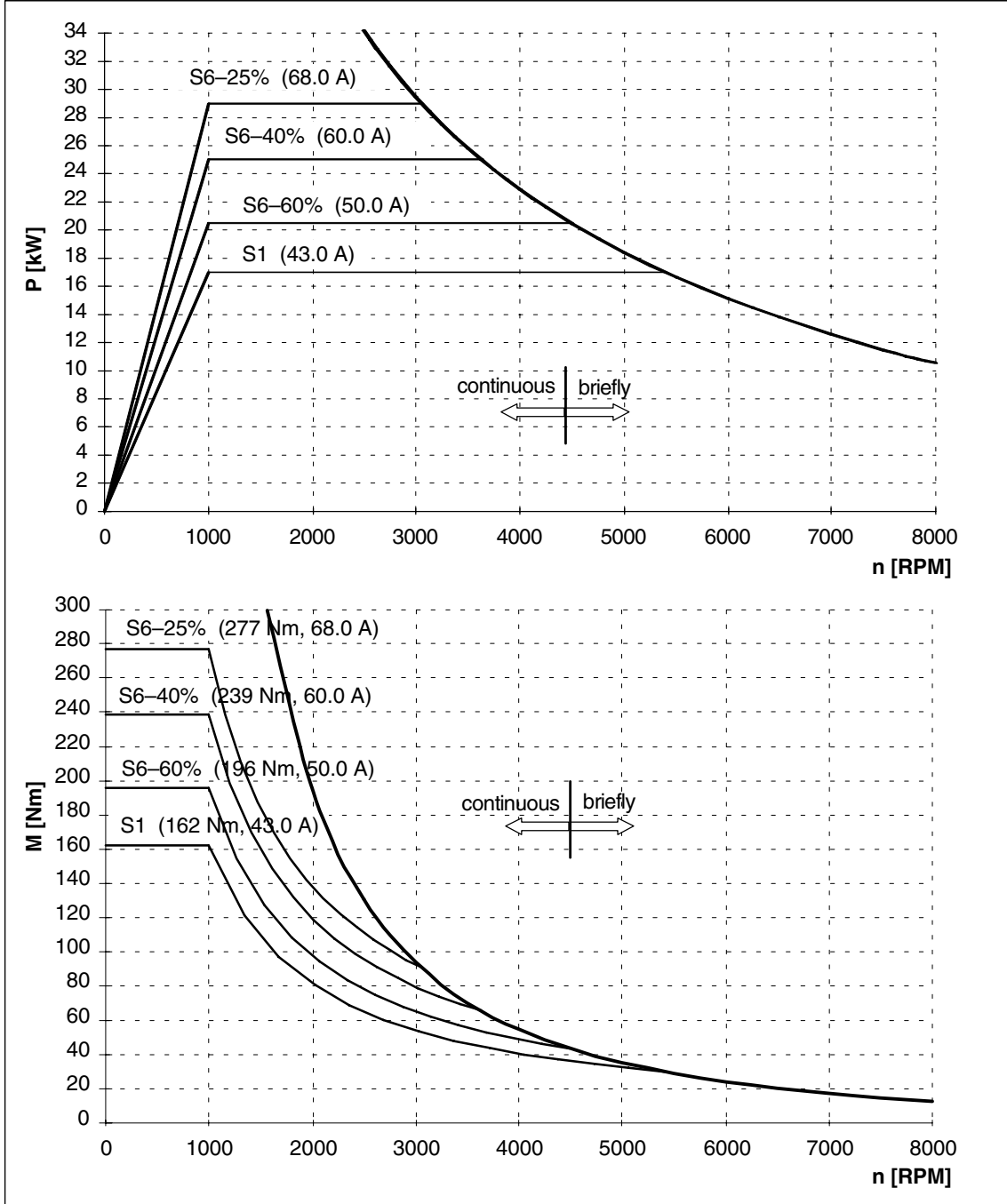

Fig. 2-27 1PH7137-□ND□□

2.2 Power-speed and torque-speed diagrams

Table 2-31 Induction motor 1PH7137-□ND□□-0L

P_N [kW]	n_N [RPM]	M_N [Nm]	I_N [A]	n_{max} [RPM]	T_{th} [min]	J [kgm ²]	m [kg]
17	1000	162	43	10000	30	0.109	130

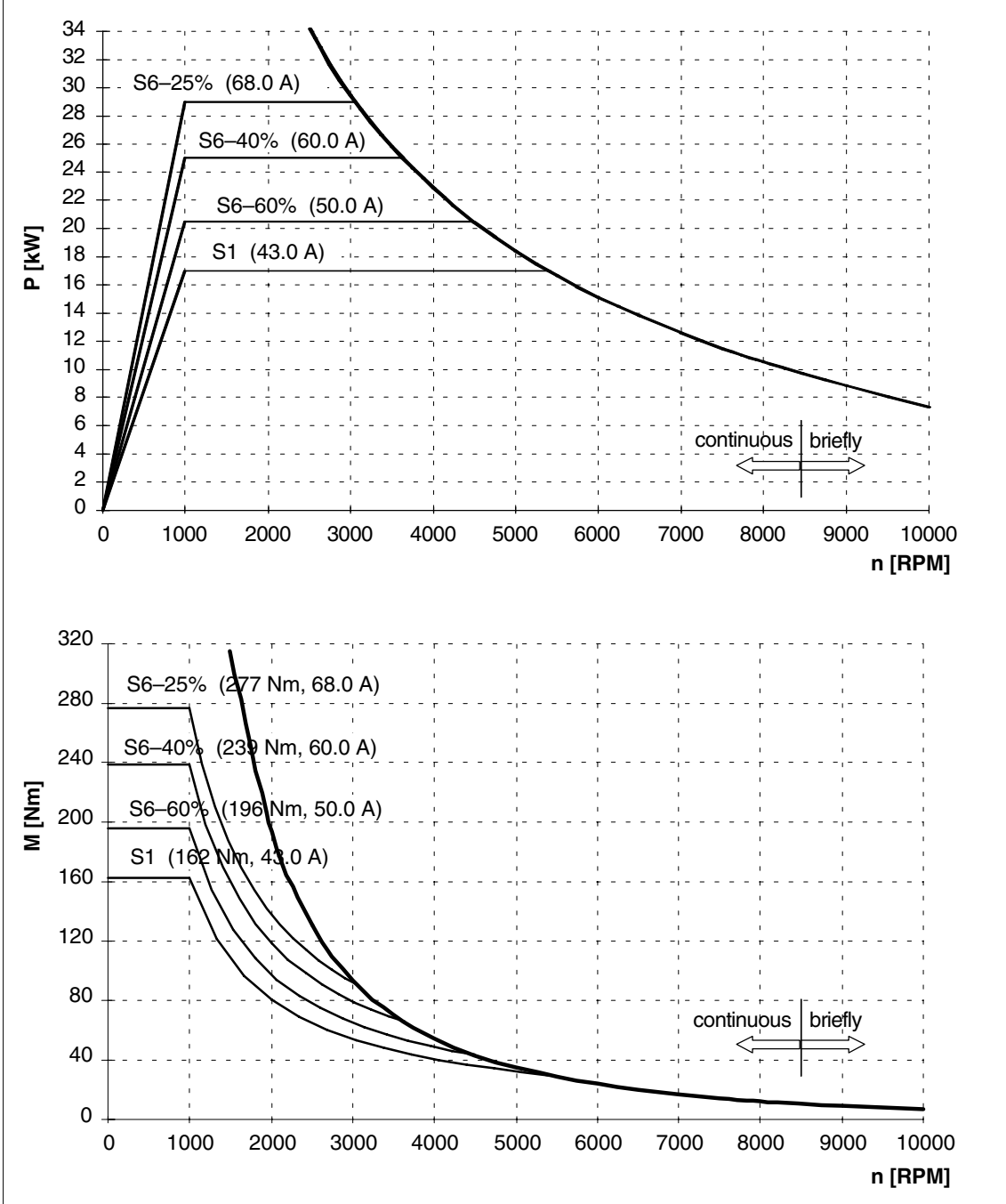

Fig. 2-28 1PH7137-□ND□□-0L

Table 2-32 Induction motor 1PH7137-□NF□□

P_N [kW]	n_N [RPM]	M_N [Nm]	I_N [A]	n_{max} [RPM]	T_{th} [min]	J [kgm ²]	m [kg]
22	1500	140	57	8000	30	0.109	130

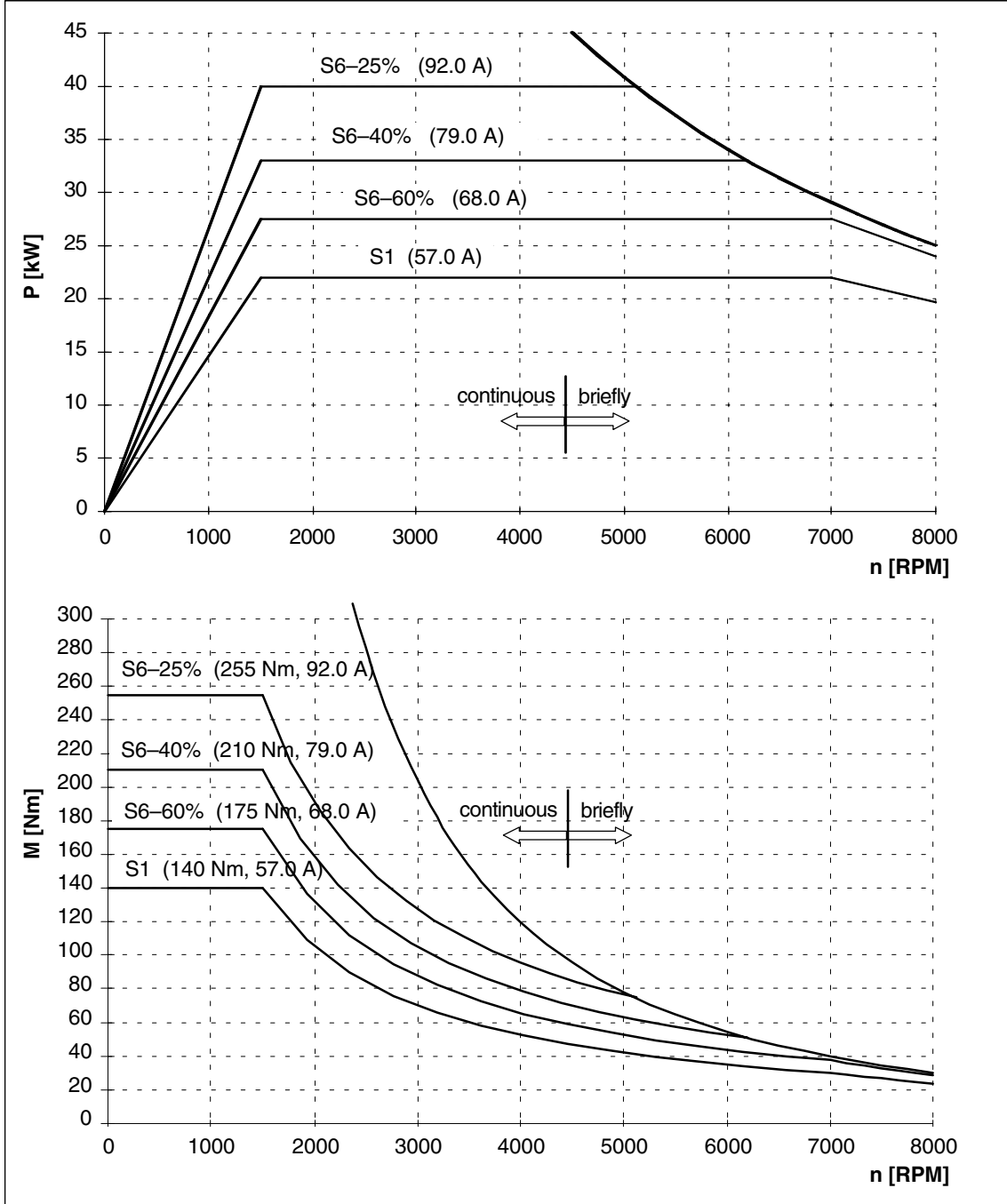

Fig. 2-29 1PH7137-□NF□□

2.2 Power-speed and torque-speed diagrams

Table 2-33 Induction motor 1PH7137-□NF□□-0L

P_N [kW]	n_N [RPM]	M_N [Nm]	I_N [A]	n_{max} [RPM]	T_{th} [min]	J [kgm ²]	m [kg]
22	1500	140	57	10000	30	0.109	130

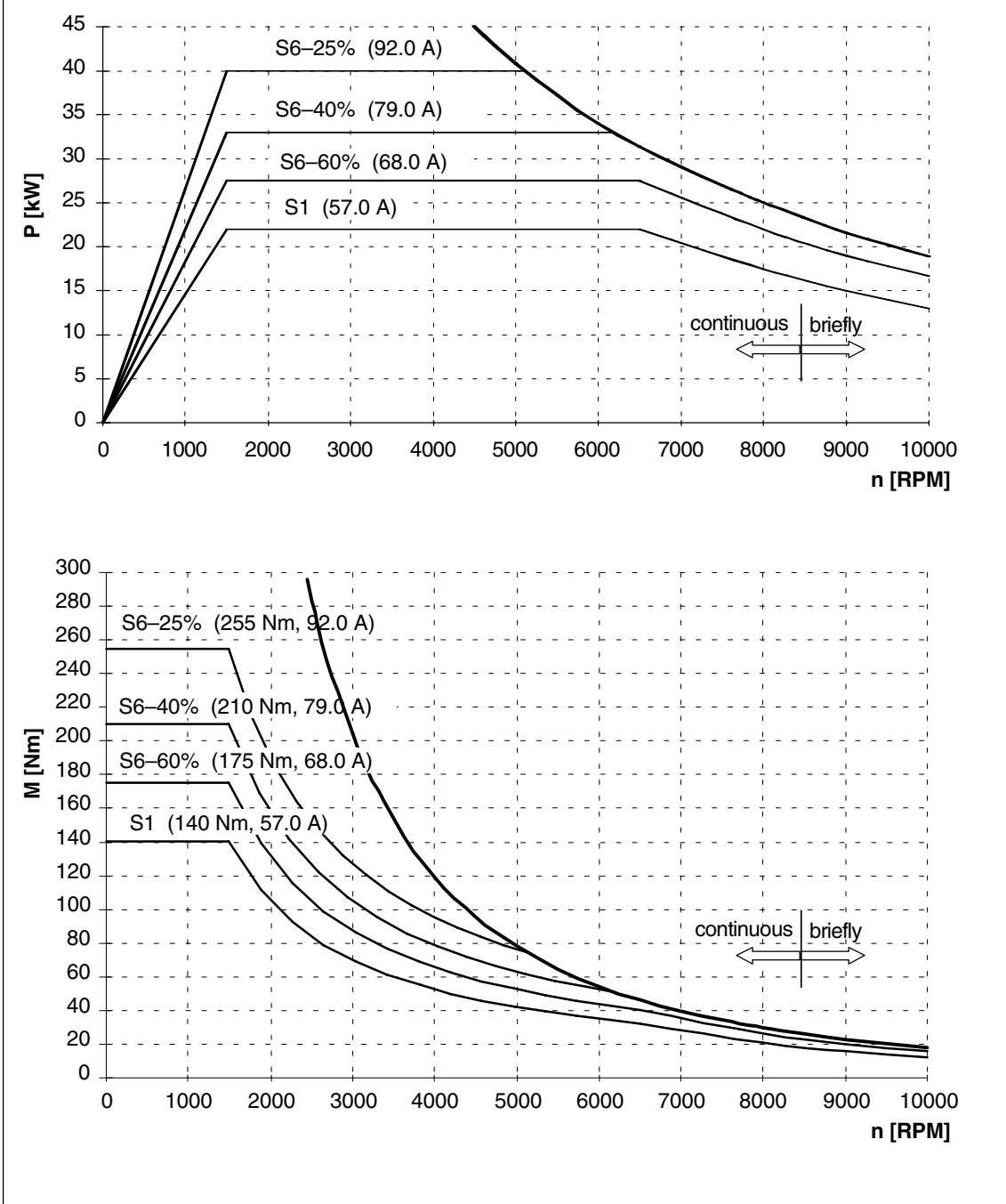

Fig. 2-30 1PH7137-□NF□□-0L

Table 2-34 Induction motor 1PH7137-□NG□□

P_N [kW]	n_N [RPM]	M_N [Nm]	I_N [A]	n_{max} [RPM]	T_{th} [min]	J [kgm ²]	m [kg]
28	2000	134	60	8000	30	0.109	130

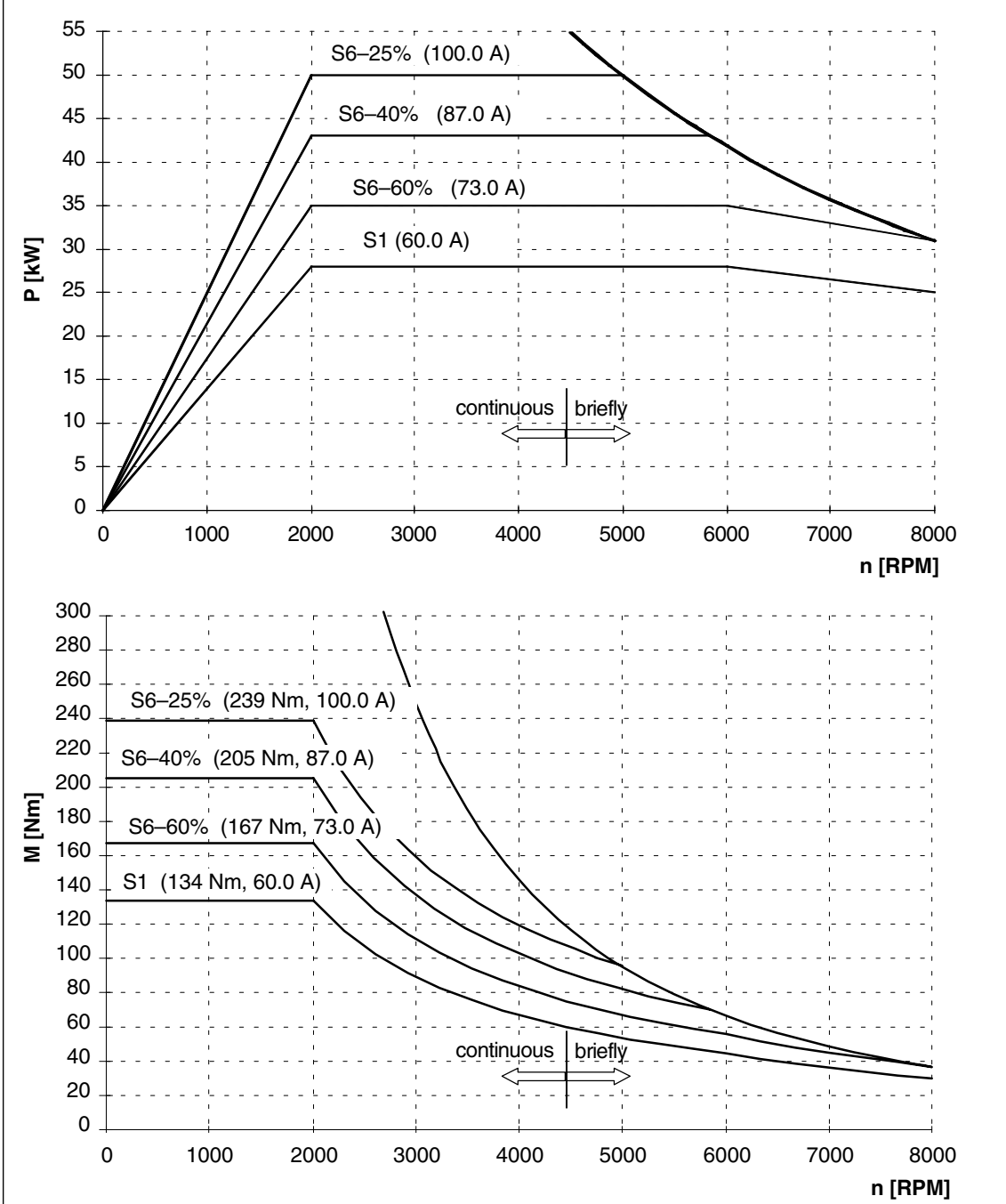

Fig. 2-31 1PH7137-□NG□□

2.2 Power-speed and torque-speed diagrams

Table 2-35 Induction motor 1PH7137-□NG□□-0L

P_N [kW]	n_N [RPM]	M_N [Nm]	I_N [A]	n_{max} [RPM]	T_{th} [min]	J [kgm ²]	m [kg]
28	2000	134	60	10000	30	0.109	130

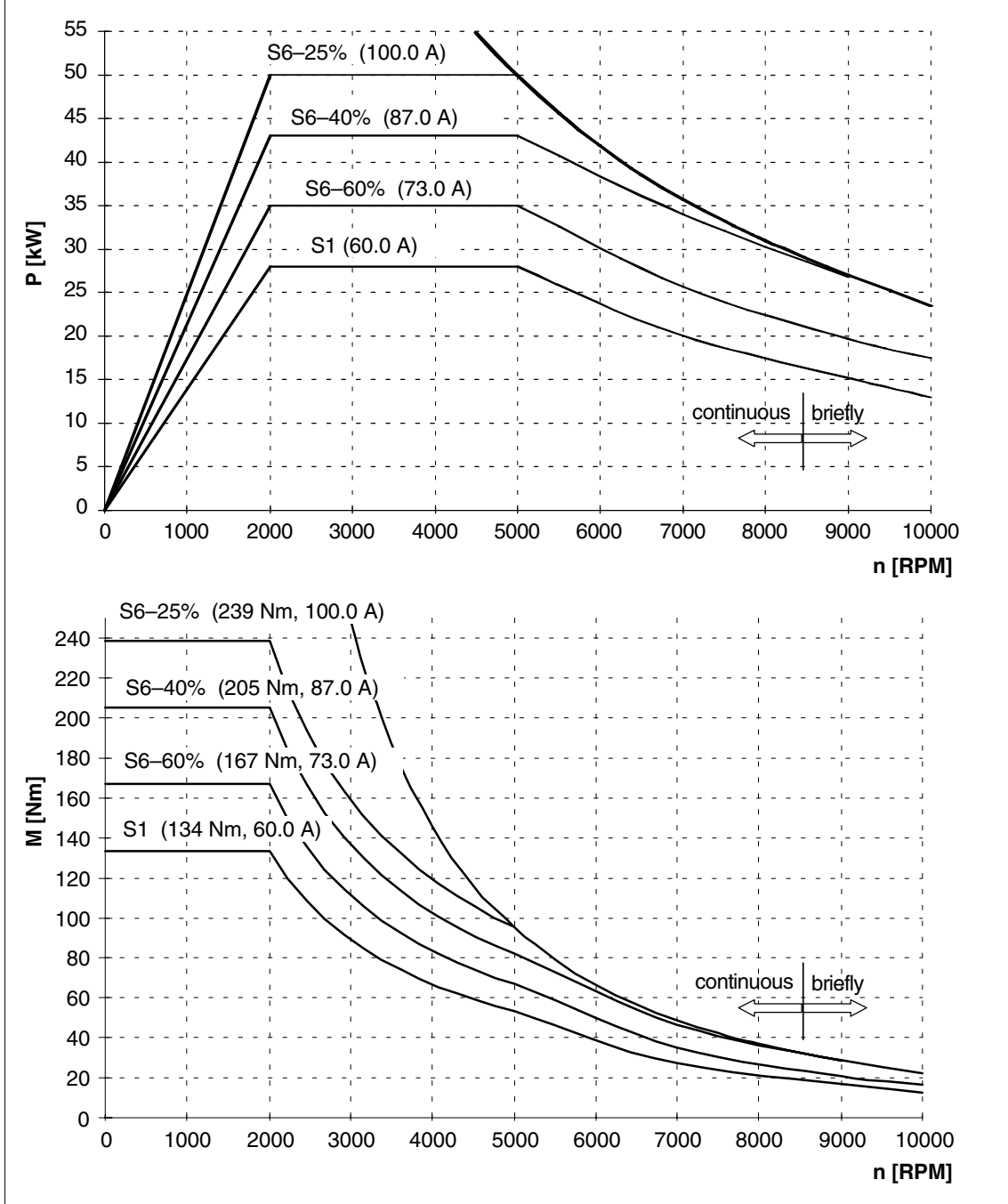

Fig. 2-32 1PH7137-□NG□□-0L

Table 2-36 Induction motor 1PH7163-□NB

P_N [kW]	n_N [RPM]	M_N [Nm]	I_N [A]	n_{max} [RPM]	T_{th} [min]	J [kgm ²]	m [kg]
12	500	229	30	6500	35	0.19	180

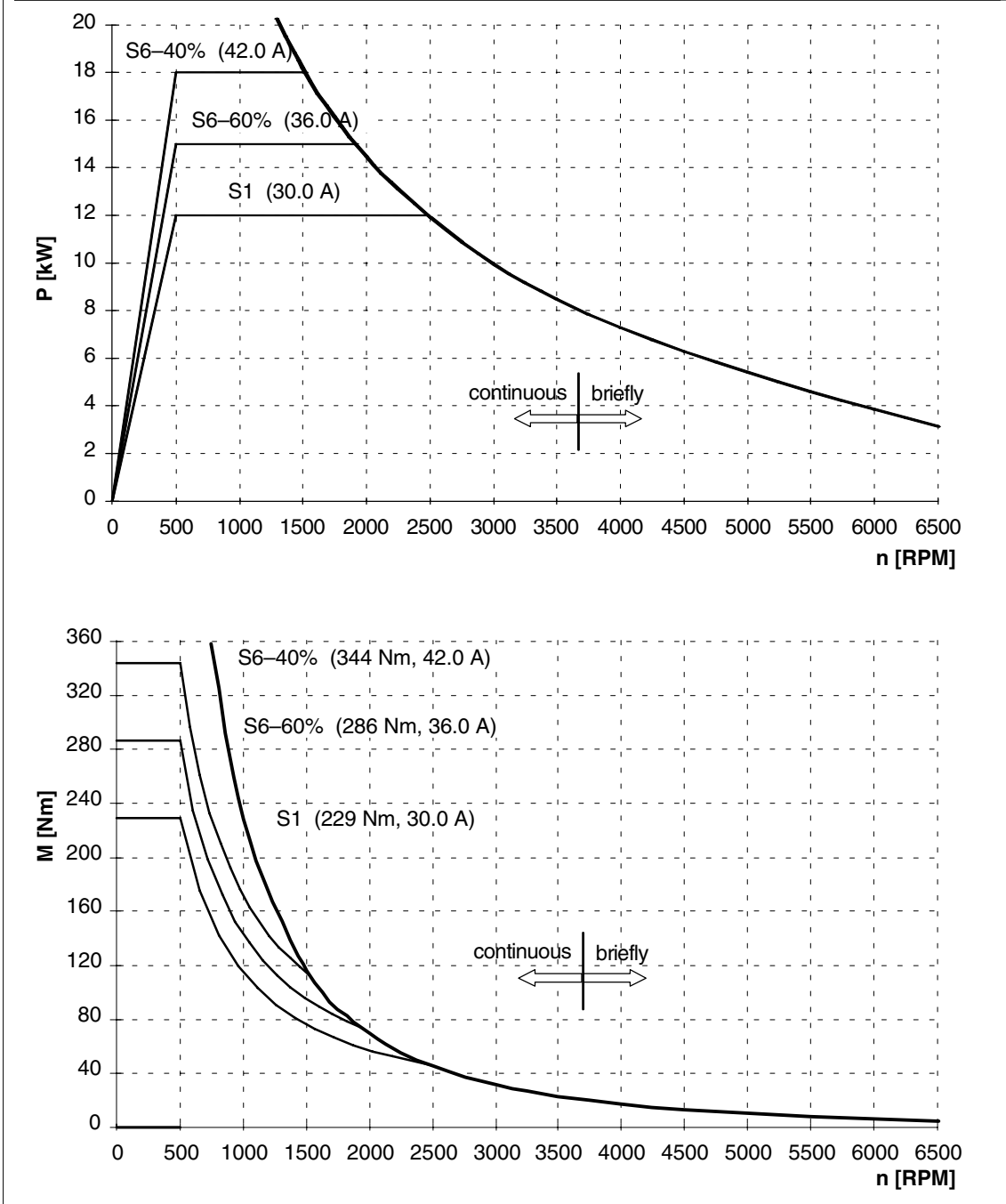

Fig. 2-33 1PH7163-□NB

2.2 Power-speed and torque-speed diagrams

Table 2-37 Induction motor 1PH7163-□NB□□-0L

P_N [kW]	n_N [RPM]	M_N [Nm]	I_N [A]	n_{max} [RPM]	T_{th} [min]	J [kgm ²]	m [kg]
12	500	229	30	8000	35	0.19	180

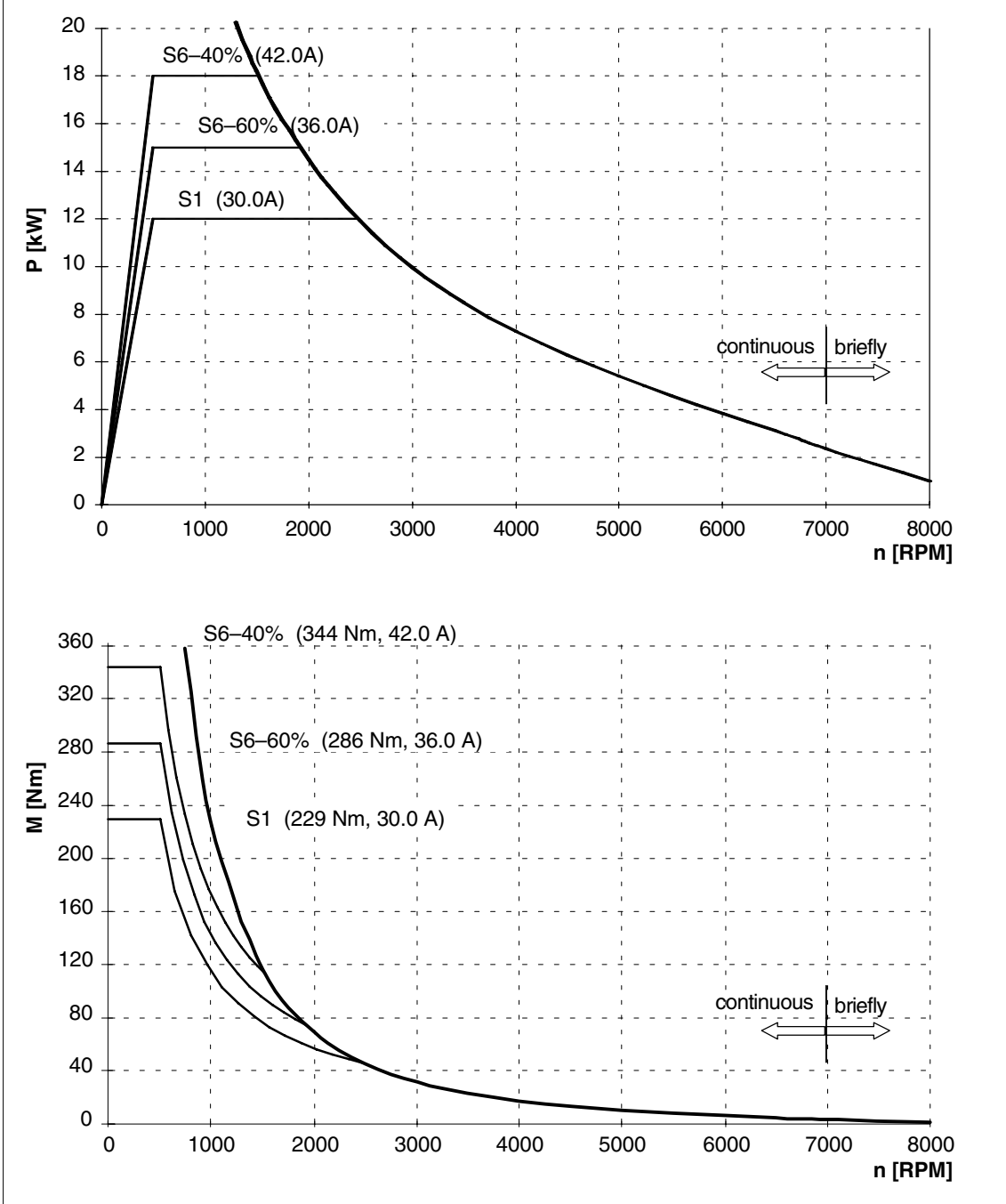

Fig. 2-34 1PH7163-□NB□□-0L

Table 2-38 Induction motor 1PH7163-□ND□□

P_N [kW]	n_N [RPM]	M_N [Nm]	I_N [A]	n_{max} [RPM]	T_{th} [min]	J [kgm ²]	m [kg]
22	1000	210	55	6500	35	0.19	180

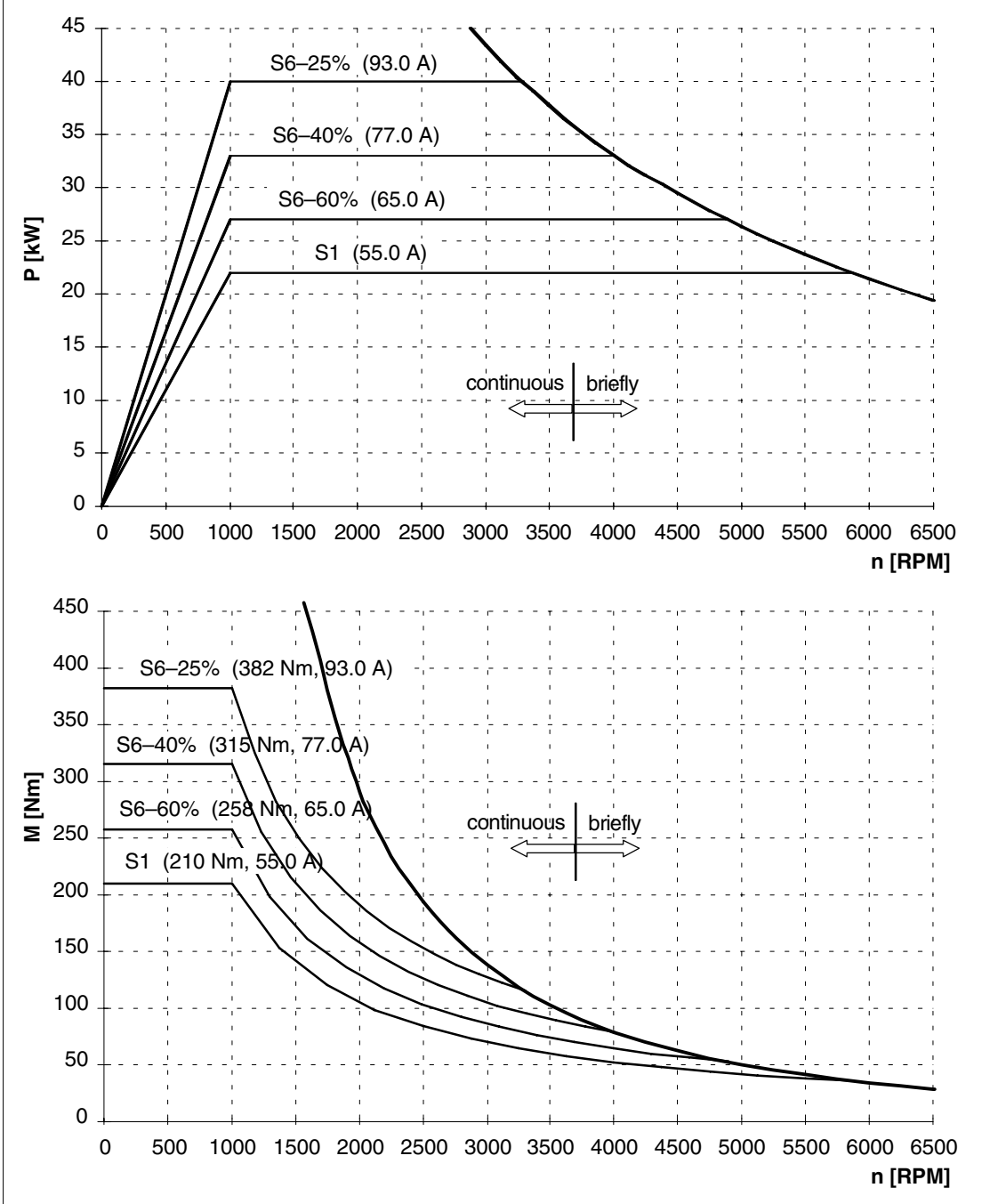

Fig. 2-35 1PH7163-□ND□□

2.2 Power-speed and torque-speed diagrams

Table 2-39 Induction motor 1PH7163-□ND□□-0L

P_N [kW]	n_N [RPM]	M_N [Nm]	I_N [A]	n_{max} [RPM]	T_{th} [min]	J [kgm ²]	m [kg]
22	1000	210	55	8000	35	0.19	180

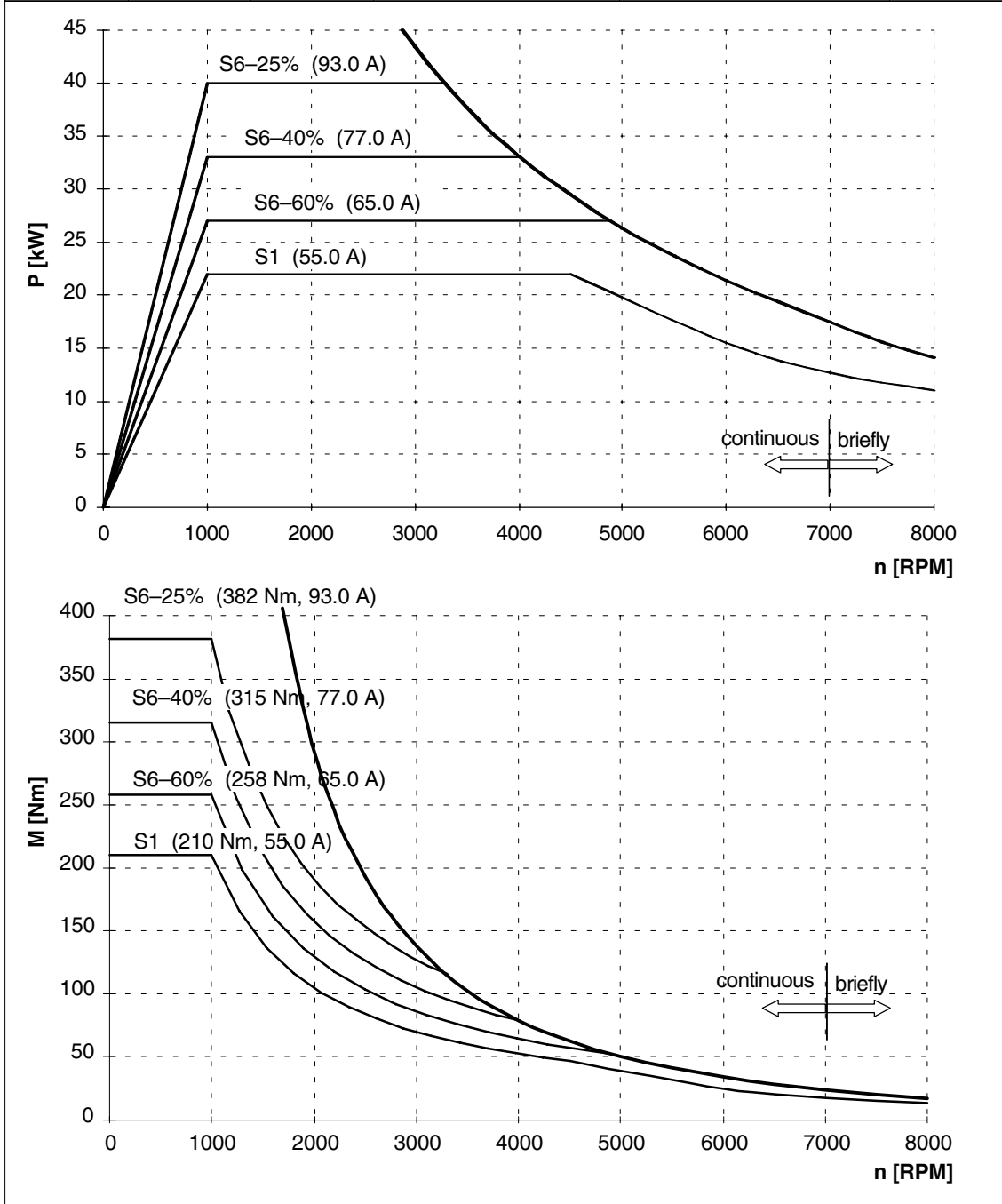

Fig. 2-36 1PH7163-□ND□□-0L

Table 2-40 Induction motor 1PH7163-□NF□□

P_N [kW]	n_N [RPM]	M_N [Nm]	I_N [A]	n_{max} [RPM]	T_{th} [min]	J [kgm ²]	m [kg]
30	1500	191	72	6500	35	0.19	180

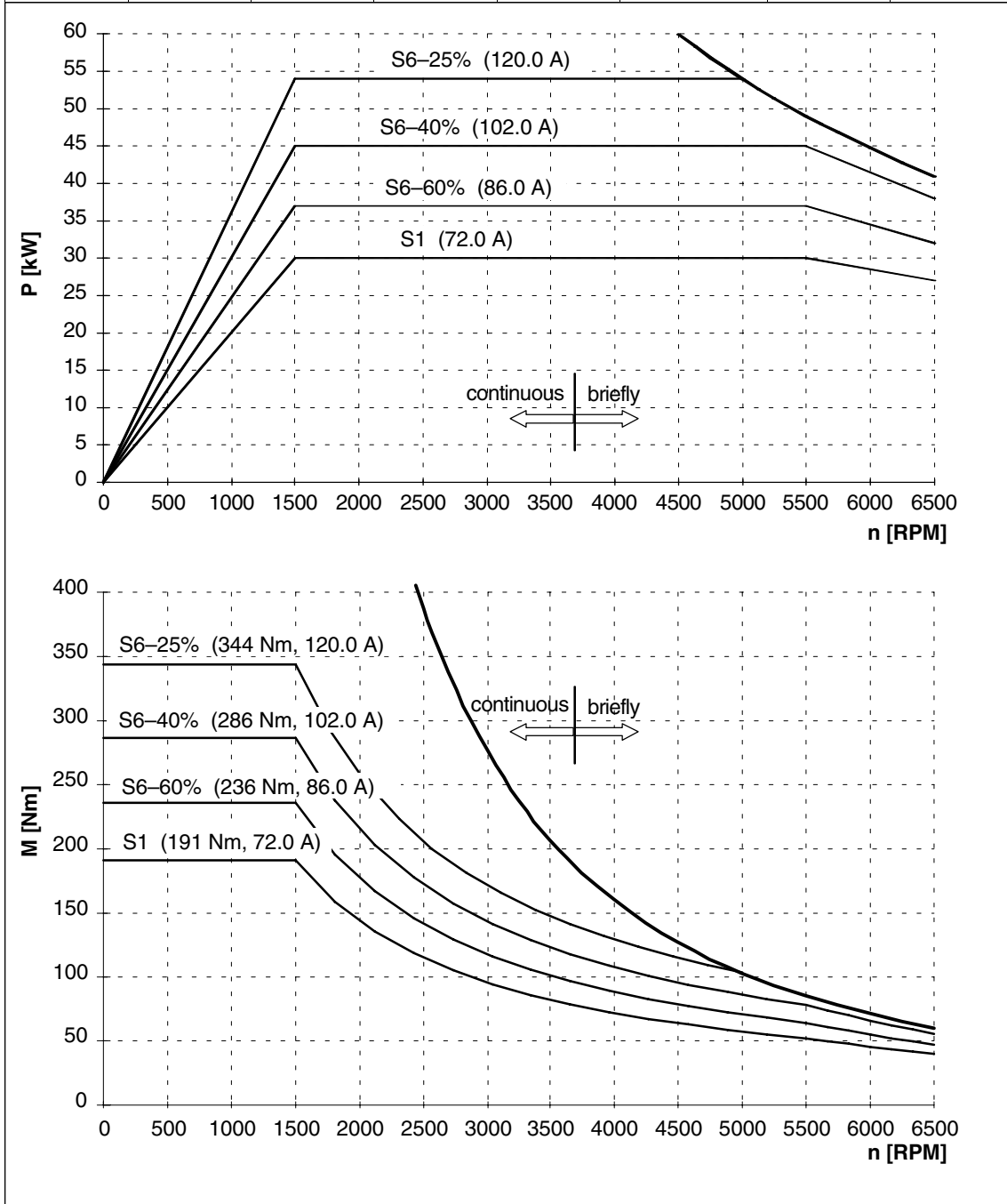

Fig. 2-37 1PH7163-□NF□□

2.2 Power-speed and torque-speed diagrams

Table 2-41 Induction motor 1PH7163-□NF□□-0L

P_N [kW]	n_N [RPM]	M_N [Nm]	I_N [A]	n_{max} [RPM]	T_{th} [min]	J [kgm ²]	m [kg]
30	1500	191	72	8000	35	0.19	180

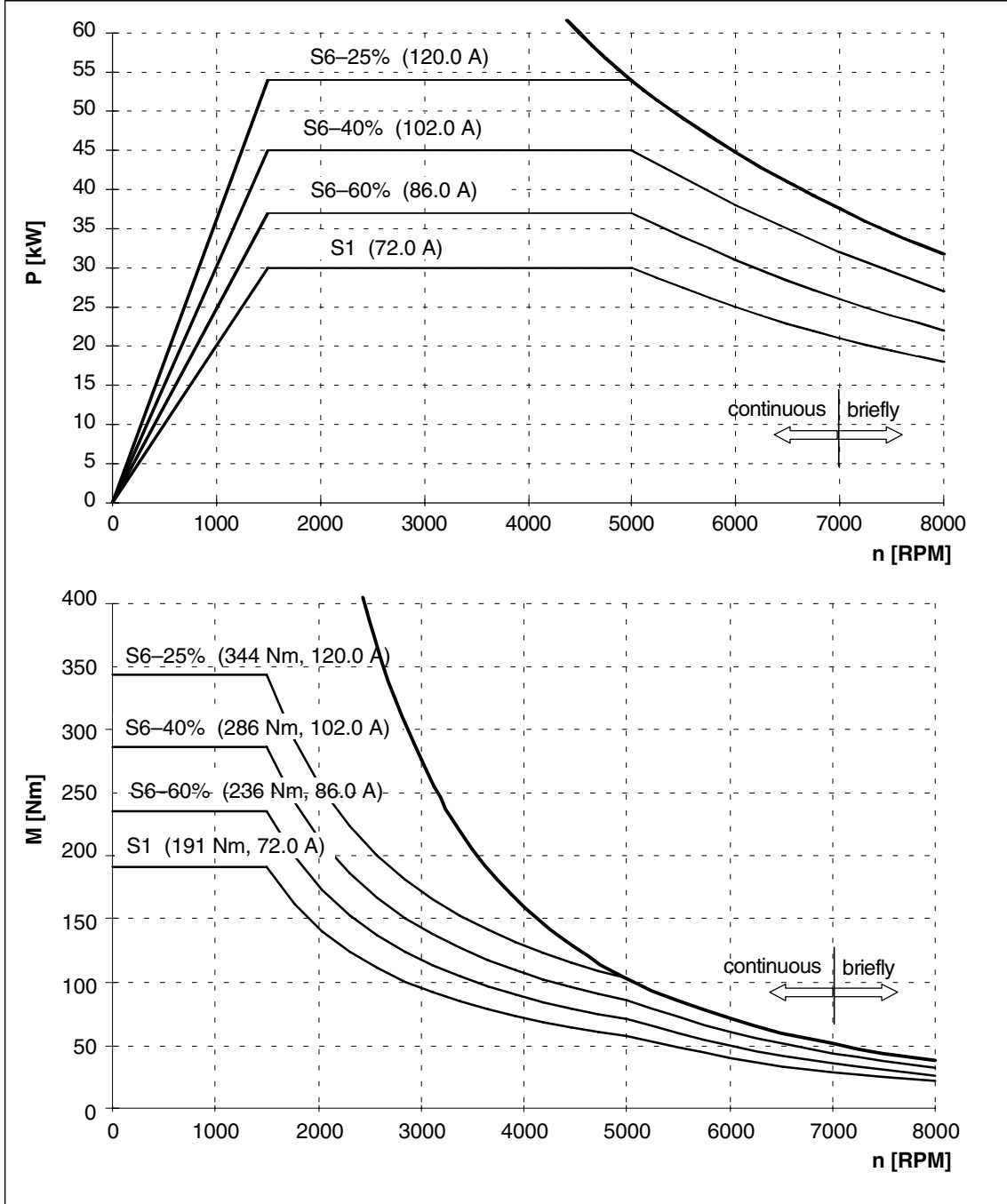

Fig. 2-38 1PH7163-□NF□□-0L

Table 2-42 Induction motor 1PH7163-□NG4

P_N [kW]	n_N [RPM]	M_N [Nm]	I_N [A]	n_{max} [RPM]	T_{th} [min]	J [kgm ²]	m [kg]
36	2000	172	85	6500	35	0.19	180

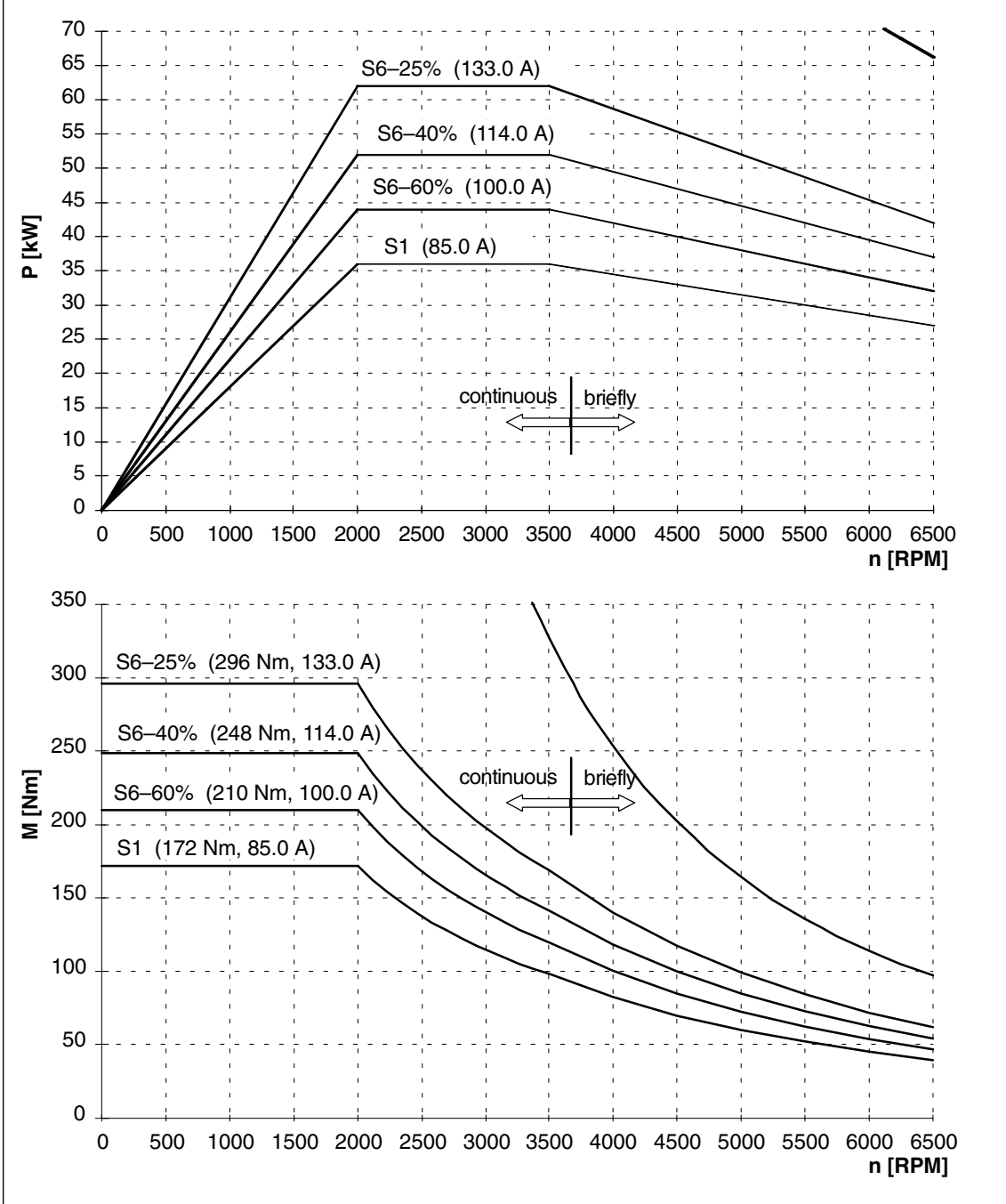

Fig. 2-39 1PH7163-□NG4

2.2 Power-speed and torque-speed diagrams

Table 2-43 Induction motor 1PH7163-□NG4□□-0L

P_N [kW]	n_N [RPM]	M_N [Nm]	I_N [A]	n_{max} [RPM]	T_{th} [min]	J [kgm ²]	m [kg]
36	2000	172	85	8000	35	0.19	180

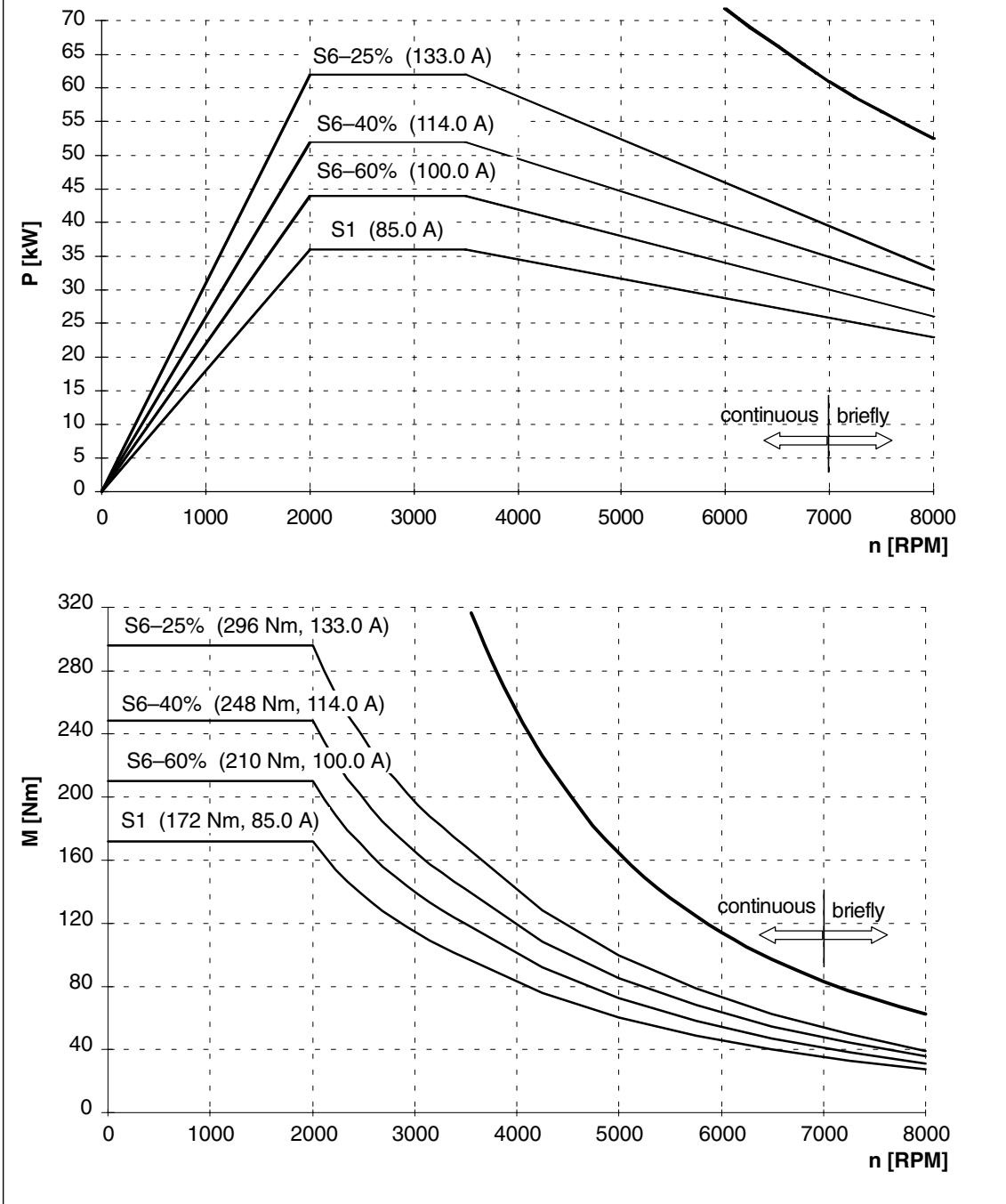

Fig. 2-40 1PH7163-□NG4□□-0L

Table 2-44 Induction motor 1PH7167-□NB4

P_N [kW]	n_N [RPM]	M_N [Nm]	I_N [A]	n_{max} [RPM]	T_{th} [min]	J [kgm ²]	m [kg]
16	500	306	37	6500	35	0.23	228

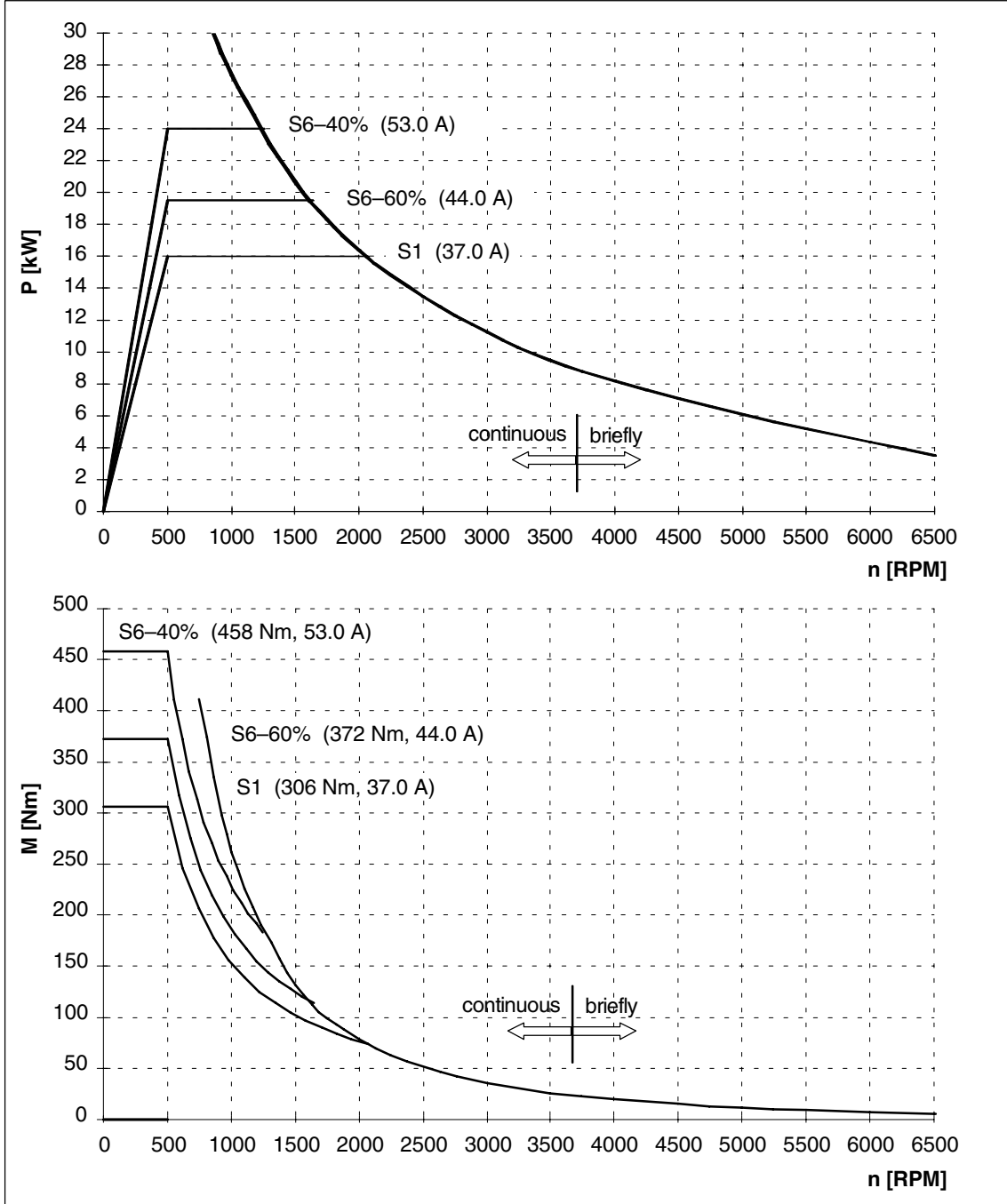

Fig. 2-41 1PH7167-□NB4

2.2 Power-speed and torque-speed diagrams

Table 2-45 Induction motor 1PH7167-□NB4□□-0L

P_N [kW]	n_N [RPM]	M_N [Nm]	I_N [A]	n_{max} [RPM]	T_{th} [min]	J [kgm ²]	m [kg]
16	500	306	37	8000	35	0.23	228

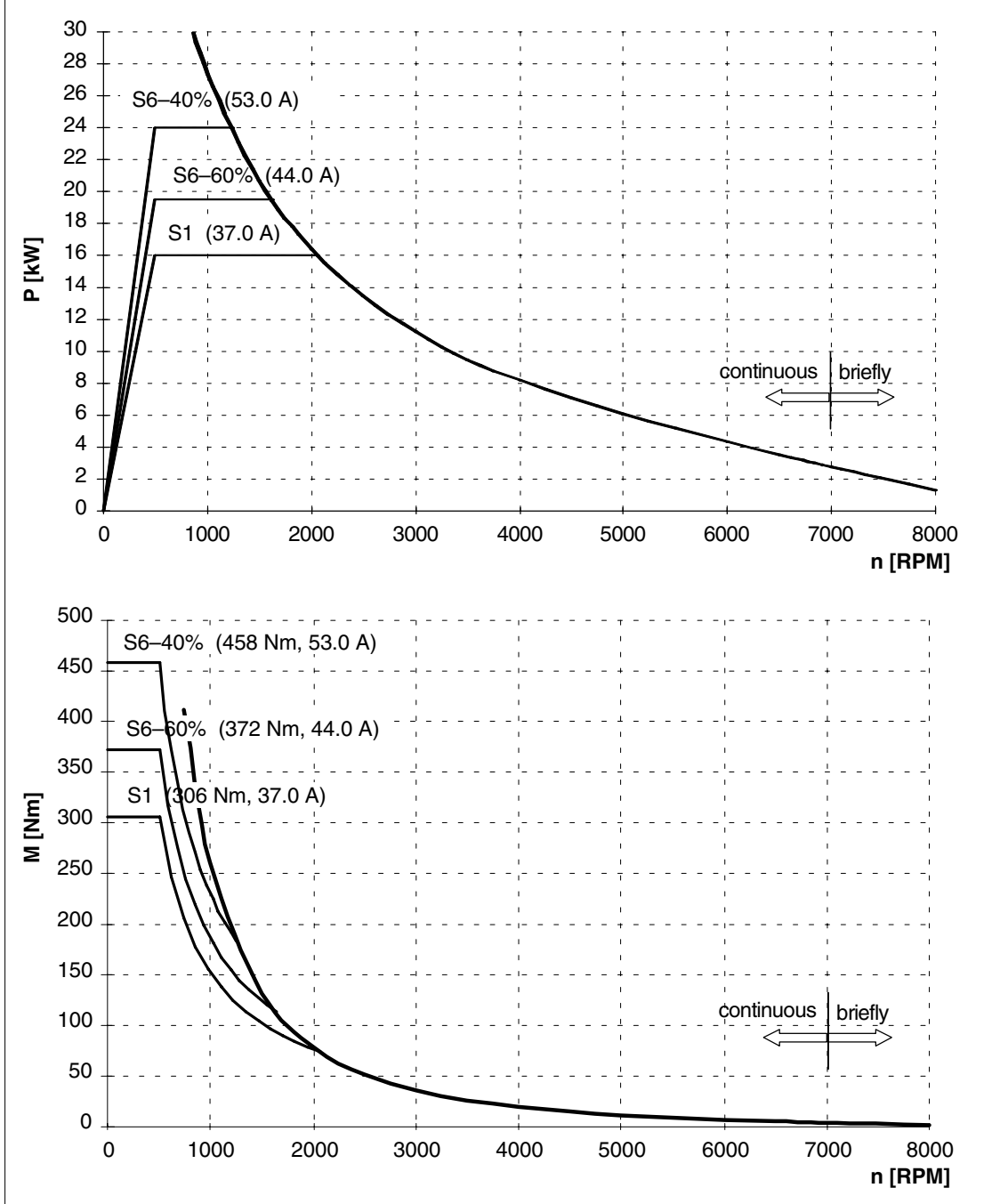

Fig. 2-42 1PH7167-□NB4□□-0L

Table 2-46 Induction motor 1PH7167-□ND4

P_N [kW]	n_N [RPM]	M_N [Nm]	I_N [A]	n_{max} [RPM]	T_{th} [min]	J [kgm ²]	m [kg]
28	1000	267	71	6500	35	0.23	228

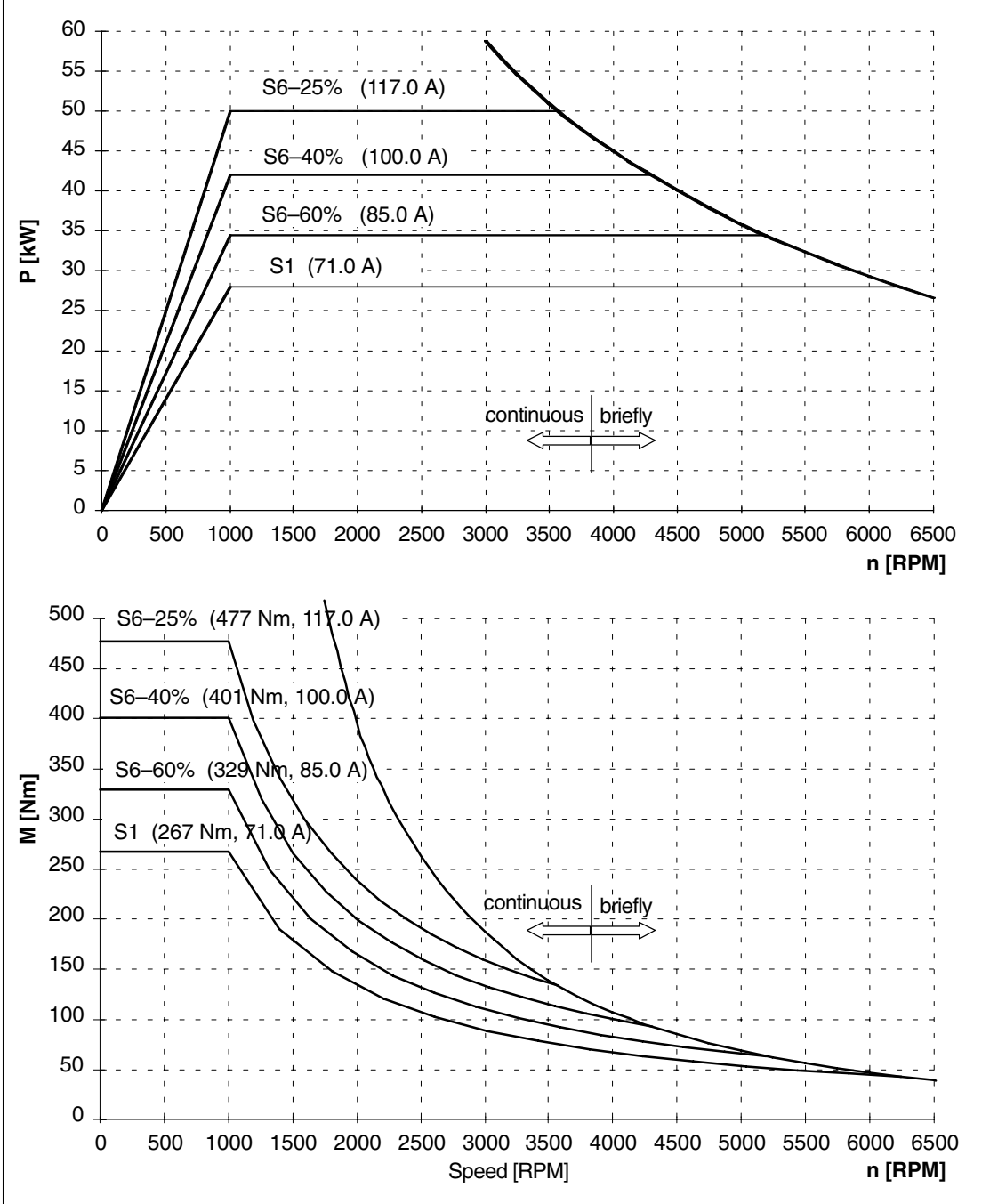

Fig. 2-43 1PH7167-□ND4

2.2 Power-speed and torque-speed diagrams

Table 2-47 Induction motor 1PH7167-□ND4□□-0L

P_N [kW]	n_N [RPM]	M_N [Nm]	I_N [A]	n_{max} [RPM]	T_{th} [min]	J [kgm ²]	m [kg]
28	1000	267	71	8000	35	0.23	228

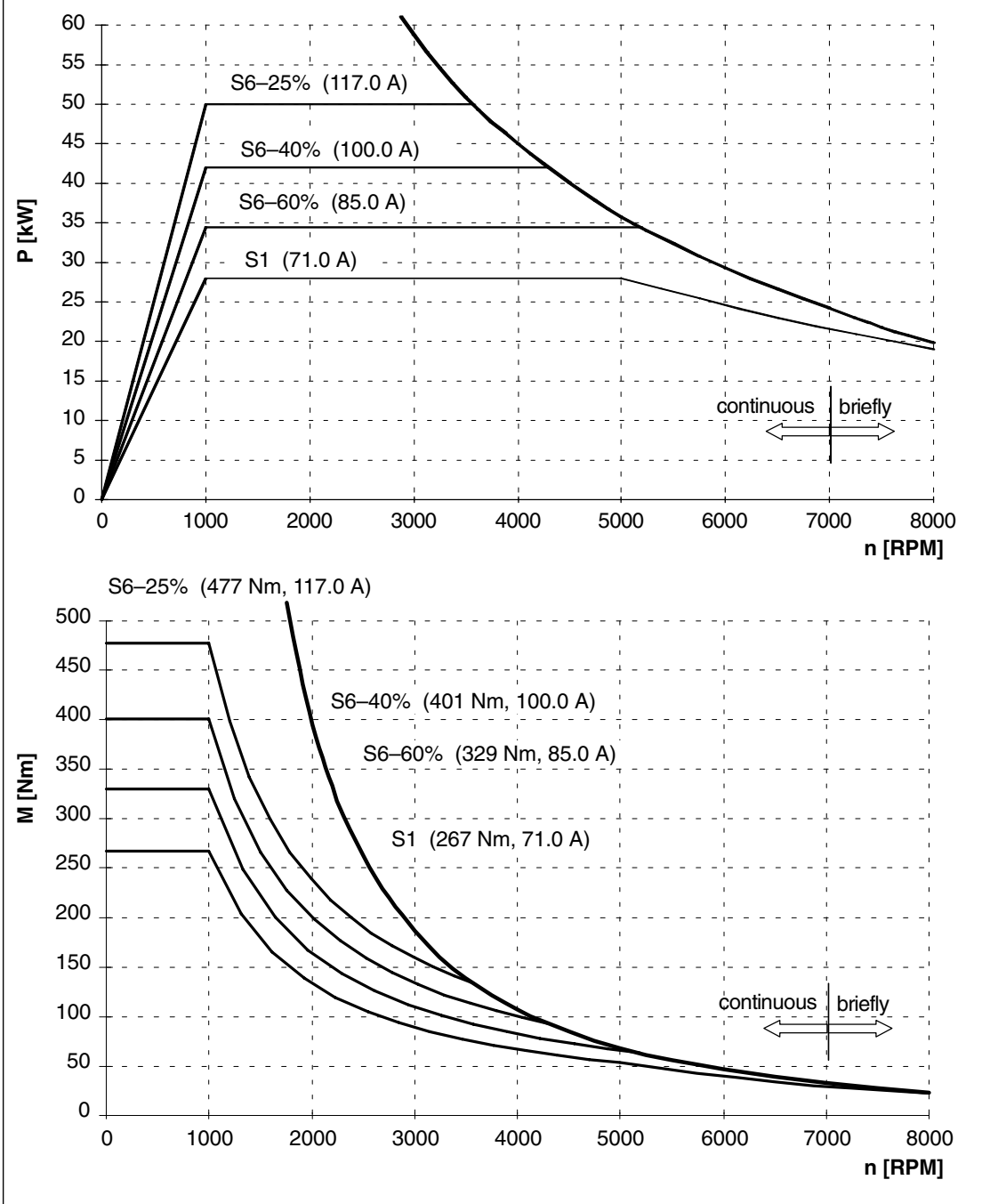

Fig. 2-44 1PH7167-□ND4□□-0L

Table 2-48 Induction motor 1PH7167-□NF□□

P_N [kW]	n_N [RPM]	M_N [Nm]	I_N [A]	n_{max} [RPM]	T_{th} [min]	J [kgm ²]	m [kg]
37	1500	236	82	6500	35	0.23	228

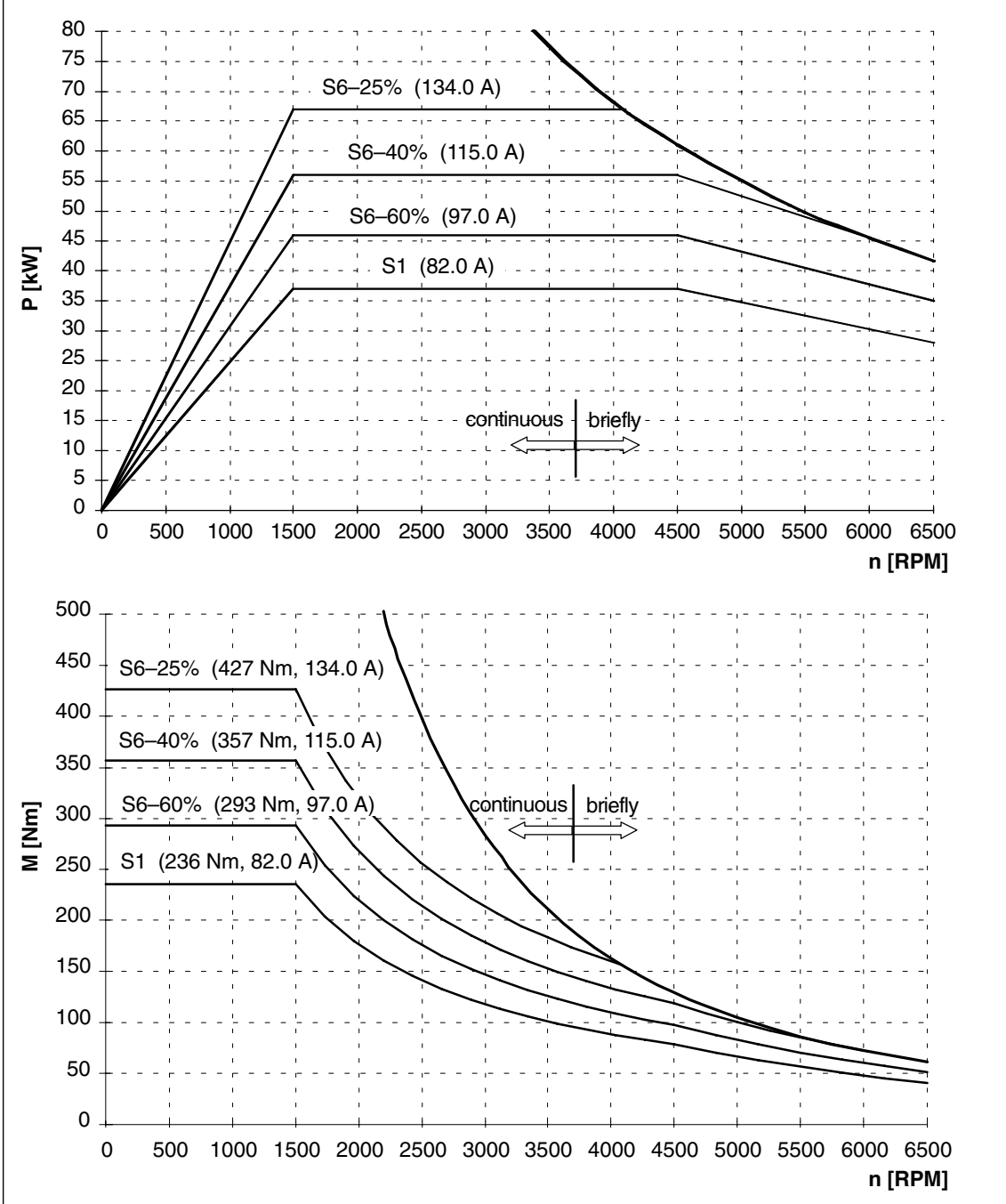

Fig. 2-45 1PH7167-□NF□□

2.2 Power-speed and torque-speed diagrams

Table 2-49 Induction motor 1PH7167-□NF□□-0L

P_N [kW]	n_N [RPM]	M_N [Nm]	I_N [A]	n_{max} [RPM]	T_{th} [min]	J [kgm ²]	m [kg]
37	1500	236	82	8000	35	0.23	228

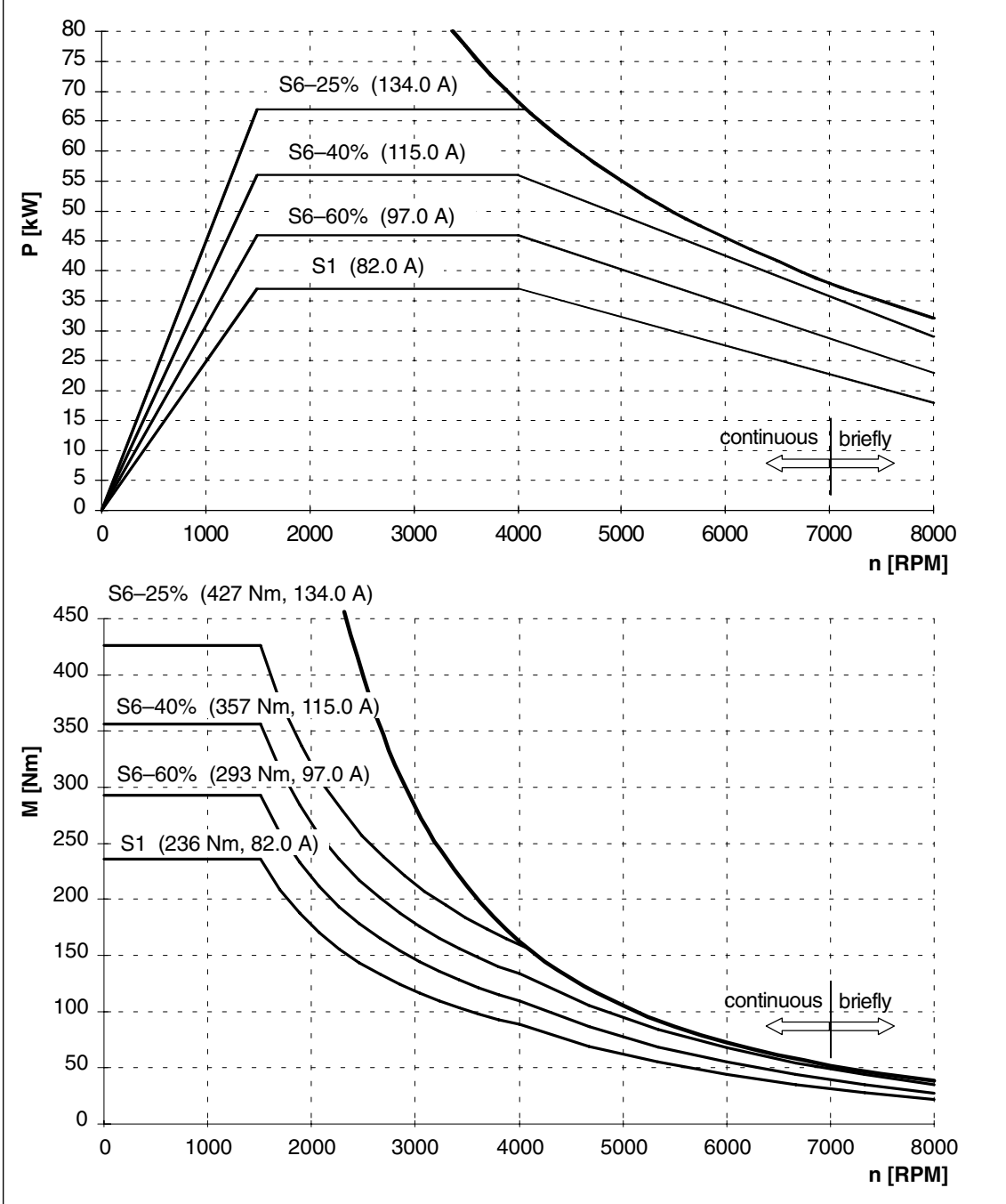

Fig. 2-46 1PH7167-□NF□□-0L

Table 2-50 Induction motor 1PH7167-□NG

P_N [kW]	n_N [RPM]	M_N [Nm]	I_N [A]	n_{max} [RPM]	T_{th} [min]	J [kgm ²]	m [kg]
41	2000	196	89	6500	35	0.23	228

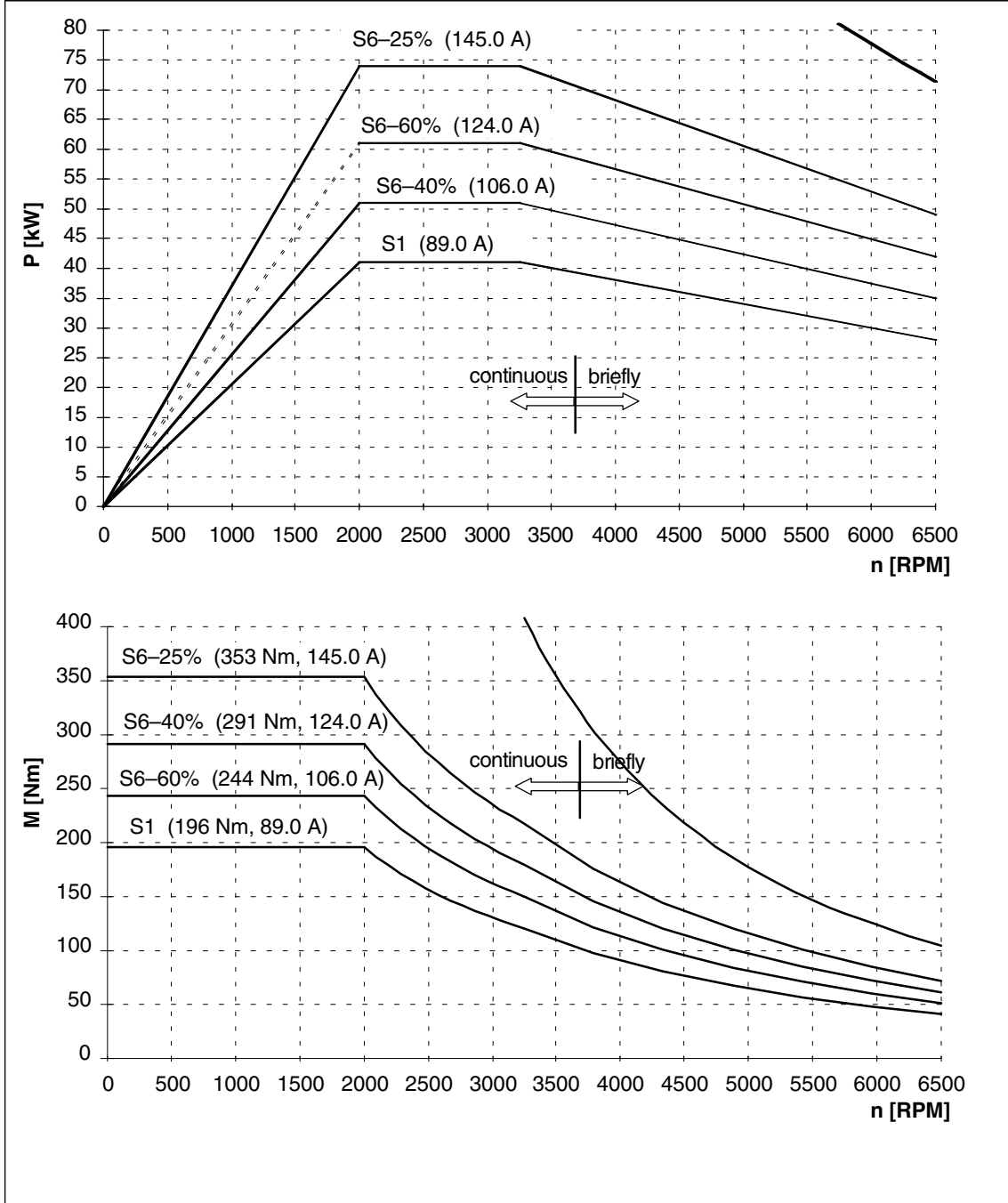

Fig. 2-47 1PH7167-□NG

2.2 Power-speed and torque-speed diagrams

Table 2-51 Induction motor 1PH7167-□NG□□-0L

P_N [kW]	n_N [RPM]	M_N [Nm]	I_N [A]	n_{max} [RPM]	T_{th} [min]	J [kgm ²]	m [kg]
41	2000	196	89	8000	35	0.23	228

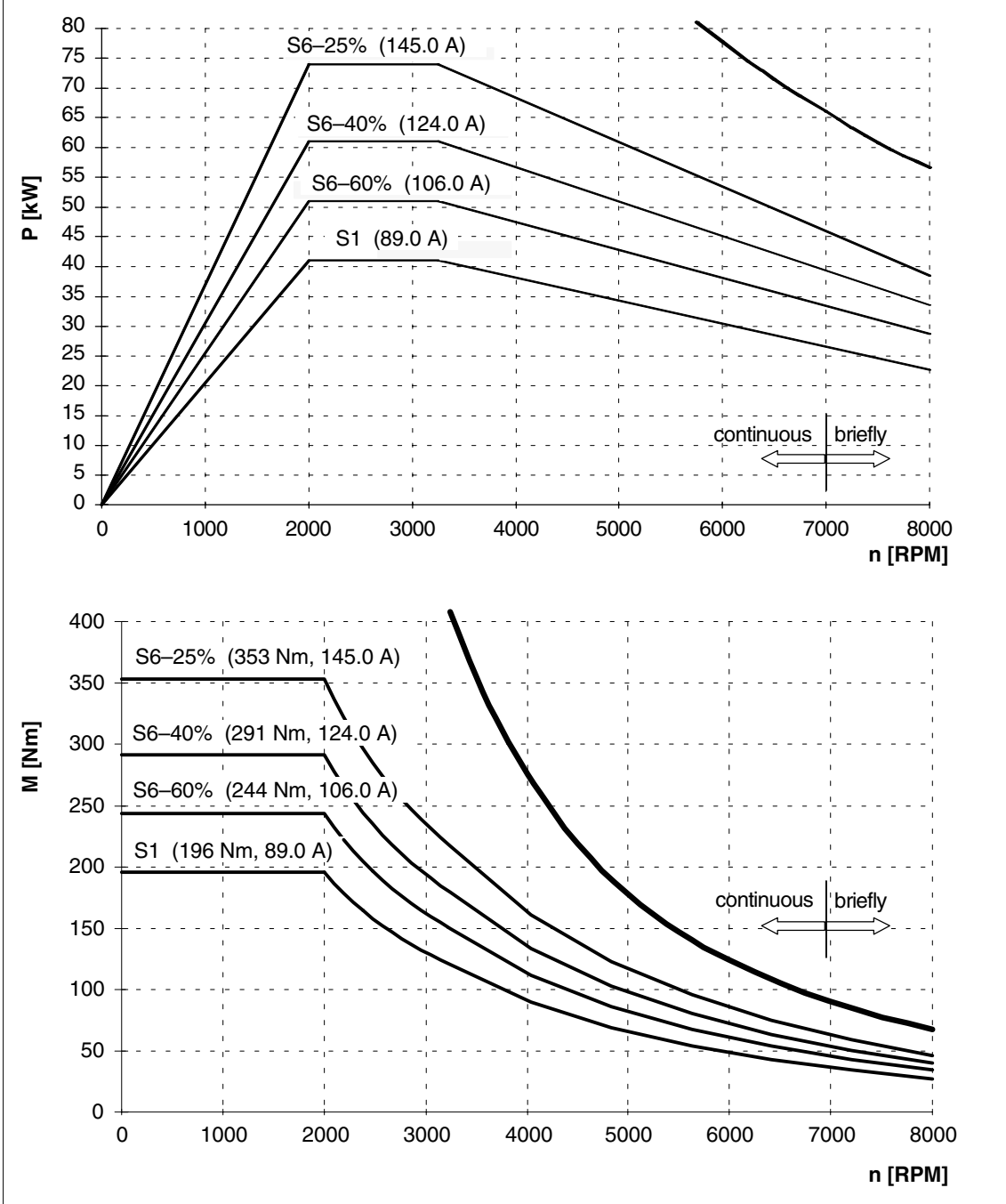

Fig. 2-48 1PH7167-□NG□□-0L

Table 2-52 Induction motor 1PH7184-□NT□□

P_N [kW]	n_N [RPM]	M_N [Nm]	I_N [A]	n_{max} [RPM]	T_{th} [min]	J [kgm ²]	m [kg]
21,5	500	411	76	5000 7000 ¹⁾	40	0.5	390

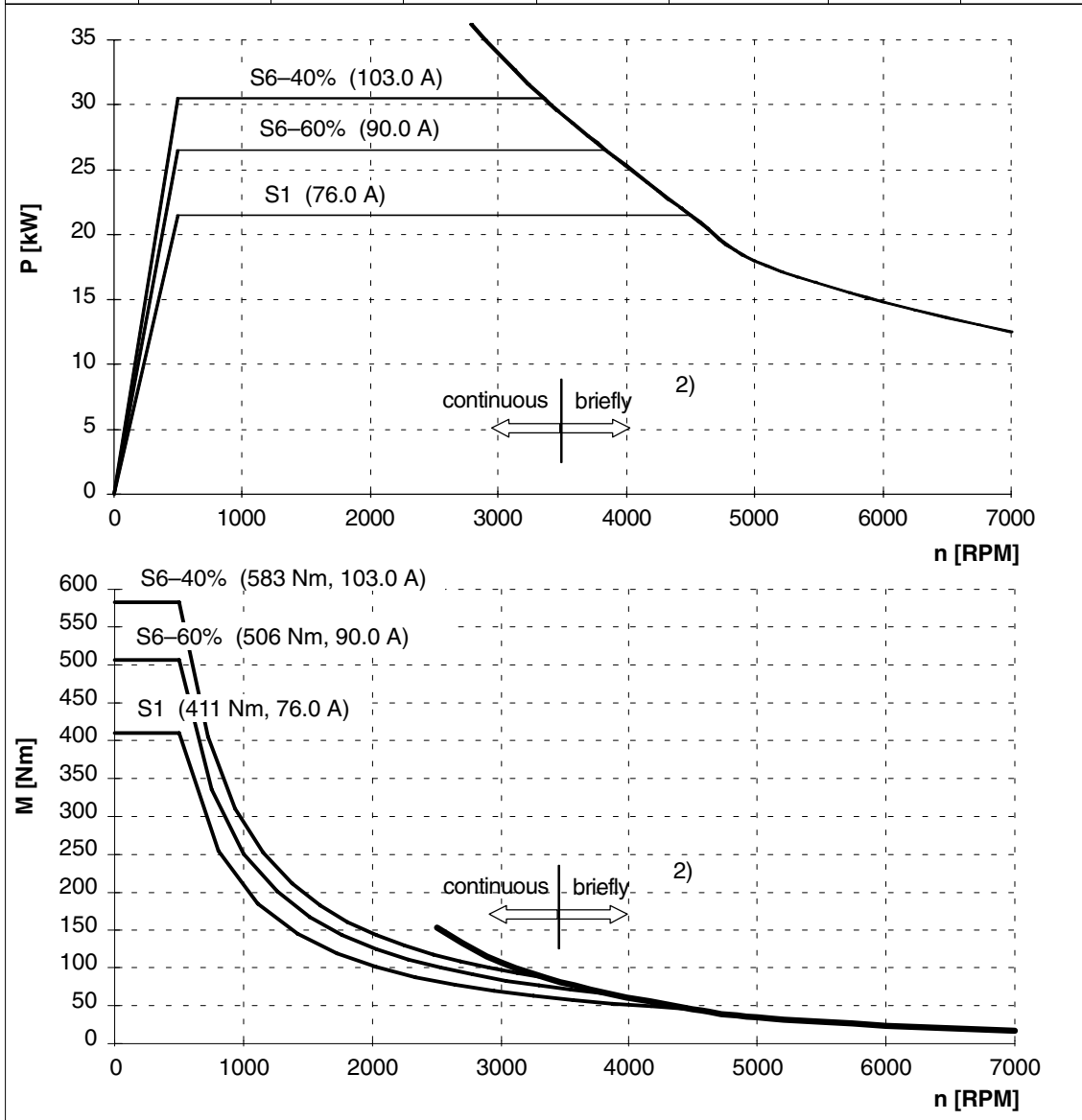

Fig. 2-49 1PH7184-□NT□□

- 1) Optional
- 2) This only applies for bearing versions for coupling/belt out-drive.
 For bearing versions designed for increased cantilever forces, this limit is at $n=3000$ RPM
 For bearing versions designed for increased maximum speeds, this limit is at $n=4500$ RPM

2.2 Power-speed and torque-speed diagrams

Table 2-53 Induction motor 1PH7184-□ND□□

P_N [kW]	n_N [RPM]	M_N [Nm]	I_N [A]	n_{max} [RPM]	T_{th} [min]	J [kgm ²]	m [kg]
39	1000	372	90	5000 7000 ¹⁾	40	0.5	390

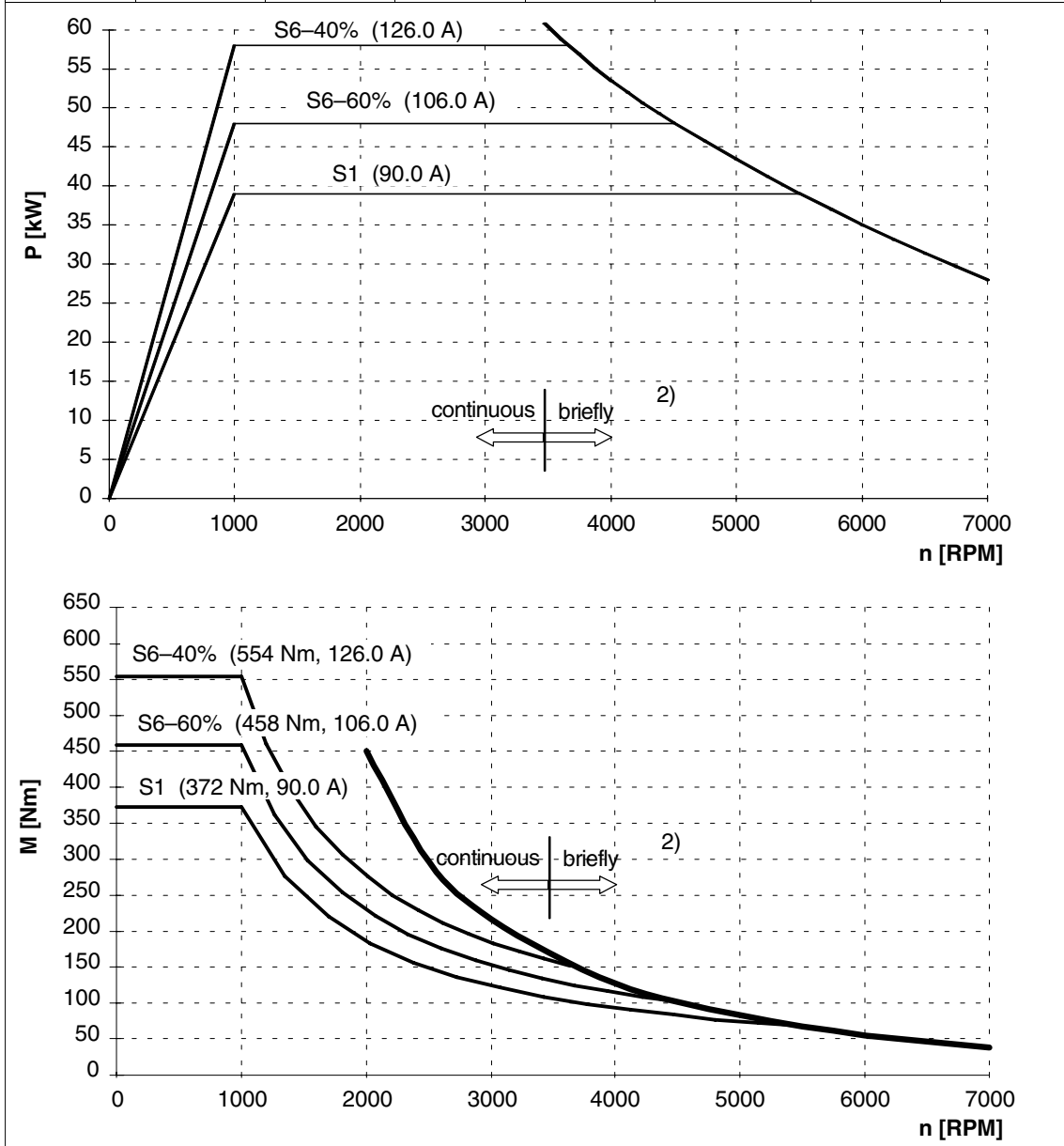

Fig. 2-50 1PH7184-□ND□□

1) Optional

2) This only applies for bearing versions for coupling/belt out-drive.

For bearing versions designed for increased cantilever forces, this limit is at $n=3000$ RPM

For bearing versions designed for increased maximum speeds, this limit is at $n=4500$ RPM

Table 2-54 Induction motor 1PH7184-□NE□□

P_N [kW]	n_N [RPM]	M_N [Nm]	I_N [A]	n_{max} [RPM]	T_{th} [min]	J [kgm ²]	m [kg]
40	1250	306	85	5000 7000 ¹⁾	40	0.5	390

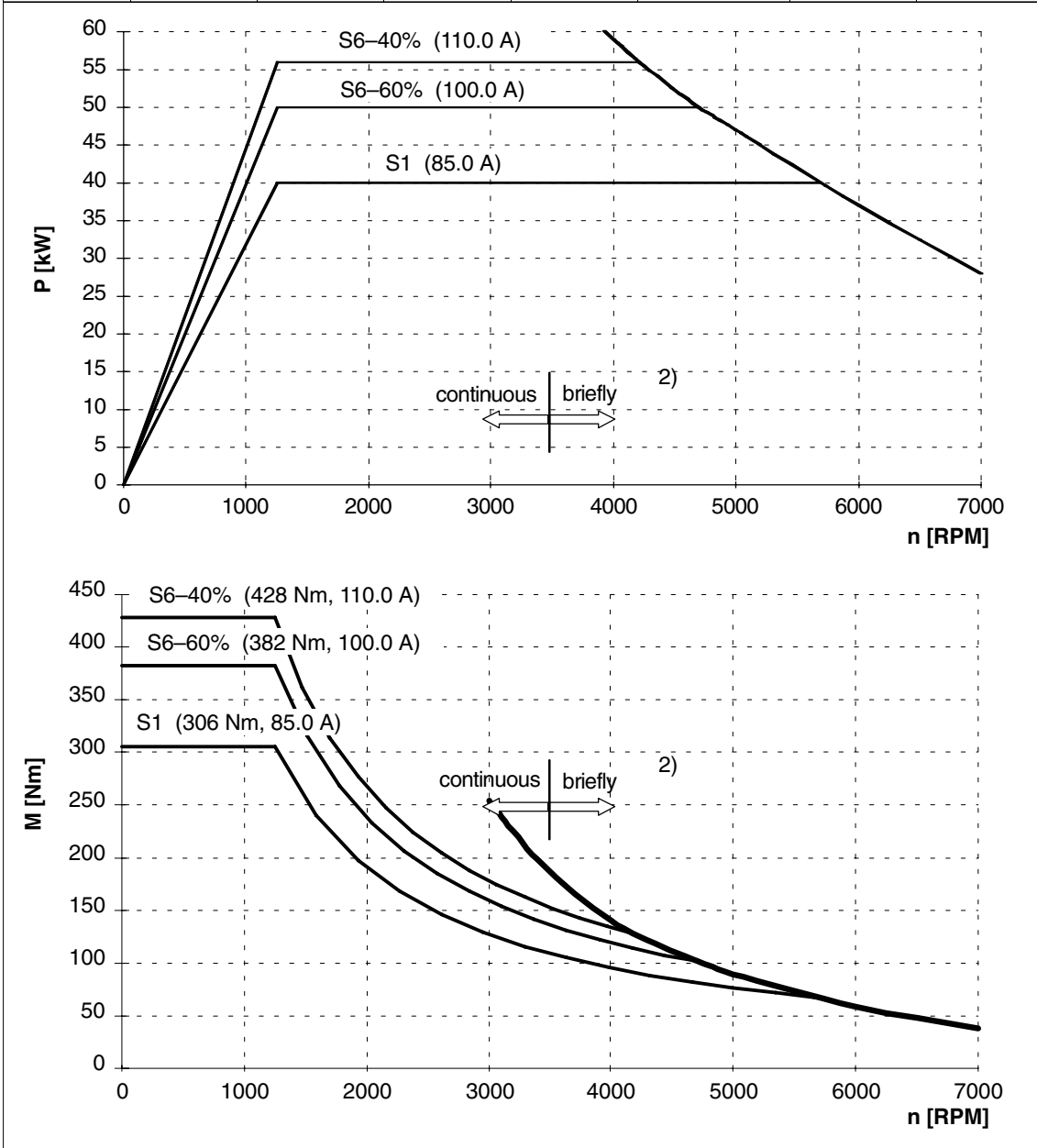

Fig. 2-51 1PH7184-□NE□□

- 1) Optional
- 2) This only applies for bearing versions for coupling/belt out-drive.
 For bearing versions designed for increased cantilever forces, this limit is at $n=3000$ RPM
 For bearing versions designed for increased maximum speeds, this limit is at $n=4500$ RPM

2.2 Power-speed and torque-speed diagrams

Table 2-55 Induction motor 1PH7184-□NF□□

P_N [kW]	n_N [RPM]	M_N [Nm]	I_N [A]	n_{max} [RPM]	T_{th} [min]	J [kgm ²]	m [kg]
51	1500	325	120	5000 7000 ¹⁾	40	0.5	390

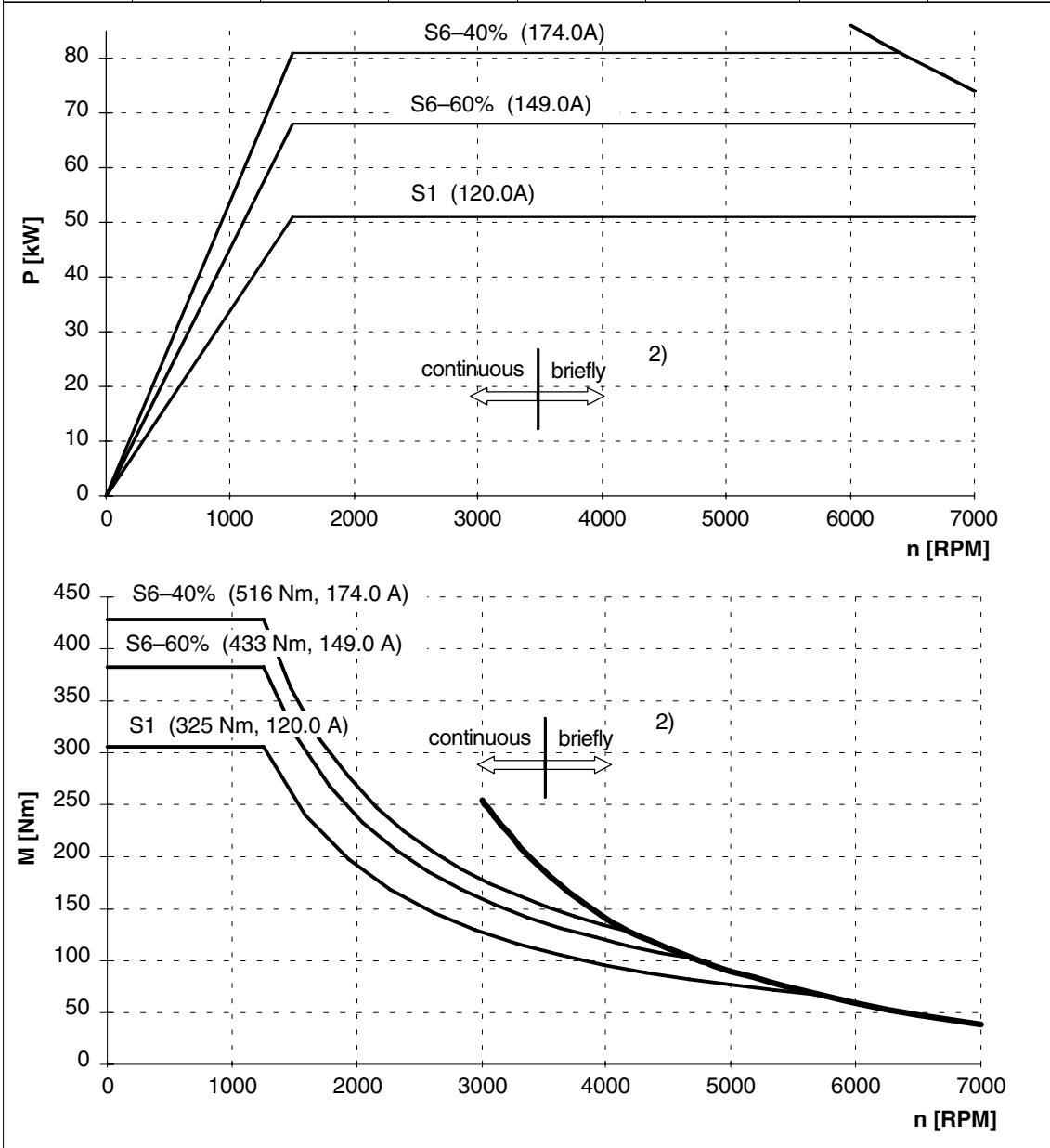

Fig. 2-52 1PH7184-□NF□□

1) Optional

2) This only applies for bearing versions for coupling/belt out-drive.
 For bearing versions designed for increased cantilever forces, this limit is at $n=3000$ RPM
 For bearing versions designed for increased maximum speeds, this limit is at $n=4500$ RPM

Table 2-56 Induction motor 1PH7184-□NL□□

P_N [kW]	n_N [RPM]	M_N [Nm]	I_N [A]	n_{max} [RPM]	T_{th} [min]	J [kgm ²]	m [kg]
78	2500	298	172	5000 7000 ¹⁾	40	0.5	390

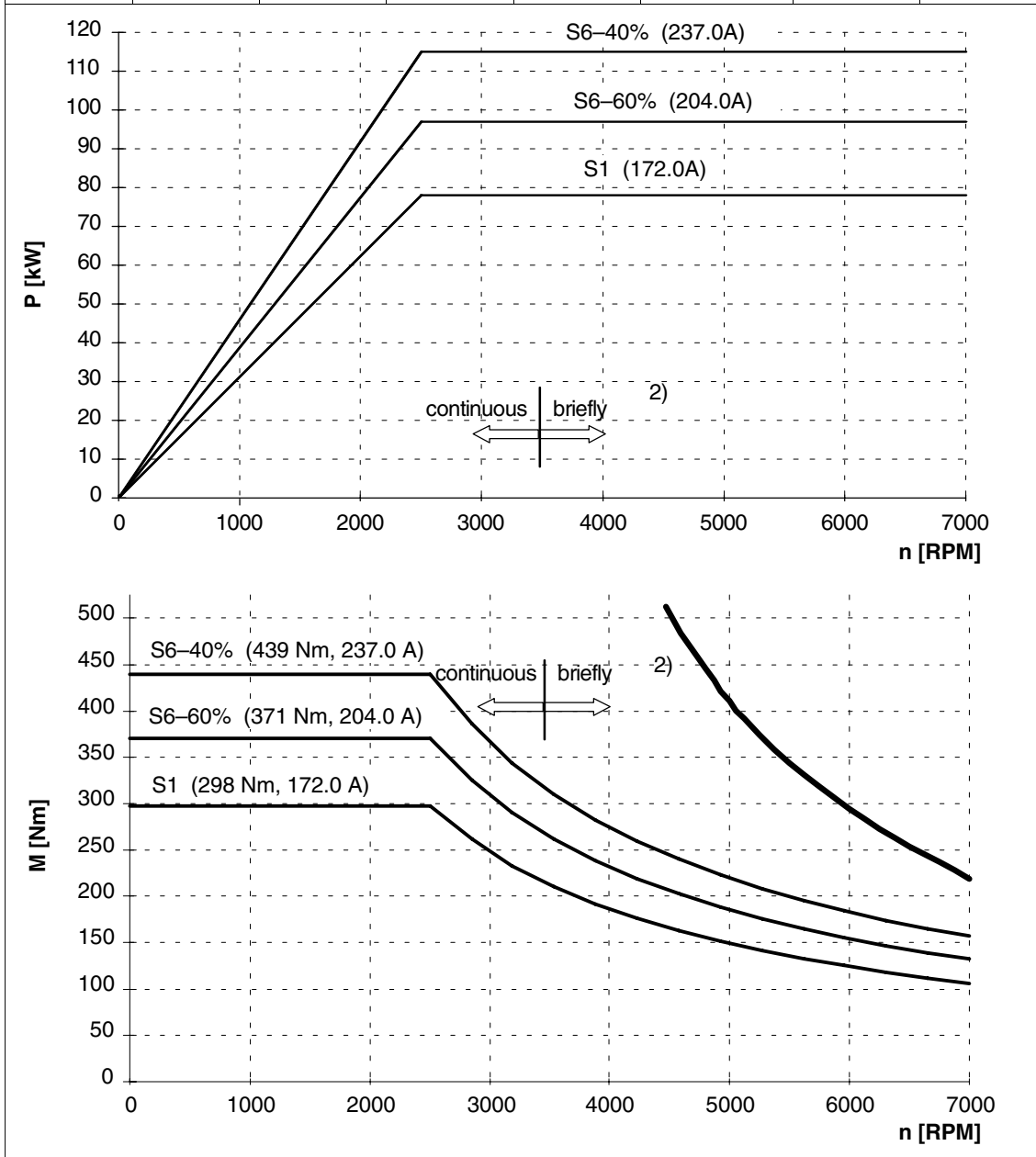

Fig. 2-53 1PH7184-□NL□□

1) Optional

2) This only applies for bearing versions for coupling/belt out-drive.

For bearing versions designed for increased cantilever forces, this limit is at $n=3000$ RPM

For bearing versions designed for increased maximum speeds, this limit is at $n=4500$ RPM

2.2 Power-speed and torque-speed diagrams

Table 2-57 Induction motor 1PH7186-□NT□□

P_N [kW]	n_N [RPM]	M_N [Nm]	I_N [A]	n_{max} [RPM]	T_{th} [min]	J [kgm ²]	m [kg]
29,6	500	565	106	5000 7000 ¹⁾	40	0.67	460

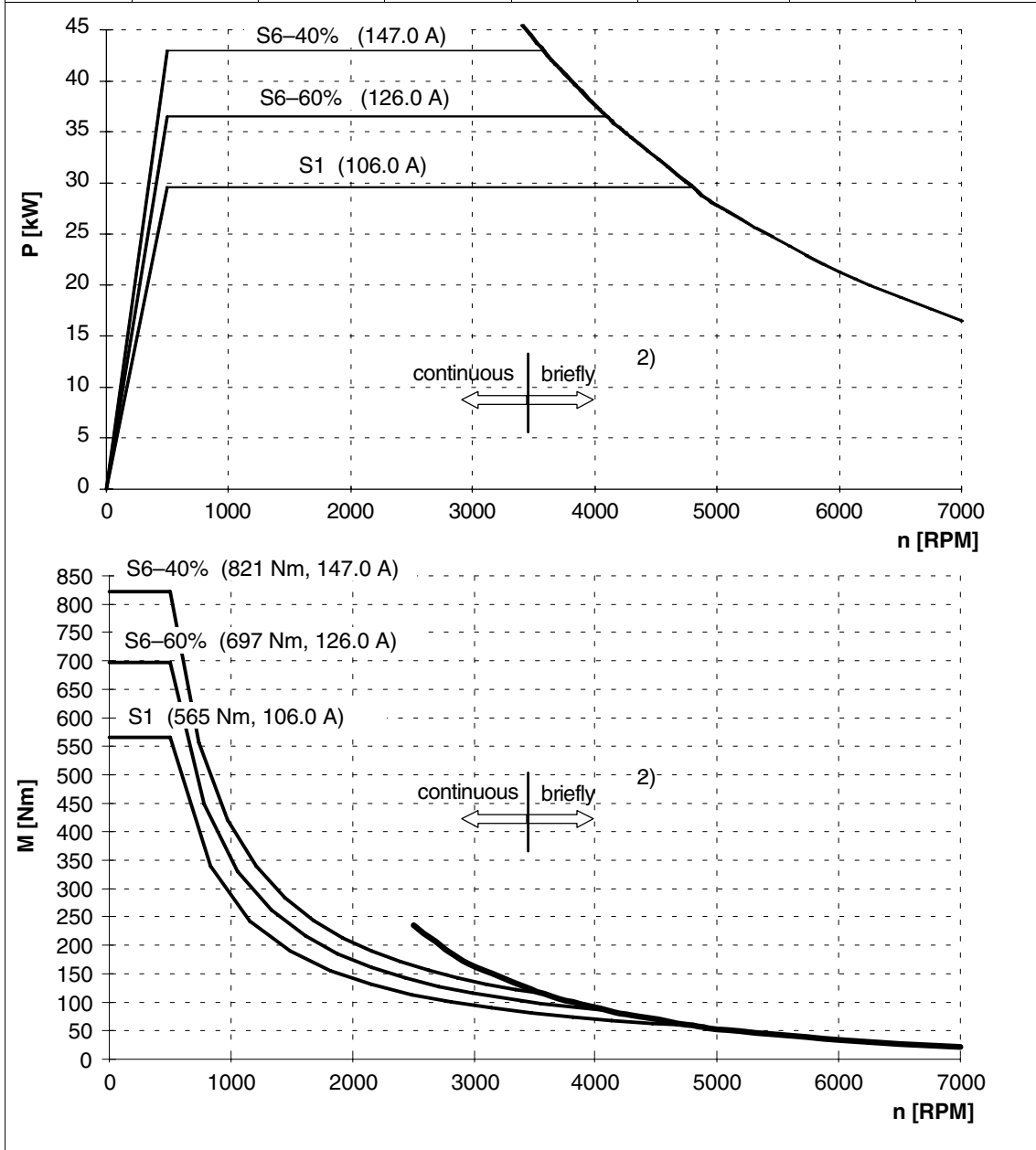

Fig. 2-54 1PH7186-□NT□□

1) Optional

2) This only applies for bearing versions for coupling/belt out-drive.

For bearing versions designed for increased cantilever forces, this limit is at $n=3000$ RPM

For bearing versions designed for increased maximum speeds, this limit is at $n=4500$ RPM

Table 2-58 Induction motor 1PH7186-□ND□□

P_N [kW]	n_N [RPM]	M_N [Nm]	I_N [A]	n_{max} [RPM]	T_{th} [min]	J [kgm ²]	m [kg]
51	1000	487	118	5000 7000 ¹⁾	40	0.67	460

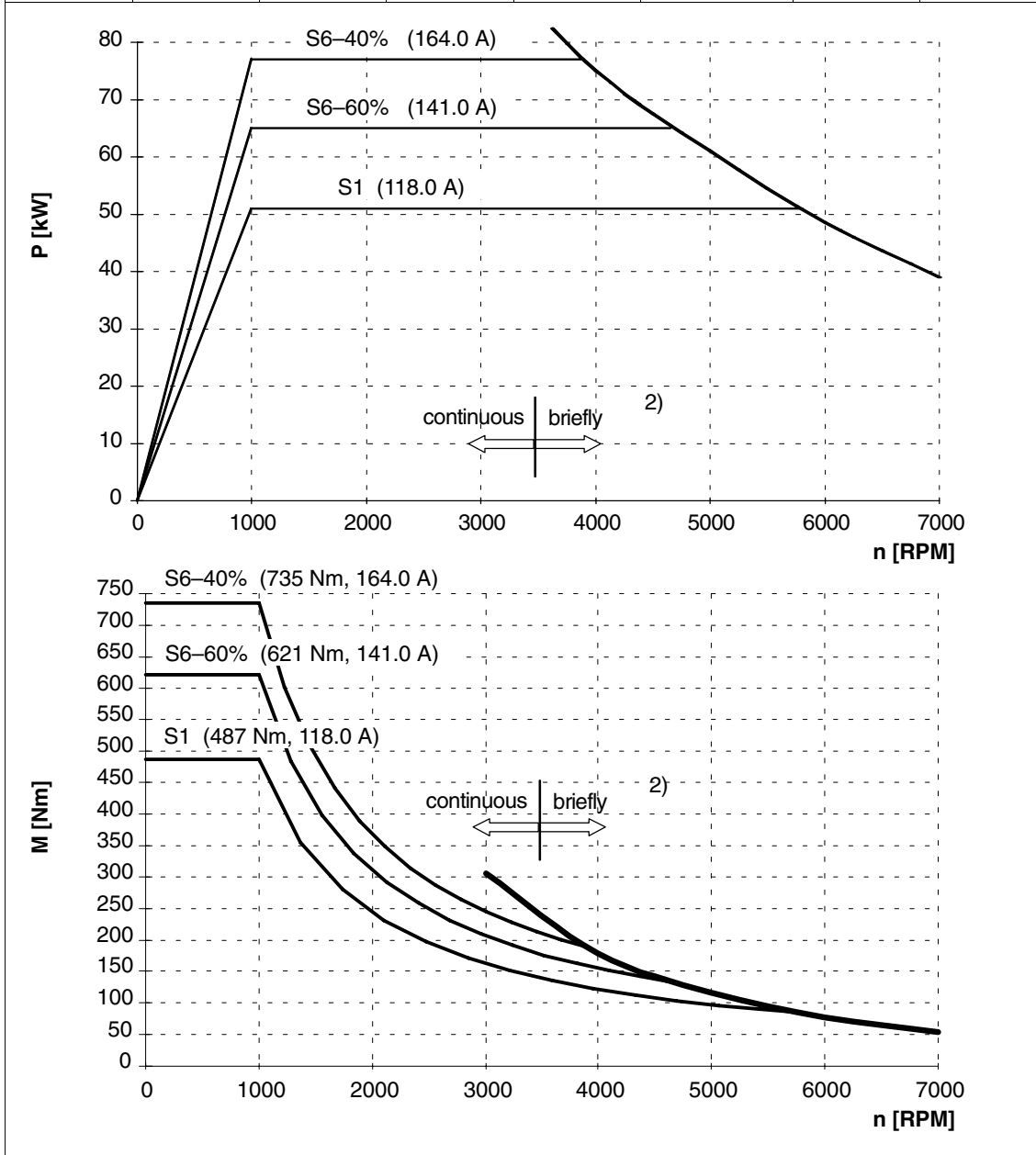

Fig. 2-55 1PH7186-□ND□□

1) Optional

2) This only applies for bearing versions for coupling/belt out-drive.

For bearing versions designed for increased cantilever forces, this limit is at $n=3000$ RPM

For bearing versions designed for increased maximum speeds, this limit is at $n=4500$ RPM

2.2 Power-speed and torque-speed diagrams

Table 2-59 Induction motor 1PH7186-□NE□□

P_N [kW]	n_N [RPM]	M_N [Nm]	I_N [A]	n_{max} [RPM]	T_{th} [min]	J [kgm ²]	m [kg]
60	1250	458	120	5000 7000 ¹⁾	40	0.67	460

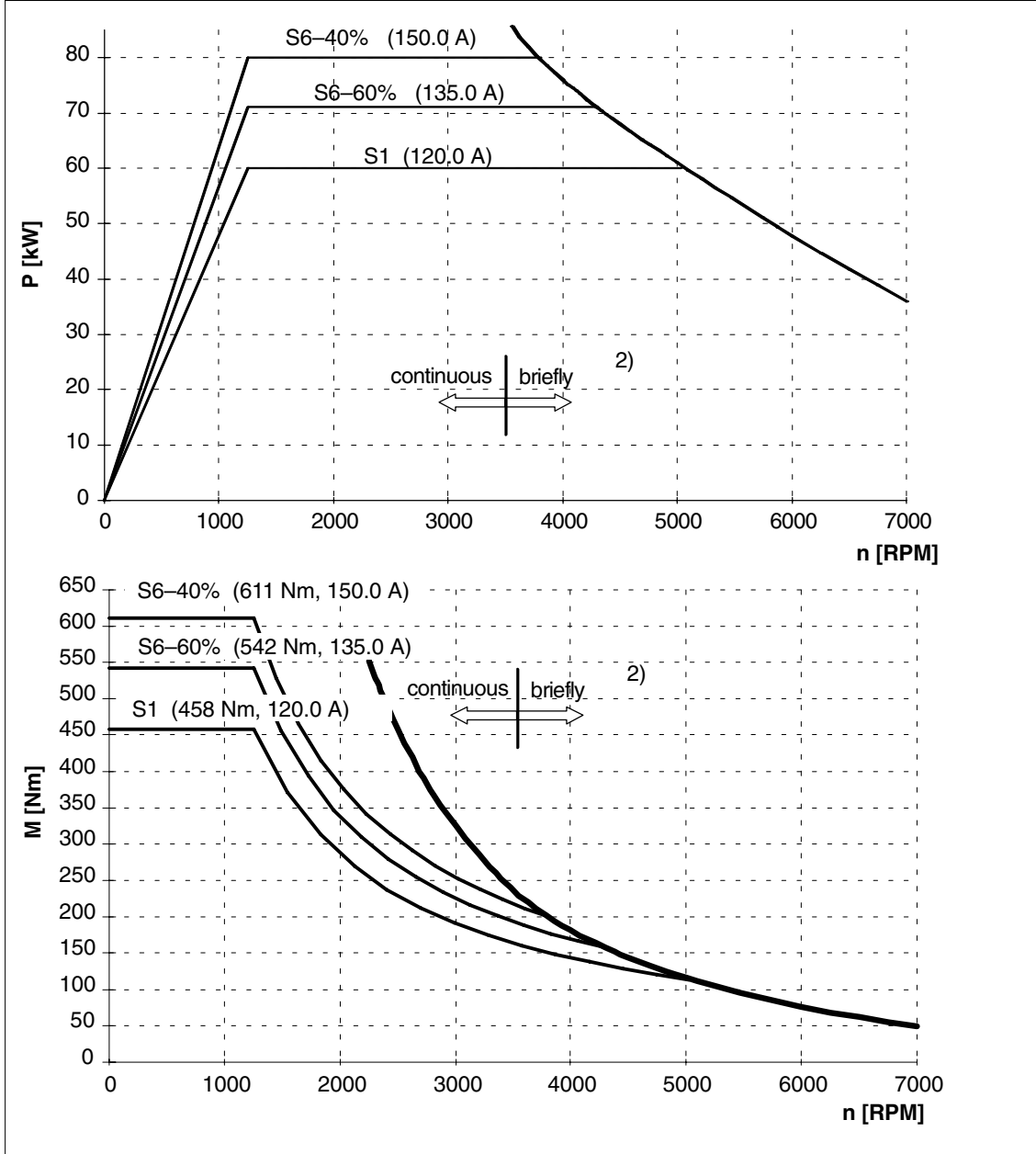

Fig. 2-56 1PH7186-□NE□□

1) Optional

2) This only applies for bearing versions for coupling/belt out-drive.
 For bearing versions designed for increased cantilever forces, this limit is at $n=3000$ RPM
 For bearing versions designed for increased maximum speeds, this limit is at $n=4500$ RPM

Table 2-60 Induction motor 1PH7224-□NC□□

P_N [kW]	n_N [RPM]	M_N [Nm]	I_N [A]	n_{max} [RPM]	T_{th} [min]	J [kgm ²]	m [kg]
55	700	750	117	4500 5500 ¹⁾	40	1.48	650

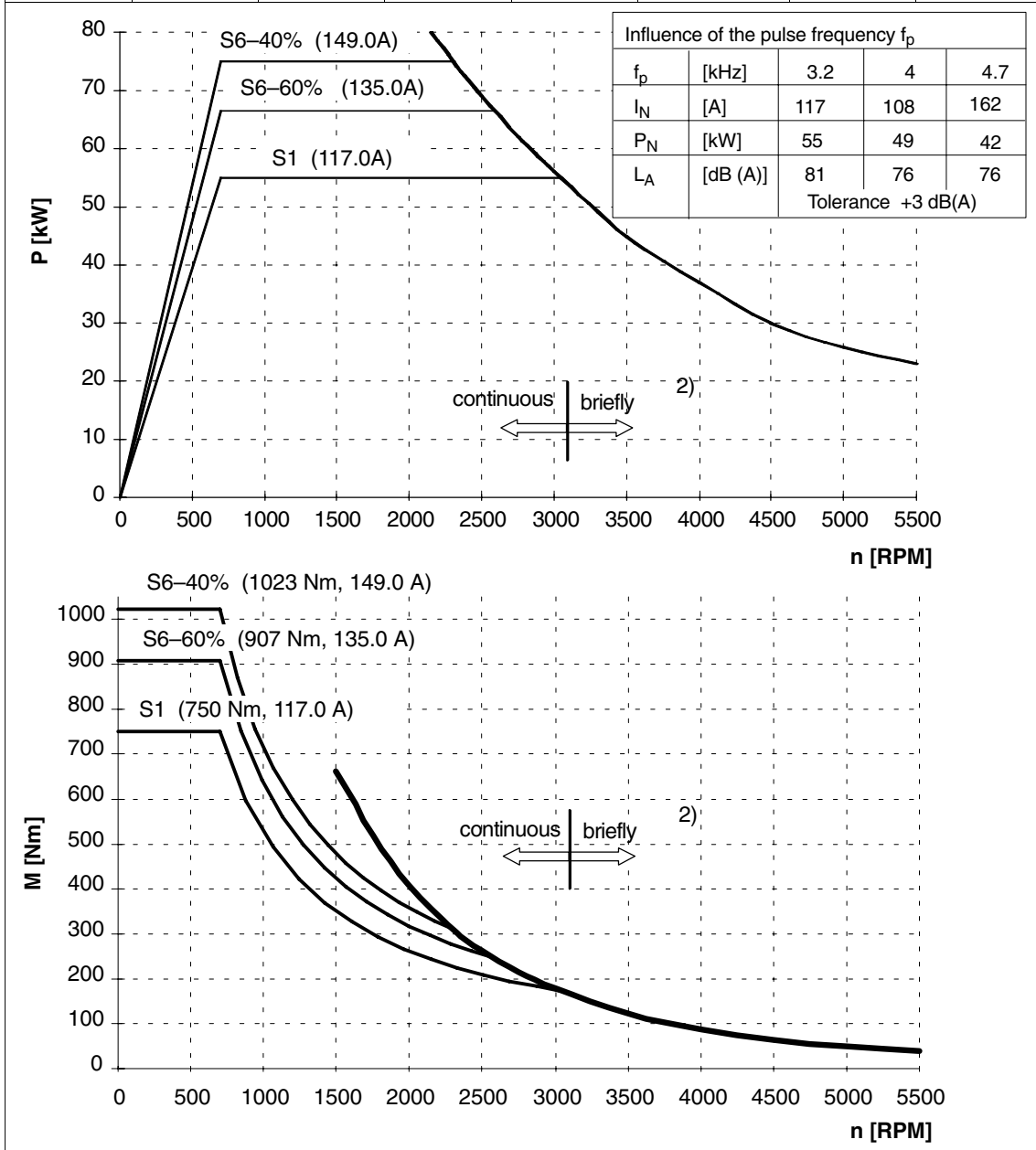

Fig. 2-57 1PH7224-□NC□□

1) Optional

2) This only applies for bearing versions for coupling/belt out-drive.

For bearing versions designed for increased cantilever forces, this limit is at $n=2700$ RPM

For bearing versions designed for increased maximum speeds, this limit is at $n=3600$ RPM

2.2 Power-speed and torque-speed diagrams

Table 2-61 Induction motor 1PH7224-□ND□□

P_N [kW]	n_N [RPM]	M_N [Nm]	I_N [A]	n_{max} [RPM]	T_{th} [min]	J [kgm ²]	m [kg]
71	1000	678	164	4500 5500 ¹⁾	40	1.48	650

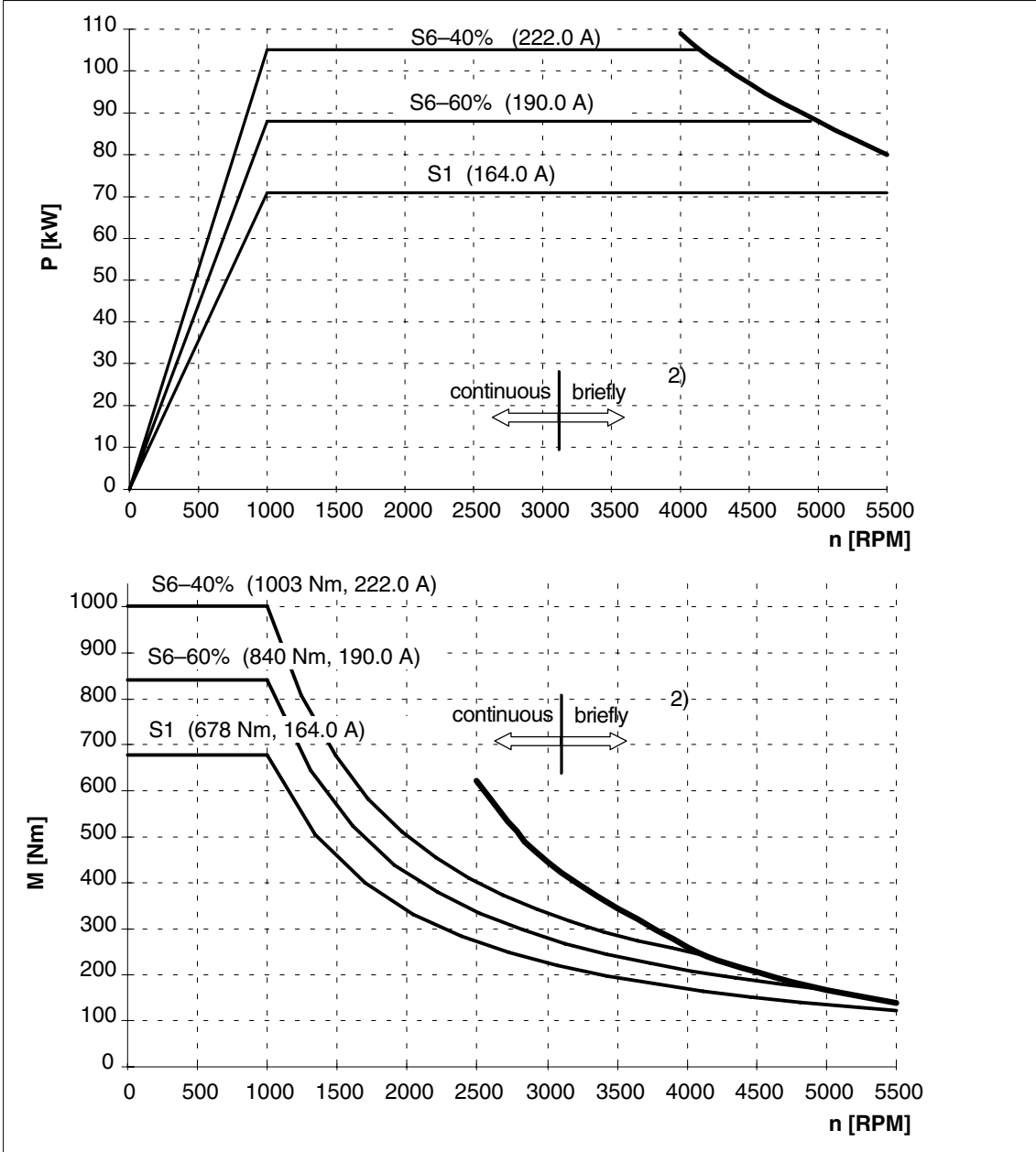

Fig. 2-58 1PH7224-□ND□□

1) Optional

2) This only applies for bearing versions for coupling/belt out-drive.
 For bearing versions designed for increased cantilever forces, this limit is at $n=2700$ RPM
 For bearing versions designed for increased maximum speeds, this limit is at $n=3600$ RPM

Table 2-62 Induction motor 1PH7224-□NF□□

P_N [kW]	n_N [RPM]	M_N [Nm]	I_N [A]	n_{max} [RPM]	T_{th} [min]	J [kgm ²]	m [kg]
100	1500	637	188	4500 5500 ¹⁾	40	1.48	650

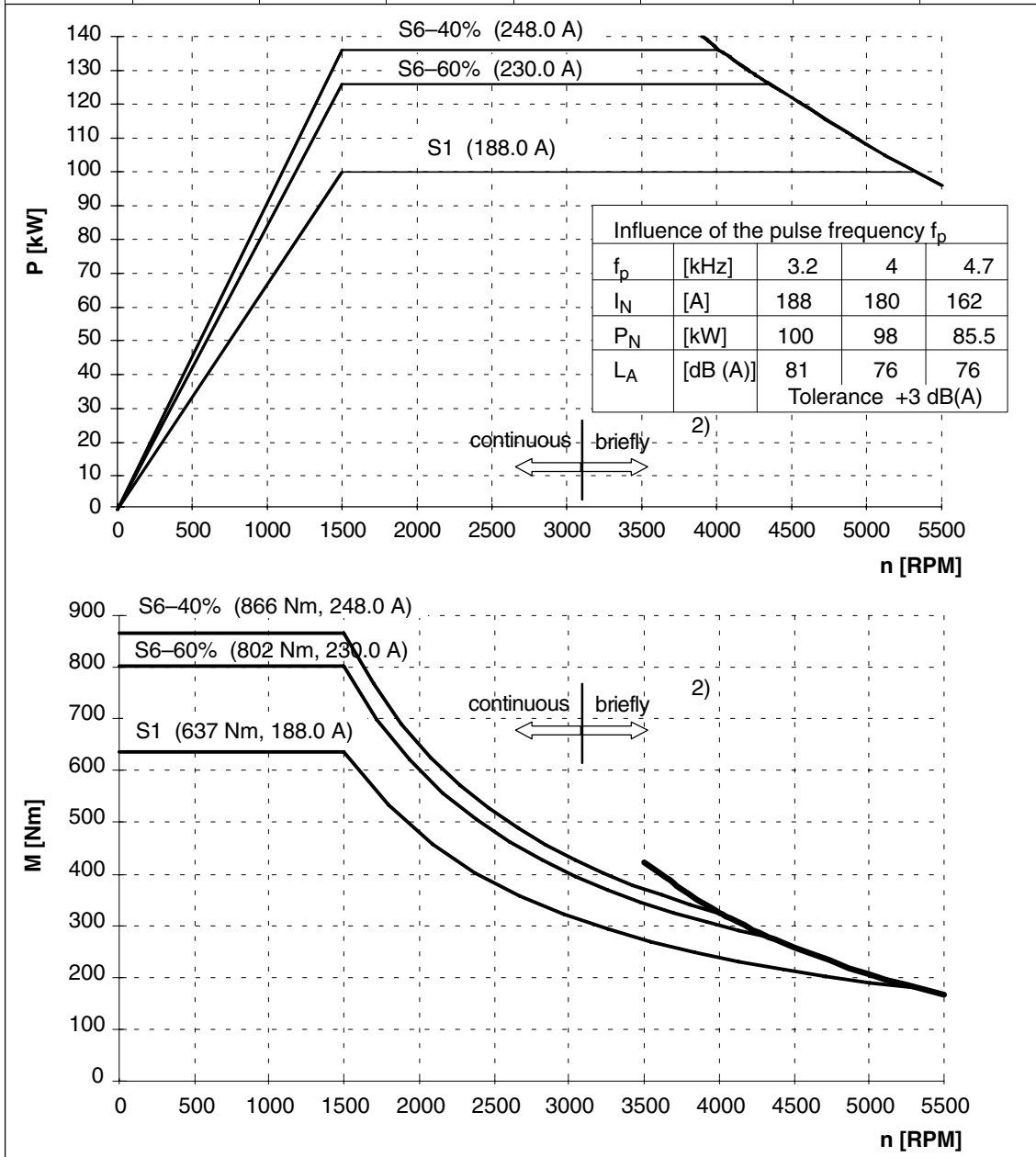

Fig. 2-59 1PH7224-□NF□□

1) Optional

2) This only applies for bearing versions for coupling/belt out-drive.

For bearing versions designed for increased cantilever forces, this limit is at $n=2700$ RPM

For bearing versions designed for increased maximum speeds, this limit is at $n=3600$ RPM

2.3 Cantilever and axial force diagrams

For a general description, please refer to the documentation “General Section for Induction Motors”.

2.3.1 Cantilever force



Caution

When using mechanical transmission elements, which subject the shaft end to a cantilever force, it should be ensured that the **maximum limit values, specified in the cantilever force diagrams, are not exceeded.**

Note

Shaft heights 180 and 225

For applications with an extremely low cantilever force load, it should be ensured that the motor shaft is subject to a **minimum cantilever force load as specified in the diagrams.** Lower cantilever forces can cause the cylindrical bearings to roll in an undefined fashion. This results in increased bearing wear and higher noise. For these applications, bearing designs for a coupling out-drive should be selected.

The maximum permissible and the minimum required cantilever forces are shown in the following diagrams.

SH 100, permissible cantilever forces for a standard bearing design

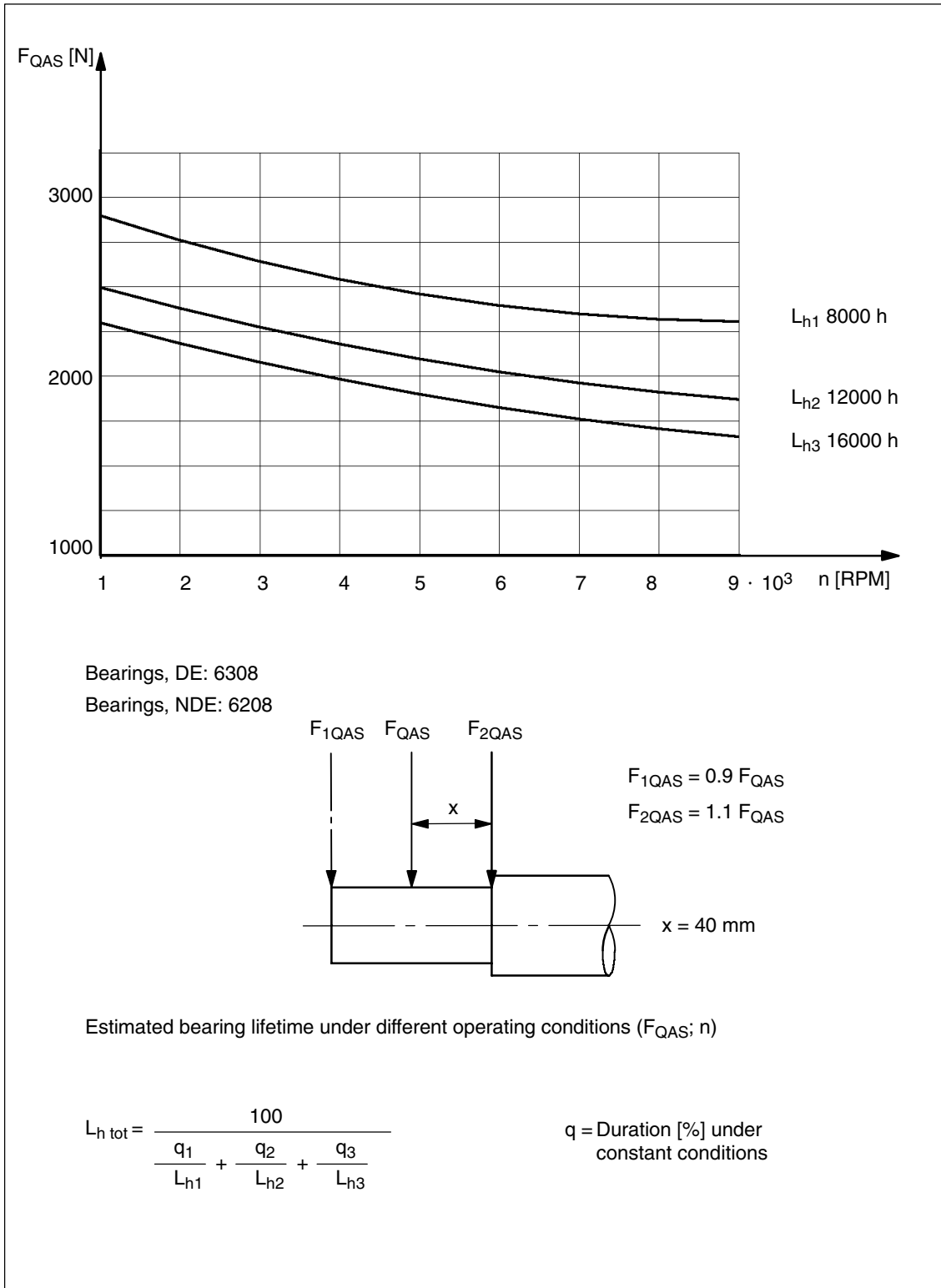

Fig. 2-60 Cantilever force diagram, shaft height 100 for standard bearing designs

SH 100, permissible cantilever forces for increased max. speed

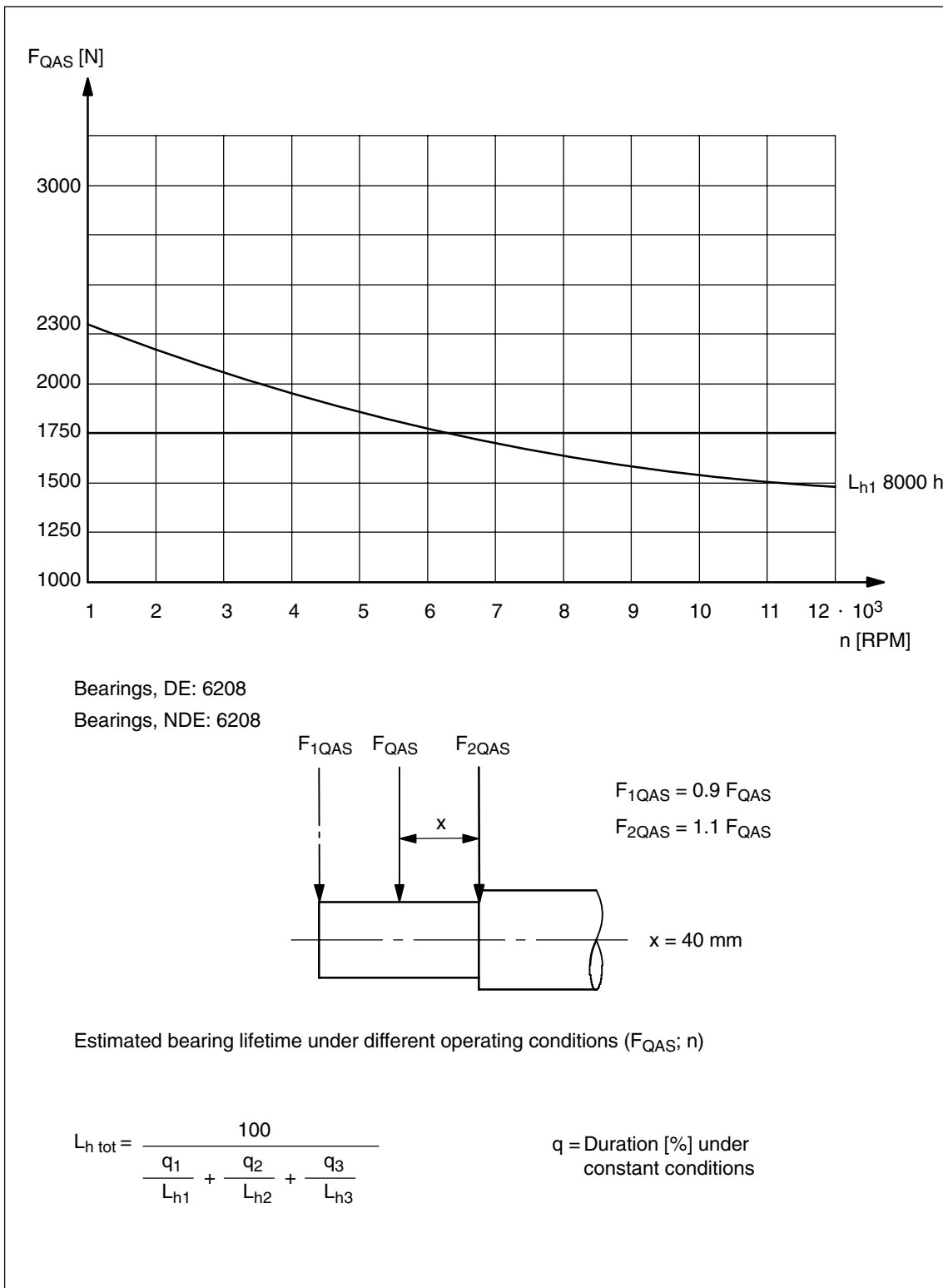

Fig. 2-61 Cantilever force diagram, shaft height 100 for increased max. speed

SH 132, permissible cantilever forces for a standard bearing design

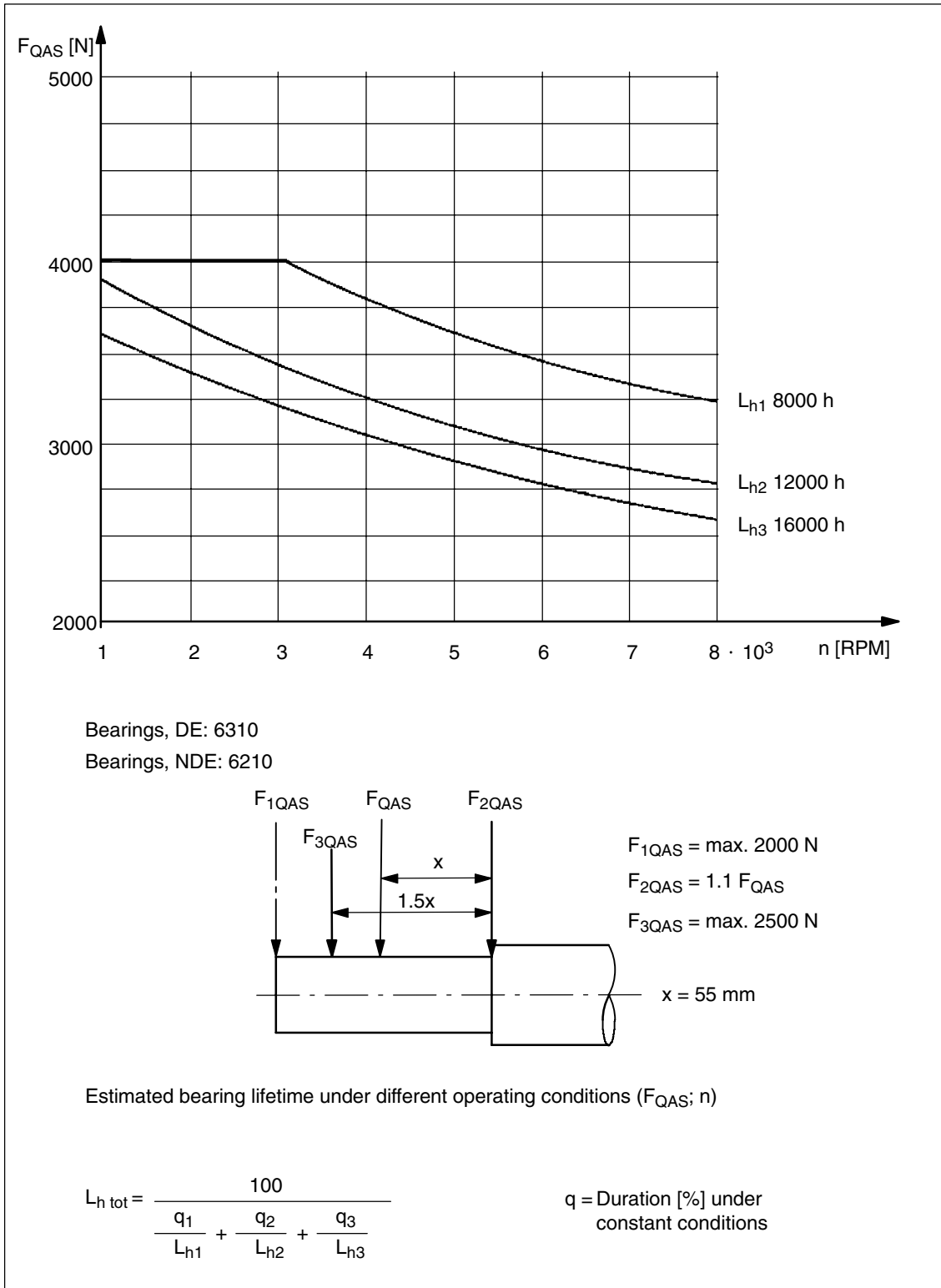

Fig. 2-62 Cantilever force diagram, shaft height 132 for standard bearing designs

SH 132, permissible cantilever forces for increased max. speed

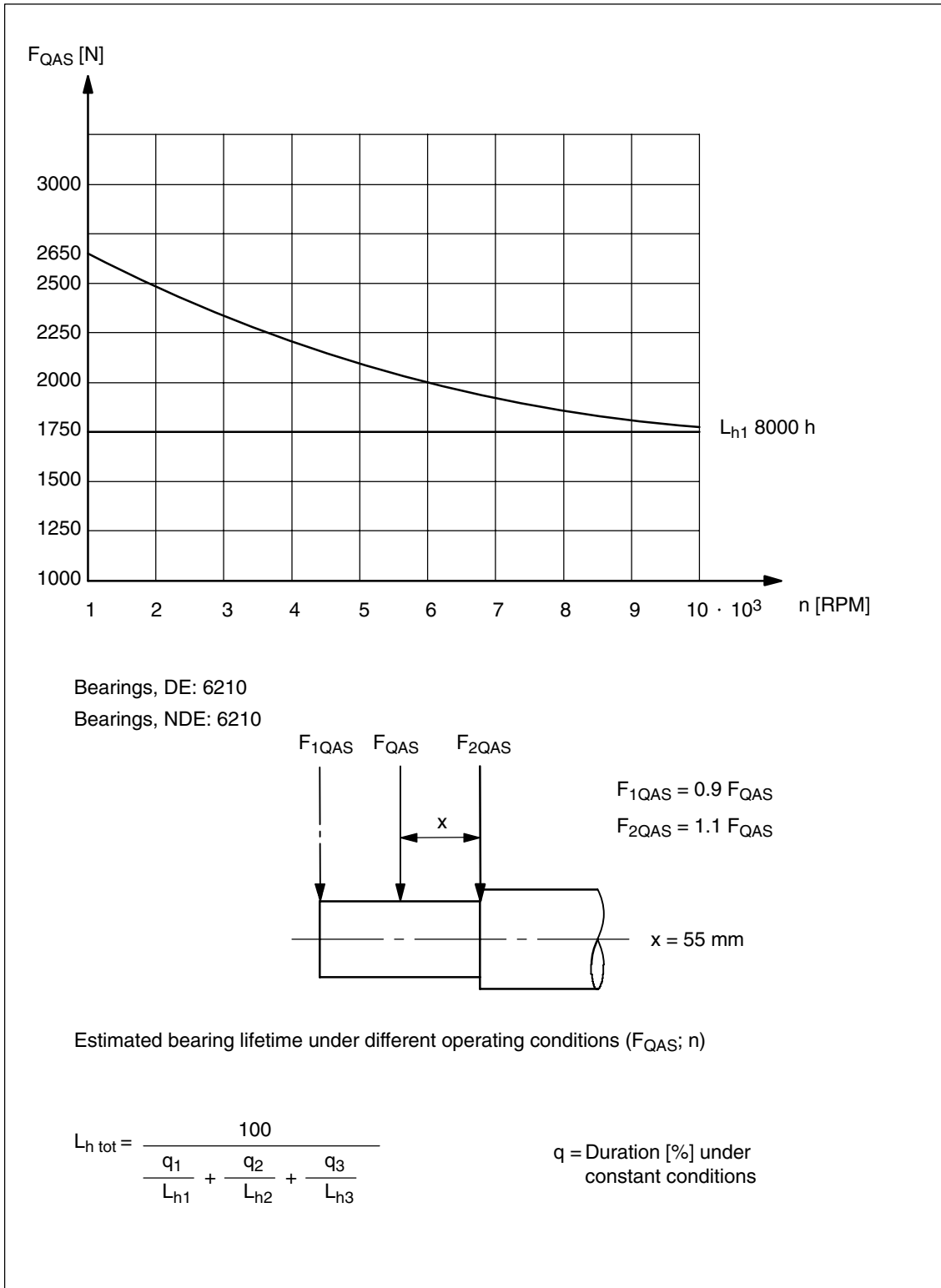

Fig. 2-63 Cantilever force diagram, shaft height 132 for increased max. speed

SH 160, permissible cantilever forces for a standard bearing design

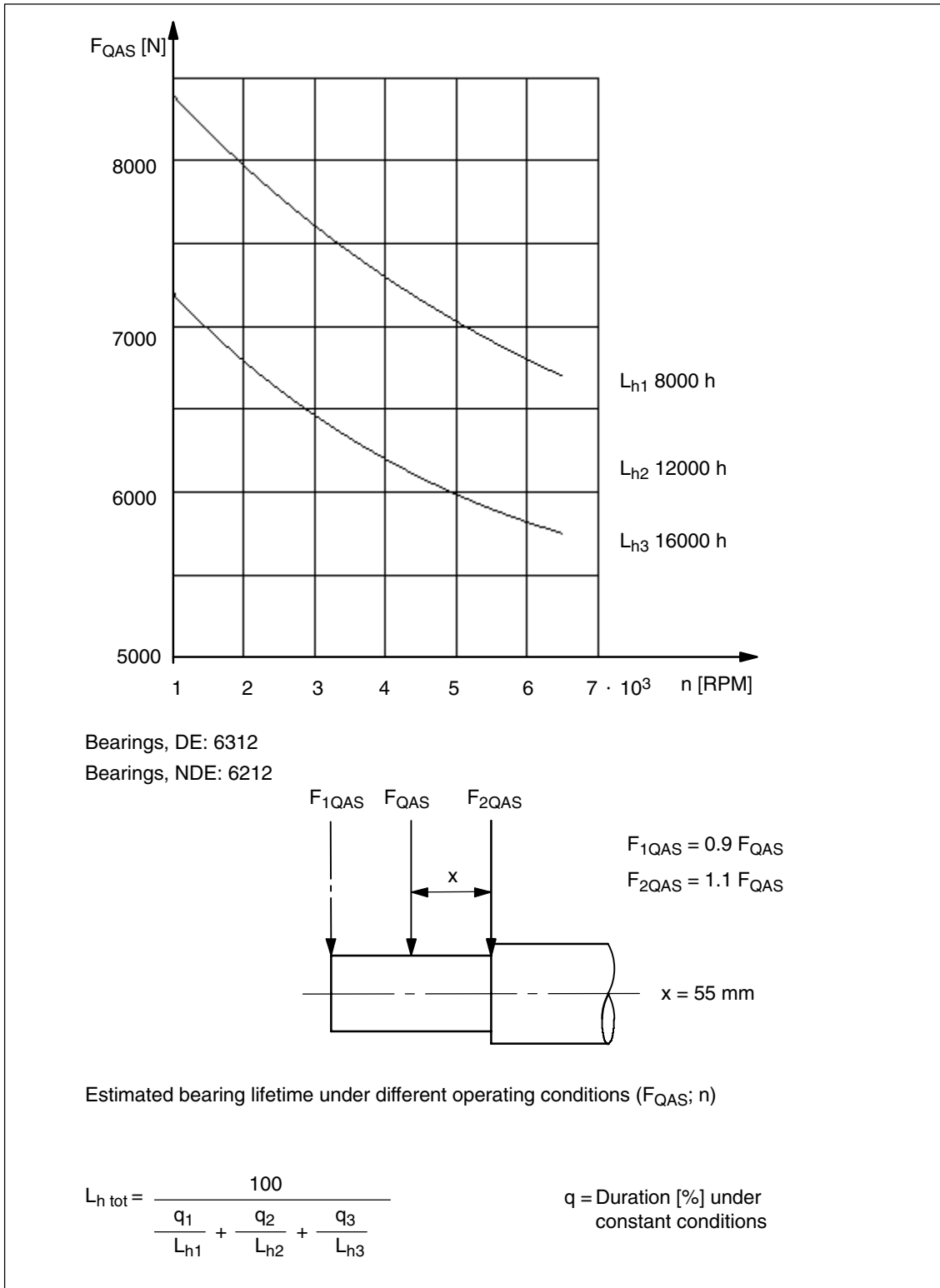

Fig. 2-64 Cantilever force diagram, shaft height 160 for standard bearing designs

SH 160, permissible cantilever forces for increased max. speed

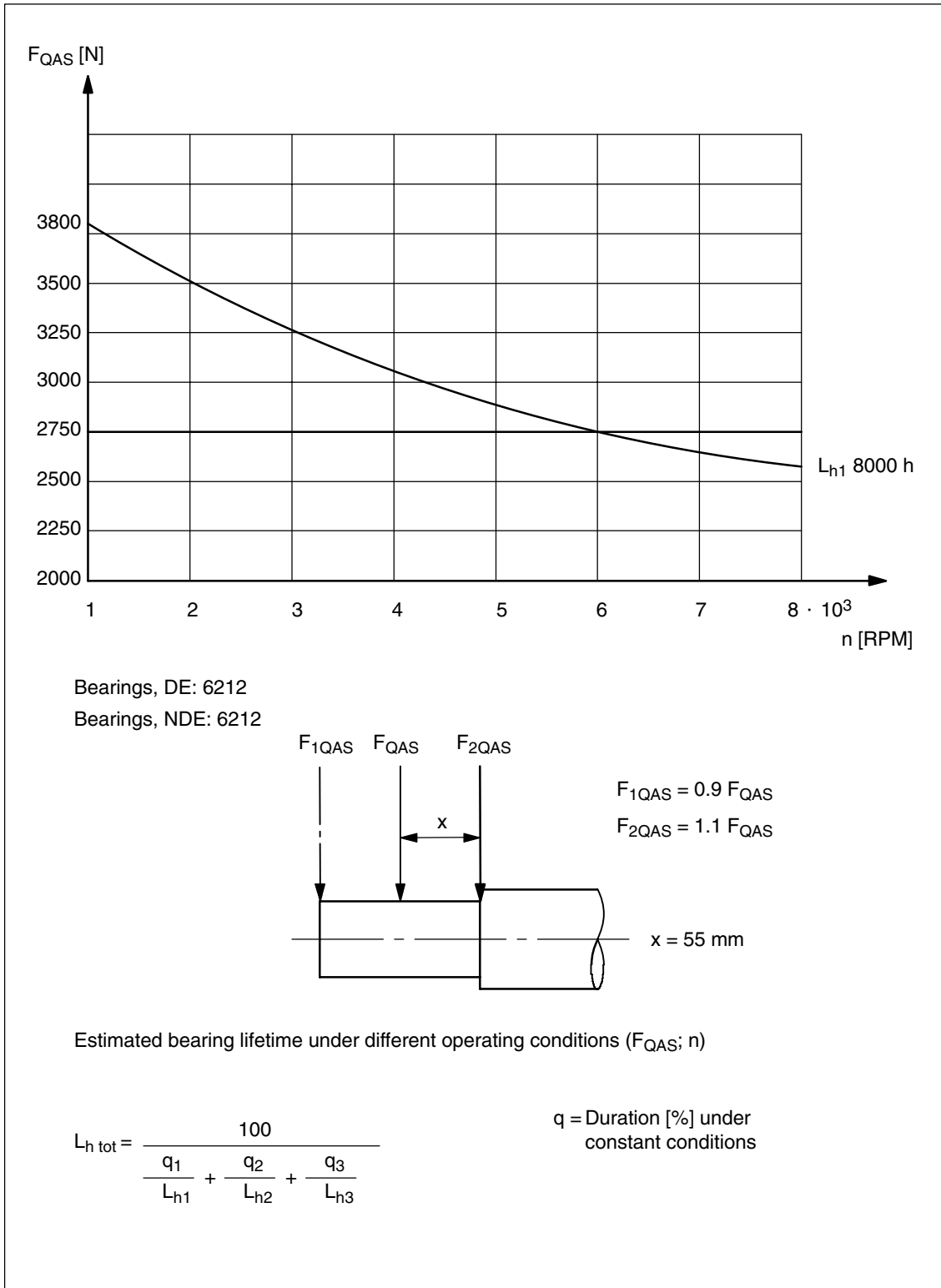

Fig. 2-65 Cantilever force diagram, shaft height 160 for increased max. speed

SH 180, permissible cantilever forces for a coupling out-drive

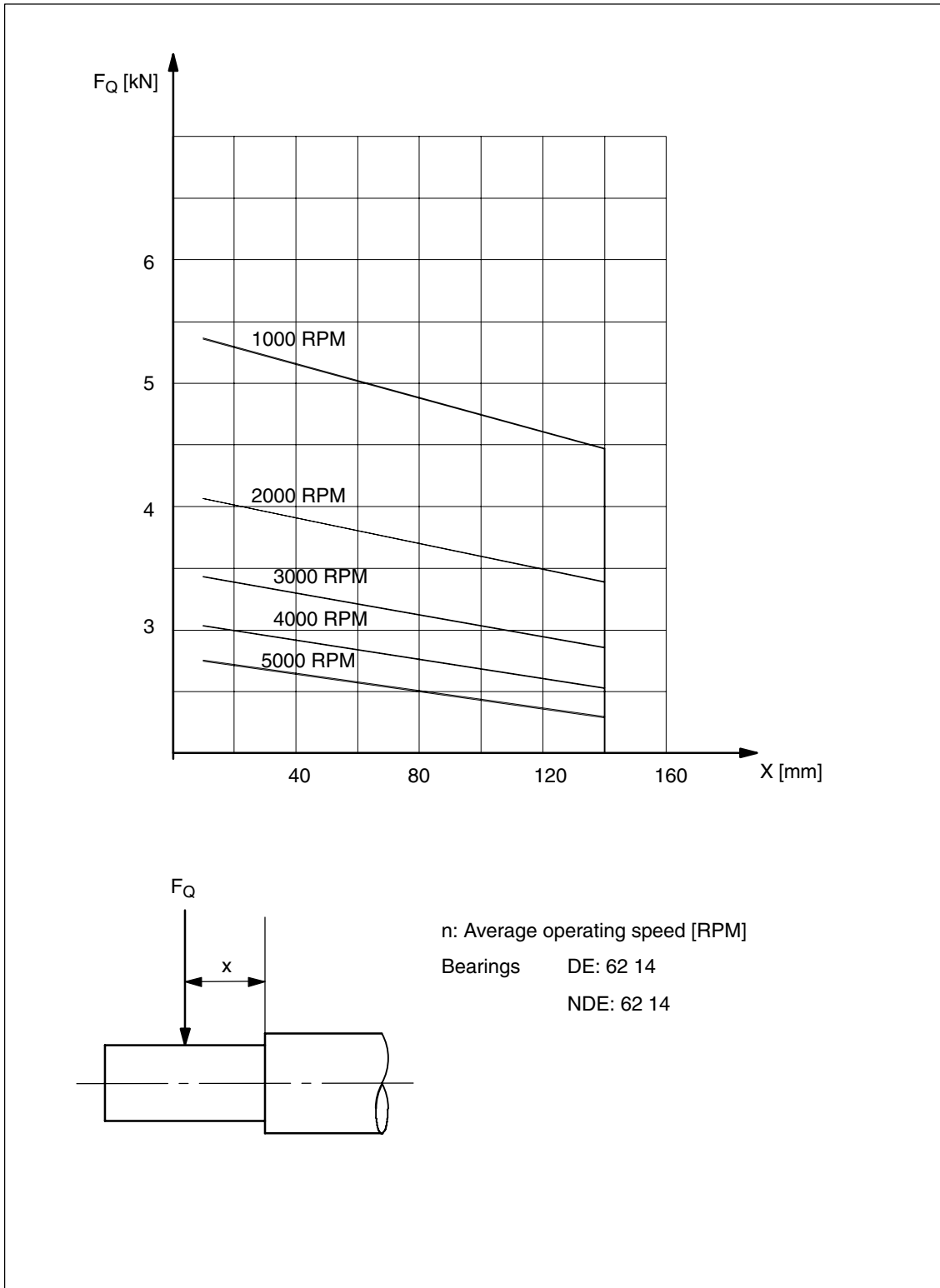

Fig. 2-66 Cantilever force diagram, shaft height 180 for coupling outdrive

SH 180, permissible cantilever forces for belt out-drives

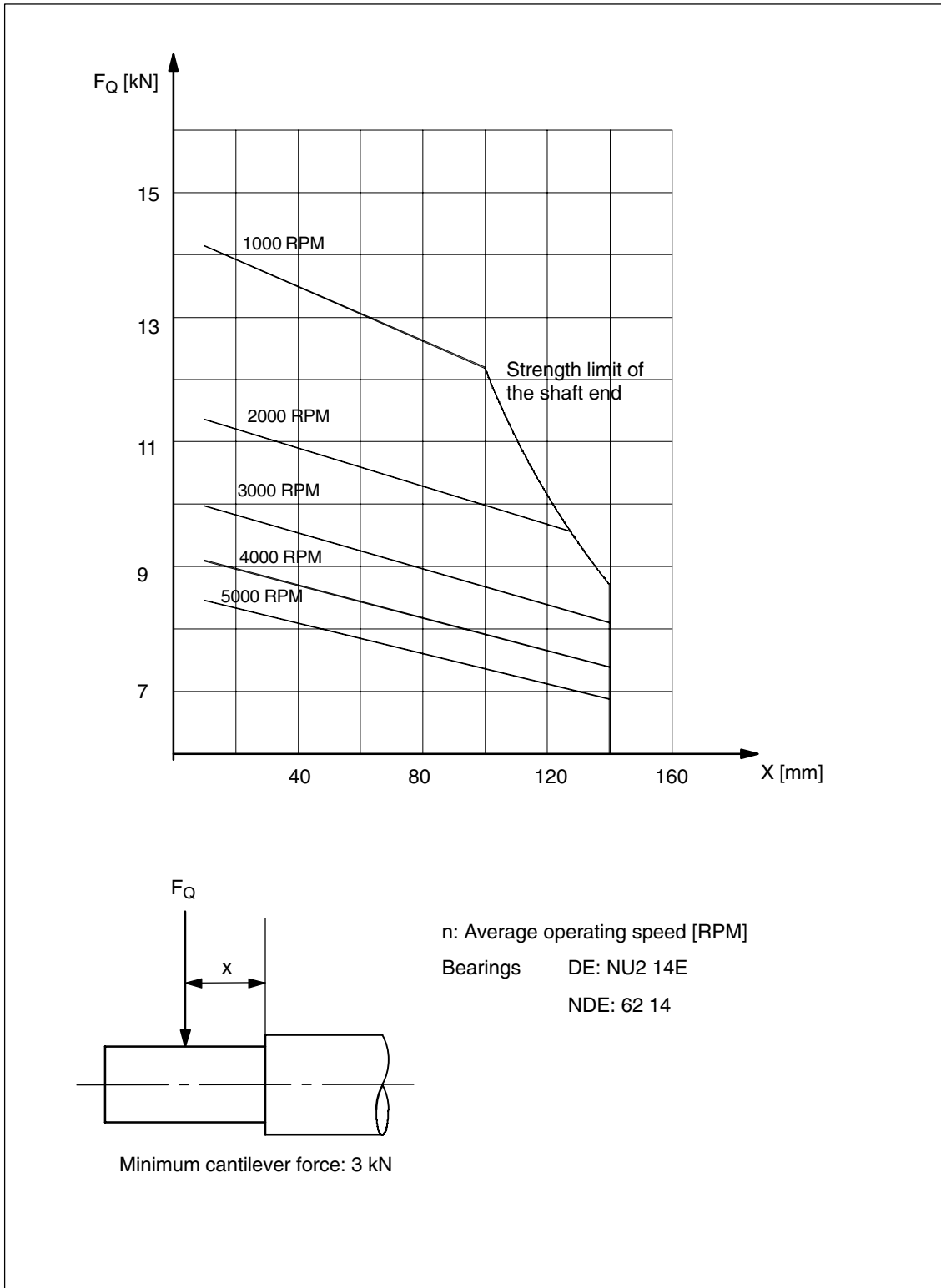

Fig. 2-67 Cantilever force diagram, shaft height 180 for belt out-drive

SH 180, permissible increased cantilever forces for belt out-drives

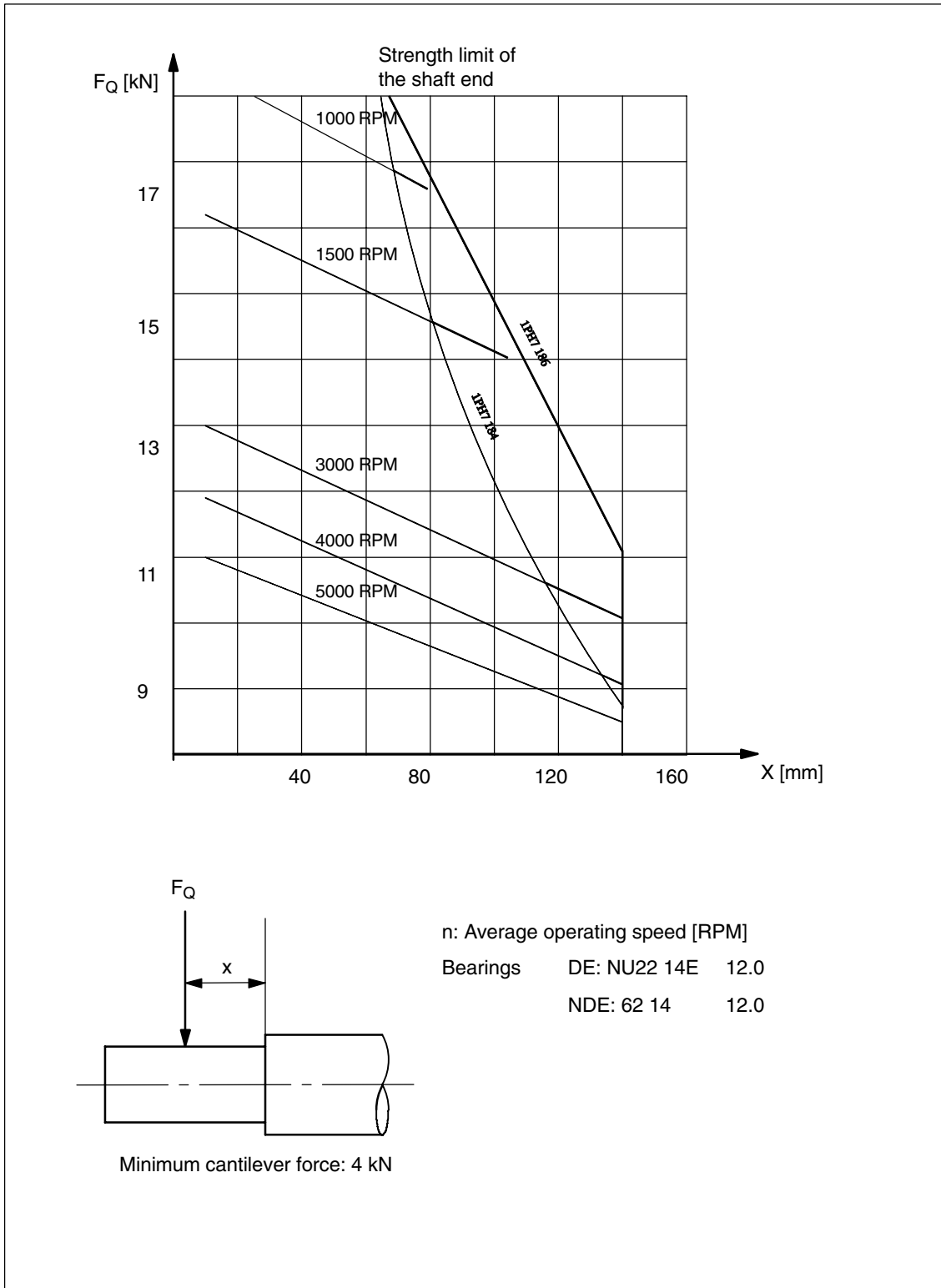

Fig. 2-68 Cantilever force diagram, shaft height 180 for belt out-drives (increased cantilever forces)

SH 225, permissible cantilever forces for a coupling out-drive

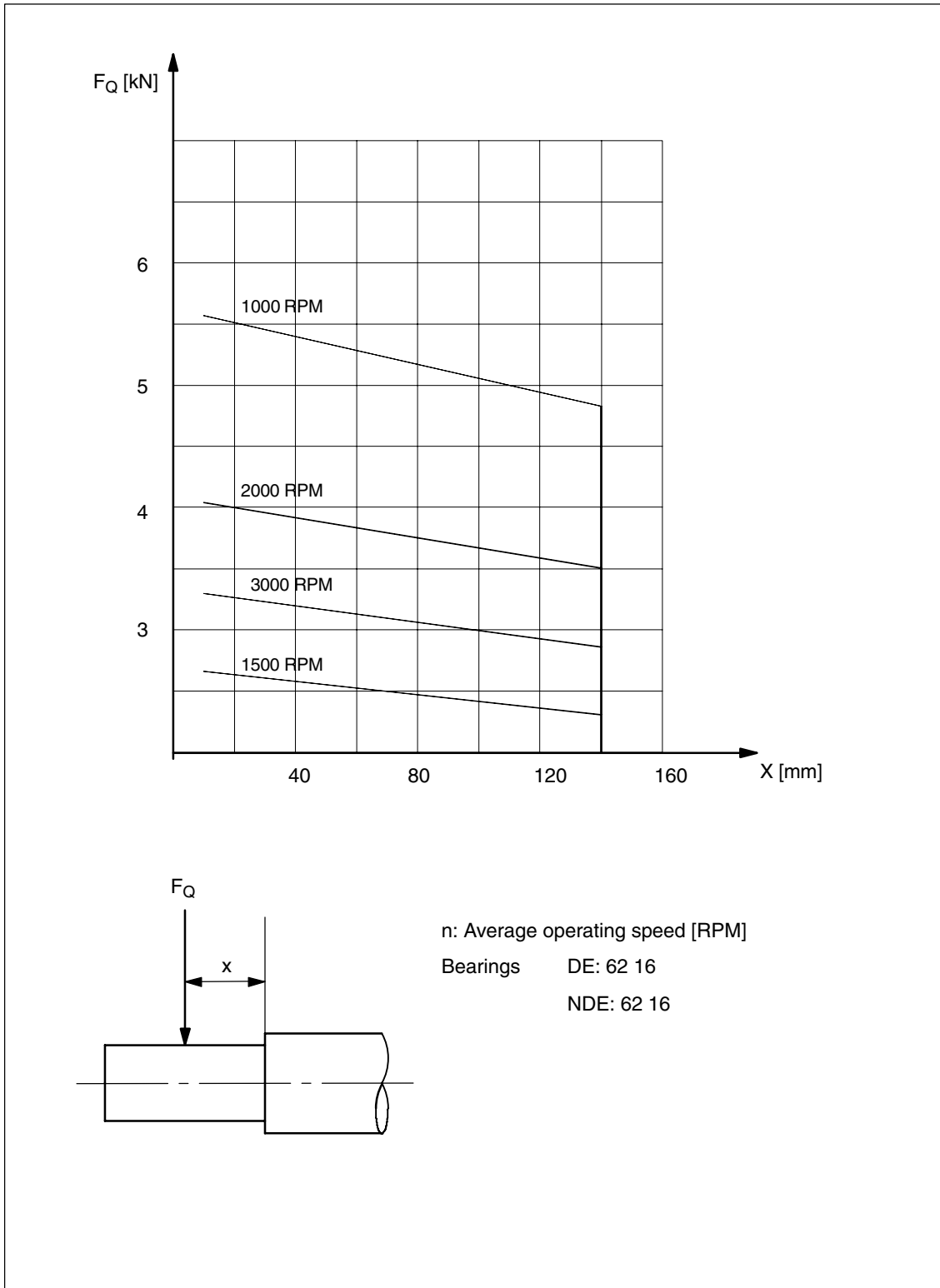

Fig. 2-69 Cantilever force diagram, shaft height 225 for coupling outdrive

SH 225, permissible cantilever forces for belt out-drives

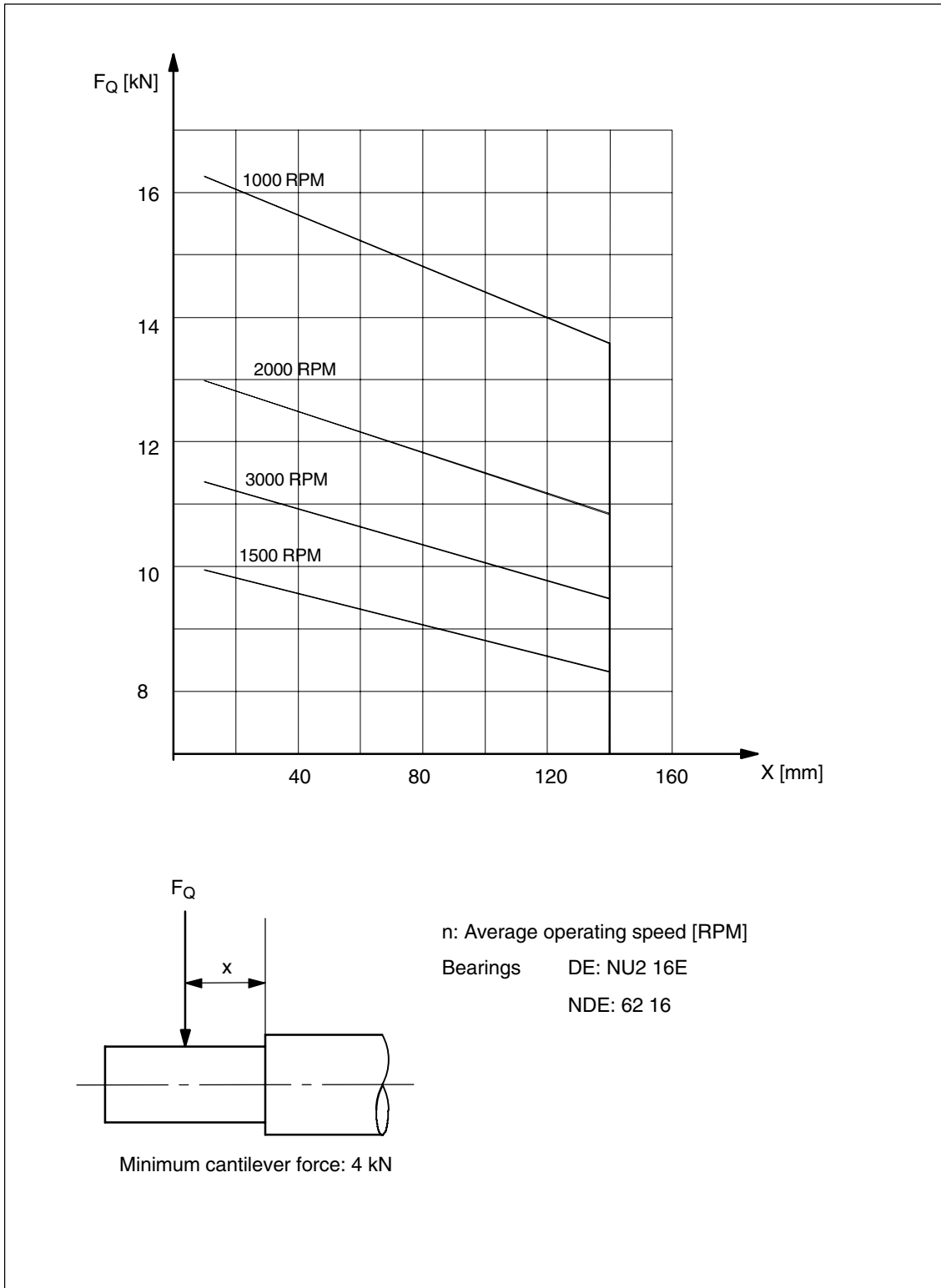

Fig. 2-70 Cantilever force diagram, shaft height 225 for belt out-drive

SH 225, permissible increased cantilever forces for belt out-drives

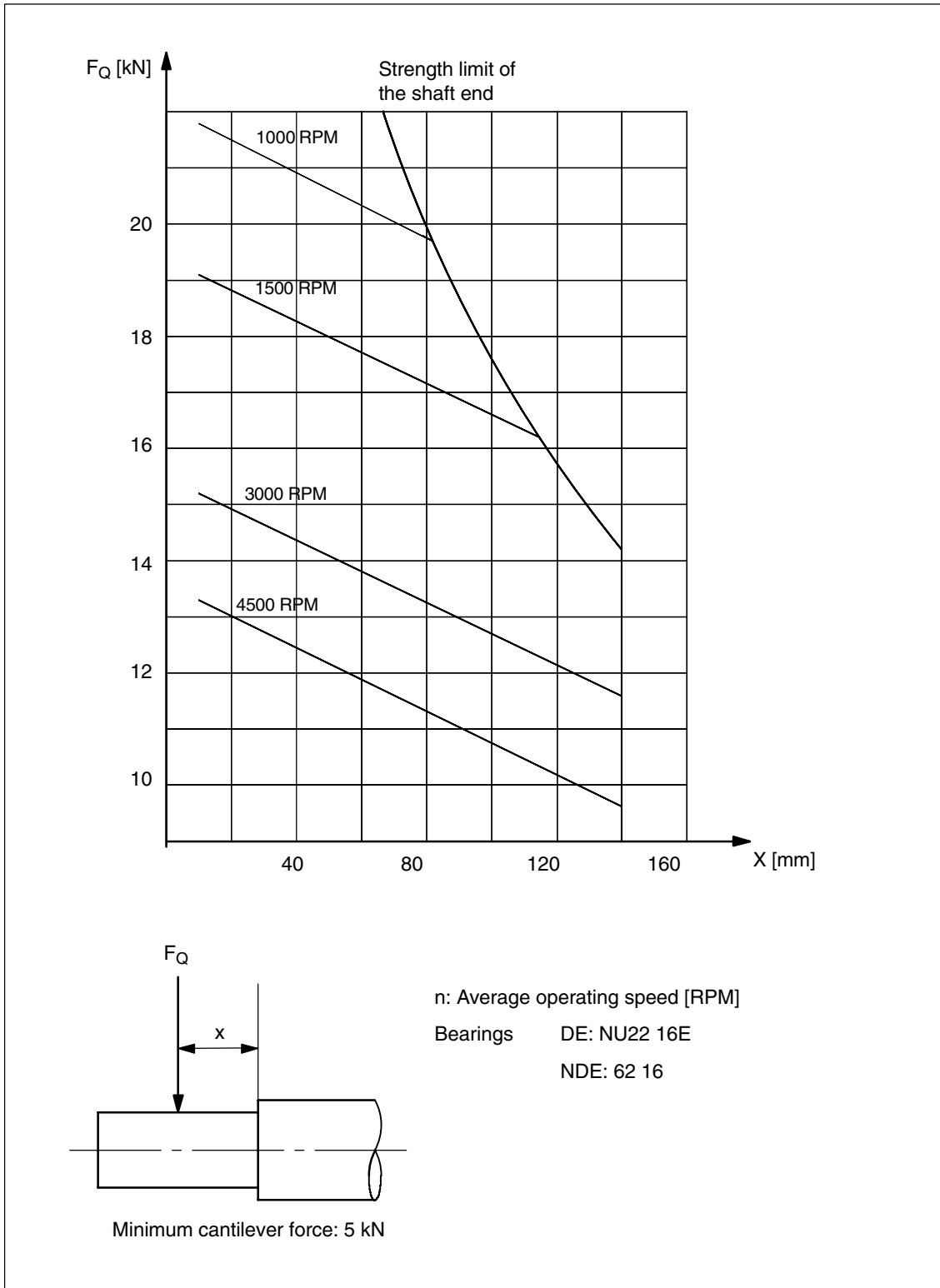

Fig. 2-71 Cantilever force diagram, shaft height 225 for belt out-drives (increased cantilever forces)

2.3.2 Axial force

The maximum axial forces F_{AZ} for horizontal motor mounting are specified in the following force diagrams.

The force diagrams and tables are only valid for standard drive shaft ends; non-standard drive shaft end dimensions are specified for each particular application corresponding to the permissible forces.

For force levels going beyond these, please contact your local Siemens office.

Shaft heights 180 and 225: For coupling, belt or pinion out-drive with straight teeth, generally, only low axial forces occur. The locating bearing is adequately dimensioned so that these forces can be accepted in all mounting positions.

The following forces due to the weight of the drive-out element are permissible at the shaft end in order to ensure perfect vibration characteristics (i.e. low vibration):

- SH 180: max 500 N
- SH 225: max. 600 N

For pinion out-drives with helical gearing, please contact your local Siemens office.

Note

The permissible axial force at the shaft end without taking into account the alignment forces of the rotor weight, the mounting position as well as the force direction.

Information regarding axial force stressing, refer to the Planning Guide "AC Induction Motors, General Section".

Table 2-63 Force due to weight F_L and alignment force F_C of the rotor

Motor type	Force due to the weight F_L [N]	Alignment force F_C [N]
1PH7101 1PH7103 1PH7105 1PH7107	125 125 200 200	400
1PH7133 1PH7135 1PH7137	290 410 410	600
1PH7163 1PH7167	520 630	800
1PH7184 1PH7186	980 1220	500 ¹⁾
1PH7224	1720	550 ¹⁾

1) only for coupling out-drive

SH 100, permissible axial force at the shaft end

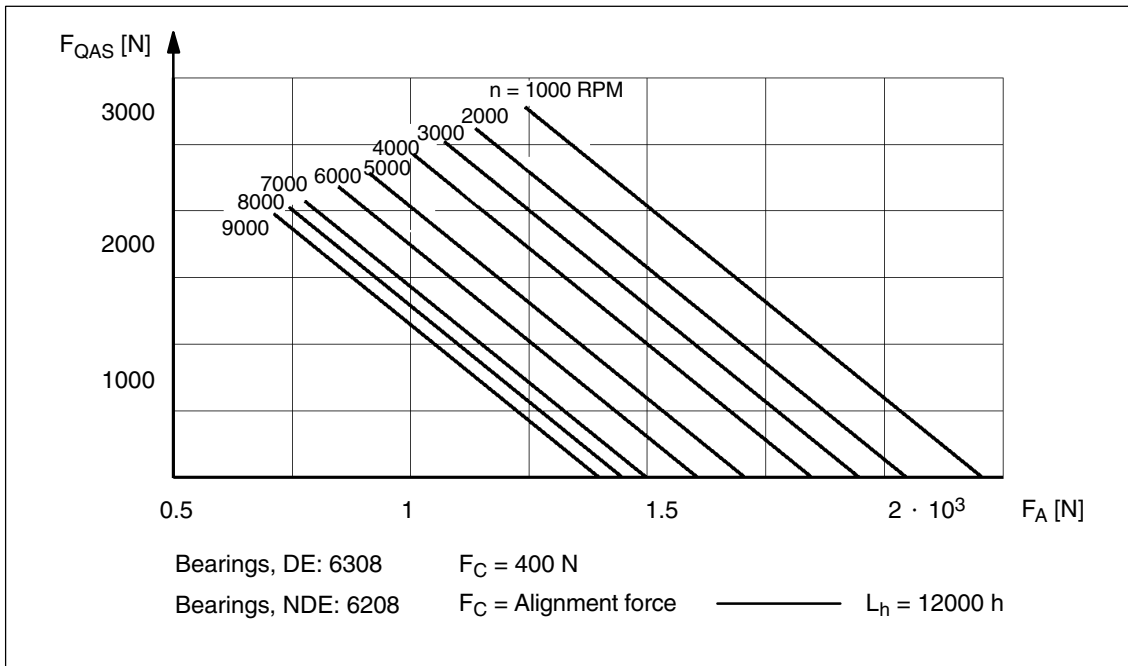

Fig. 2-72 Axial force diagram at the shaft end, shaft height 100

When determining the axial force, refer to the Planning Guide, "General Section".

SH 132, permissible axial force at the shaft end

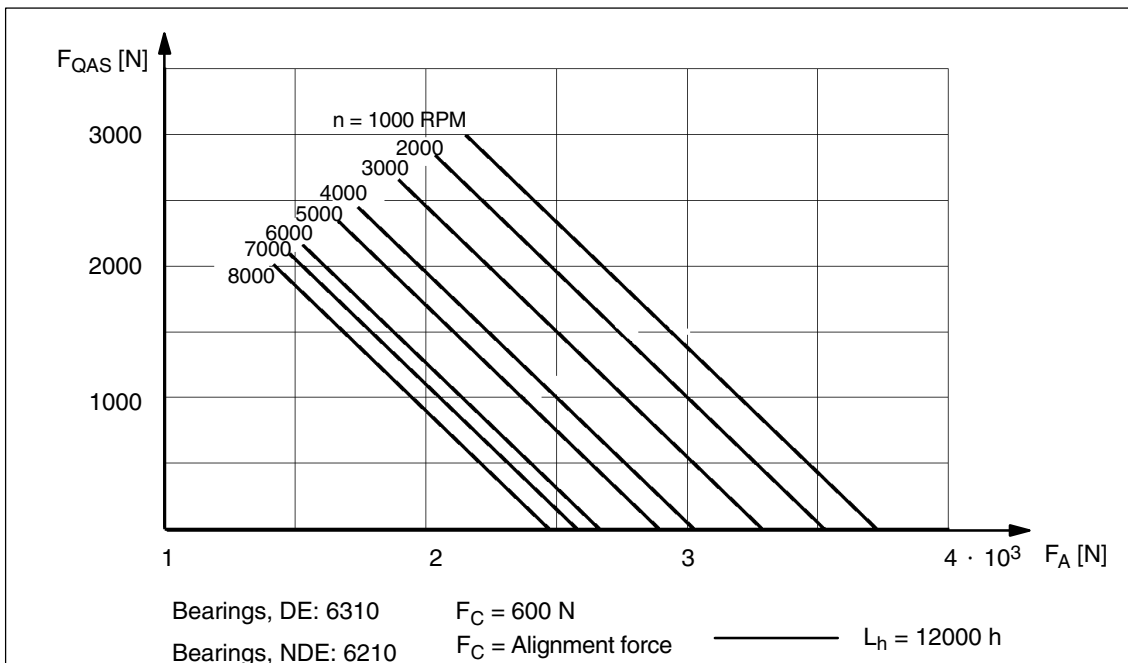

Fig. 2-73 Axial force diagram at the shaft end, shaft height 132

SH 160, permissible axial force at the shaft end

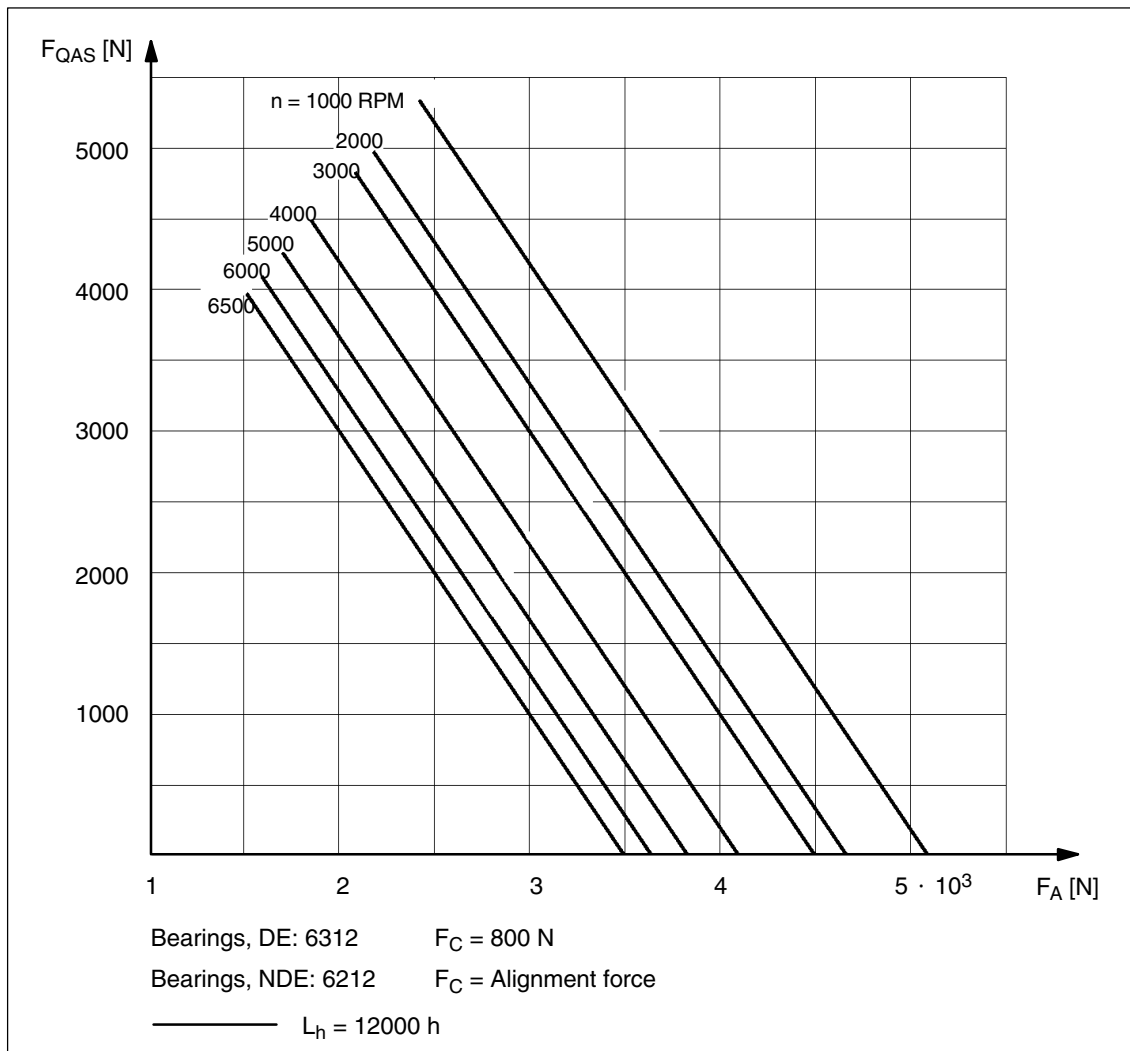

Fig. 2-74 Axial force diagram at the shaft end, shaft height 160

SH 100, permissible axial force at the shaft end for increased max. speed

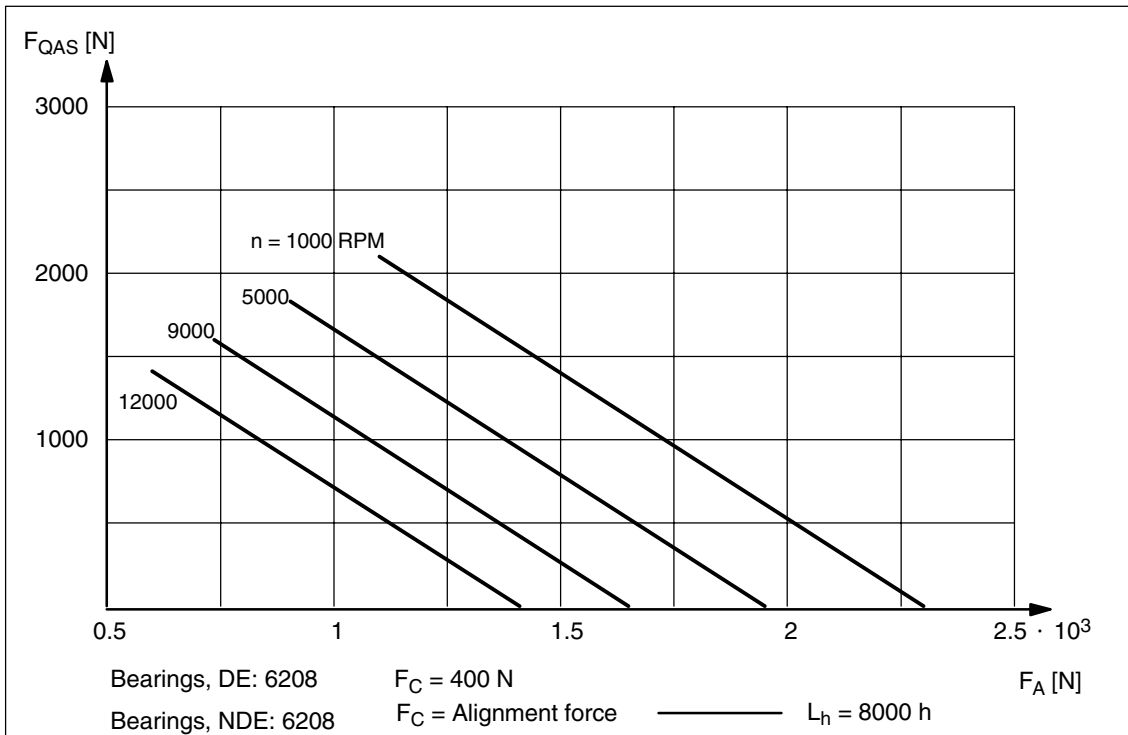

Fig. 2-75 Axial force diagram at the shaft end, shaft height 100 (increased max. speed)

SH 132, permissible axial force at the shaft end for increased max. speed

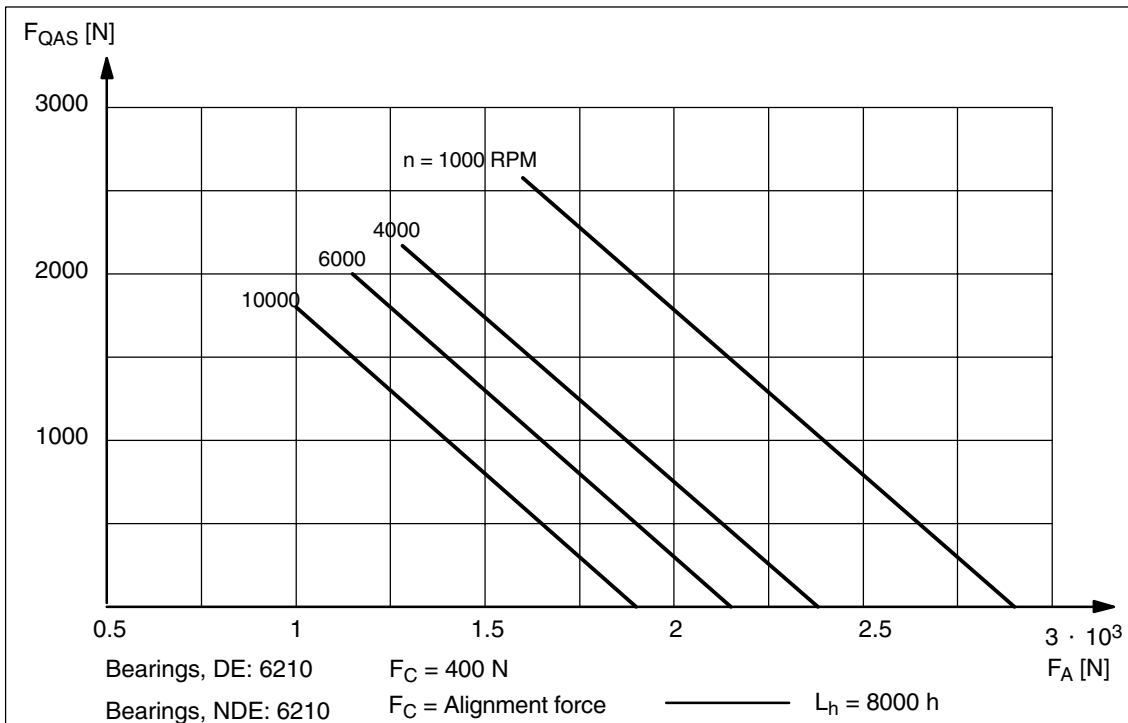

Fig. 2-76 Axial force diagram at the shaft end, shaft height 132 (increased max. speed)

SH 160, permissible axial force at the shaft end for increased max. speed

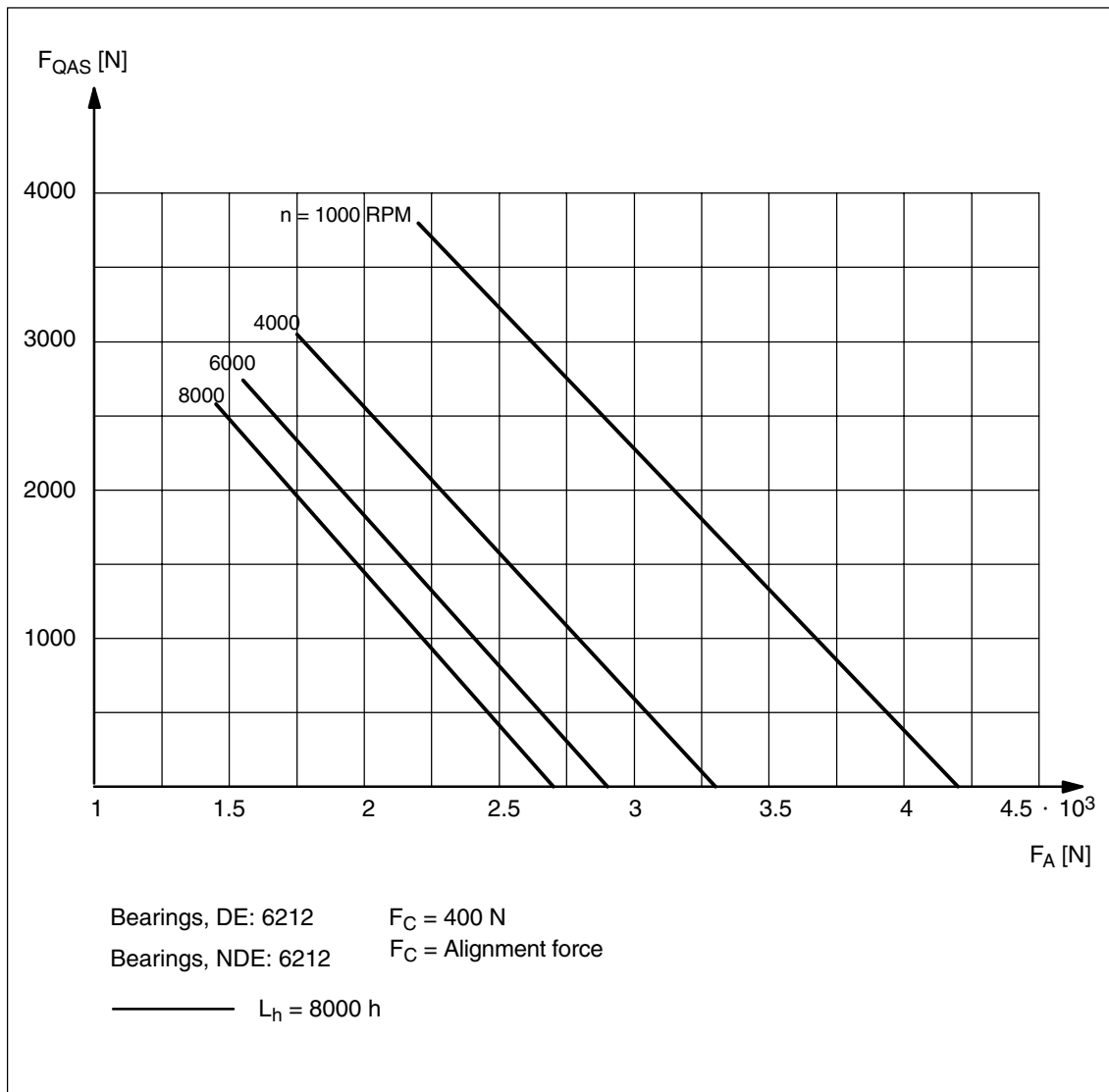

Fig. 2-77 Axial force diagram at the shaft end, shaft height 160 (increased max. speed)



Motor Components

3.1 Thermal motor protection

Table 3-1 Features and technical data

Type	KTY 84
Resistance when cold (20 °C)	approx. 580 Ohm
Resistance when hot (100 °C):	approx. 1000 Ohm
Connecting	Using the encoder cable
Response temperature	Warning < 120 °C Alarm/shutdown at max. 155 °C ± 5 °C

The resistance change is proportional to the winding temperature change. For 1PH7 motors, the temperature characteristic is taken into account in the closed-loop control.

The warning signal from the evaluation circuit in the SIMODRIVE drive converter can be externally evaluated.

High short-time overload conditions require additional protective measures. This is due to the thermal coupling time of the sensor. If the overload condition ($4 \cdot M_0$) lasts longer than 4 s, additional protection should be provided.

The temperature sensor cables are included in the encoder cable.



Warning

If the user carries-out an additional high-voltage test, then the ends of the temperature sensor cables must be short-circuited before the test is carried-out! If the test voltage is connected to only one terminal of the temperature sensor, it will be destroyed.



Warning

The integrated temperature sensor protects the induction motors against overload conditions up to

- 4 • I_0 (60 K) and speed \leftrightarrow 0

Sufficient protection is no longer provided for thermally critical load situations, e.g. for a high overload condition at motor standstill. In this case, other protective measures must be provided, e.g. a thermal overcurrent relay.

If they exist, reduced data for standstill are specified.

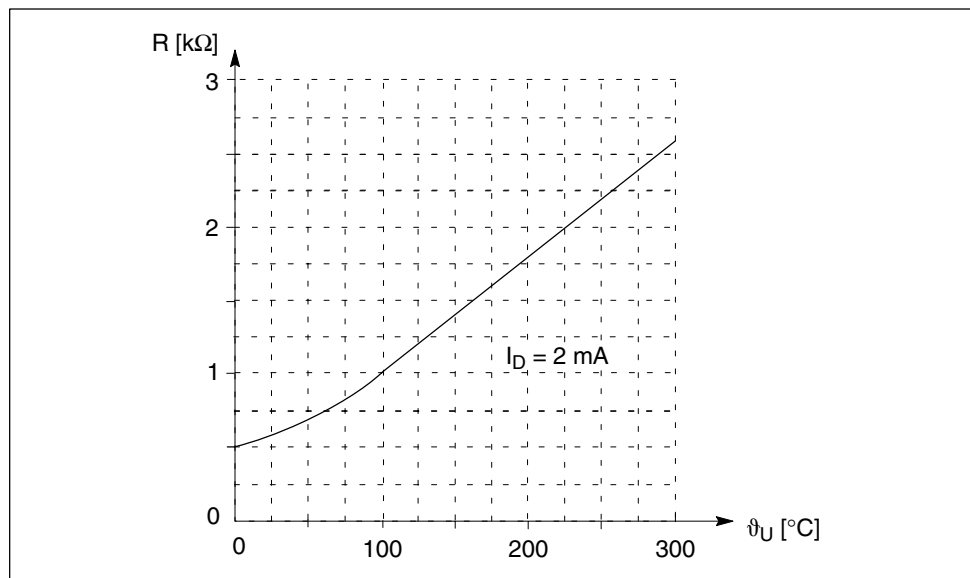

Fig. 3-1 Resistance characteristic as a function of the KTY 84 thermistor temperature

3.2 Encoders

Incremental encoder 1 V_{pp}

Table 3-2 Features and technical data

Version	Optical encoder system
Application	<ul style="list-style-type: none"> • Tachometer for speed actual value sensing • Indirect measuring system for the position control loop
Coupling	At the NDE, integrated in the motor
Output signals (refer to Fig. 3-2)	<ul style="list-style-type: none"> • Incremental track, sinusoidal • Reference signal
Connecting	Connector
Max. possible connecting cable length	50 m
Operating voltage	+ 5 V ± 5 %
Pulse number	2048
Output signals	1 V _{pp}
Accuracy	± 40"

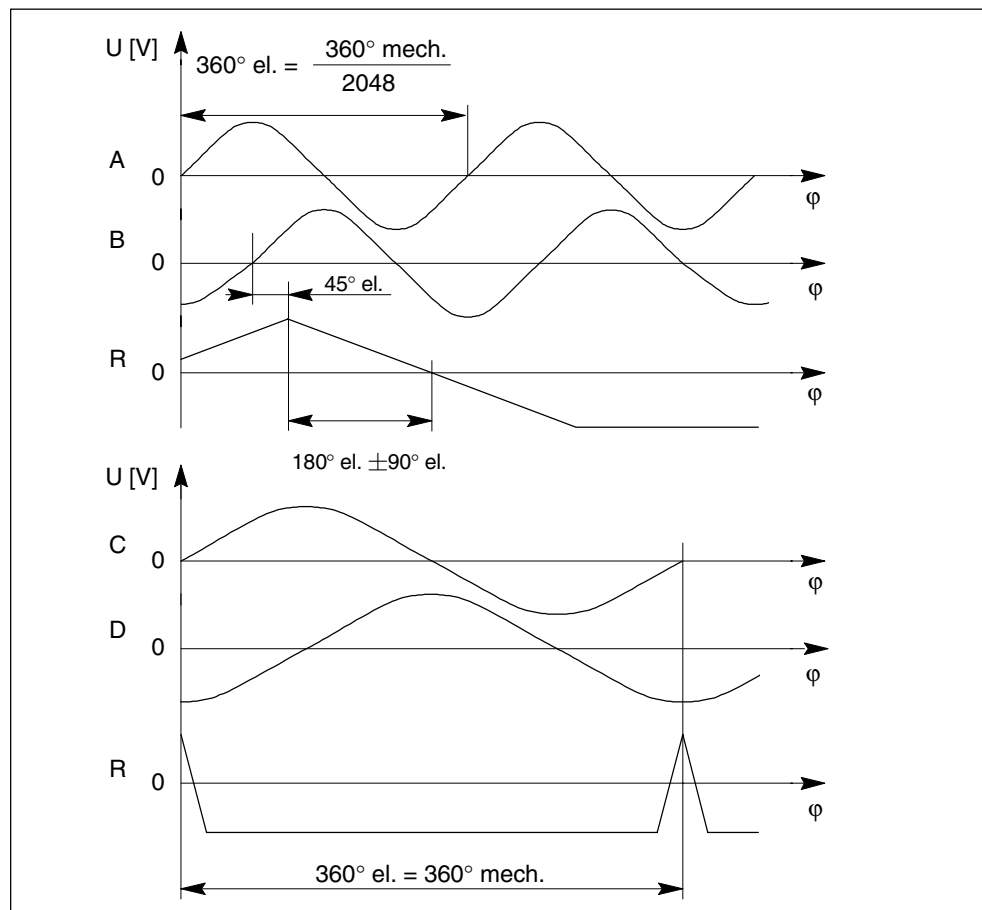
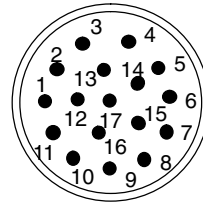

Fig. 3-2 Signal sequence and assignment for a positive direction of rotation (clockwise direction of rotation when viewing the drive end)

3.2 Encoders

Connection: 17 pin flange-mounted socket (pin contacts)

PIN No.	Signal
1	A+
2	A-
3	R+
4	not connected
5	not connected
6	not connected
7	M-Encoder
8	+Temp
9	-Temp
10	P-Encoder
11	B+
12	B-
13	R-
14	not connected
15	0 V Sense
16	5 V Sense
17	not connected



When viewing the plug-in side (pins)

Mating connector: 6FX2003-0CE17 (socket)

Pre-assembled cable: 6FX□002-2CA51-□□□0

Length
 8 = MOTION-CONNECT 800
 5 = MOTION-CONNECT 500

3.3 Gearboxes

A gearbox must be mounted, if

- the drive torque is not sufficient at low speeds
- the constant power range is not sufficient in order to utilize the cutting power over the complete speed range.

In order to mount a gearbox, depending on the shaft height, various prerequisites must be fulfilled.

Prerequisites for mounting a gearbox for SH 100 to SH 160

- Type of construction IM B5, IM B35 or IM V15
- Shaft with key and full-key balancing

Prerequisites for mounting a gearbox for SH 180 and SH 225

- IM B35 type of construction
- Bearing design for coupling out-drive
- Vibration severity level R
- Flange and shaft accuracy R
- Shaft with key and full-key balancing
- Degree of protection IP 55, prepared for mounting a ZF gearbox

For questions regarding gearboxes, please directly contact the following:

ZF Friedrichshafen AG

Antriebstechnik Maschinenbau

D-88038 Friedrichshafen

Telephone: (0 75 41) 77 – 0

Telefax: (0 75 41) 77 – 34 70

Internet: <http://www.ZF-Group.de>

3.3.1 Features

Gearbox features

- Version as planetary gear
- Gearbox efficiency: above 95 %
- Gearboxes are available for motors, shaft heights 100 to 225
- Selector gearboxes are available up to a drive output of 100 kW
- Types of construction: IM B35 (IM V15) and IM B5 (IM V1) are possible

Note

1PH7 motors are only designed for stressing in accordance with the specifications (refer to the cantilever force diagram and maximum torque).

For drive units where, for example, they are mounted to the gearbox flange or gearbox enclosure, then for motors with type of construction IM B35, they must be supported at the NDE without subjecting the motor frame to any stress.

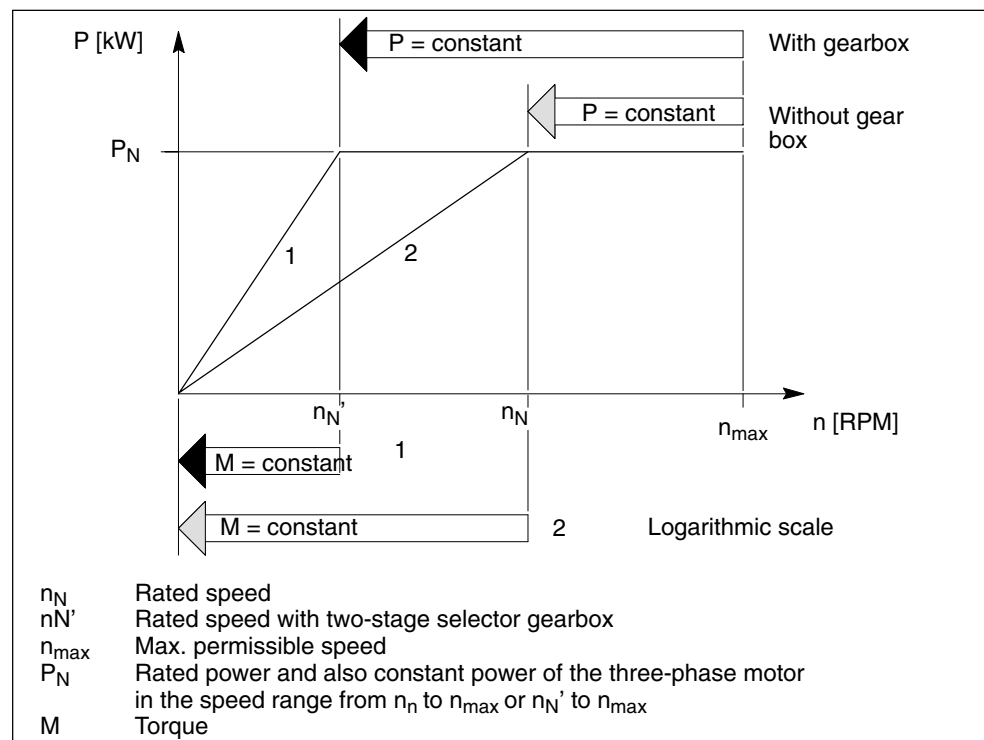

Fig. 3-3 Speed-power diagram when using a two-stage selector gearbox to extend the constant power speed range of AC main spindle drive motors

Examples

AC motor without selector gearbox

For $P = \text{constant}$ from $n_N = 1500 \text{ RPM}$ to $n_{\text{max}} = 6300 \text{ RPM}$ a constant power control range greater than 1:4 is possible.

AC motor with selector gearbox

For gearbox stage $i_1 = 4$ and $i_2 = 1$ a constant power control range of greater than 1:16 is possible ($n_N' = 375 \text{ RPM}$ to $n_{\text{max}} = 6300 \text{ RPM}$).

Gearbox mounted outside the spindle box

The following advantages are obtained by locating the gearbox outside the spindle box:

- Gearbox vibration is not transferred.
- Separate lubricating systems for the main spindle (grease) and selector gearbox (oil).
- No noise and no temperature fluctuations caused by the gearbox pinion wheels in the spindle box.
- Instead of using belts, the drive power can also be transferred from the gearbox out-drive using pinion (on request) or co-axially through an equalizing coupling.

Vibration severity level

Motor + gearbox: Tolerance R (acc. to DIN ISO 2373)

This is also valid if motor tolerance level S is ordered.

3.3.3 Technical data

Table 3-3 Explanation of the connections

Type	Motor shaft height	Order No.	Max. speed n_{\max}	Rated torque (S1 duty)			Max. torque (S6 duty, 10 min. duty cycle, max. 60% power-on duration)			Weight	Drive-out housing a10
				Drive	Drive out		Drive	Drive out			
ZF desig.	[mm]		[RPM]	[Nm]	i=1 [Nm]	i=4 [Nm]	[Nm]	i=1 [Nm]	i=4 [Nm]	[kg]	[mm]
2K120	100	2LG4312-...	8000 ²⁾ 9000 ³⁾	120	120	480	140	140	560	30	100
2K250	132	2LG4312-...	6300 8000 ³⁾	250	250	1000	400	400	1600	62	116
2K300	160	2LG4320-...	6300 8000 ³⁾	300	300	1200	400	400	1600	70	140
2K800 ¹⁾	184	2LG4250-...	4000	800	800	3200	900	900	3600	110	160
2K801 ¹⁾	186	2LG4260-...	4000	800	800	3200	900	900	3600	110	160
2K802	225	2LG4270-...	4000	800	800	3200	900	900	3600	110	160

Important

When designing the complete drive unit (motor with gear) the gearbox data is decisive.

For the 1PH7167-2NB motor, for example, the torque should be reduced to 300 Nm. For motors, shaft heights 100 and 132, the maximum motor speed should be limited to the permissible gearbox speed 2K 120 / 2K 250.

Other binding technical data and engineering information/instructions (e.g. lubrication, temperature rise, permissible cantilever forces and examples), please refer to Catalog 2K Gearboxes from ZF (Zahnradfabrik Friedrichshafen).

- 1) Can be supplied with holding brake (option).
- 2) Higher maximum speeds from 8000 ... 9000 RPM for more than 20 % power-on duration possible when using injection lubrication.
- 3) Permissible with gearbox oil cooling for gearbox stage $i = 1$.

3.3.4 Electrical connections

Power supply for the selector unit: 24 V DC $\pm 10\%$

The mechanical selector unit requires a separate supply.

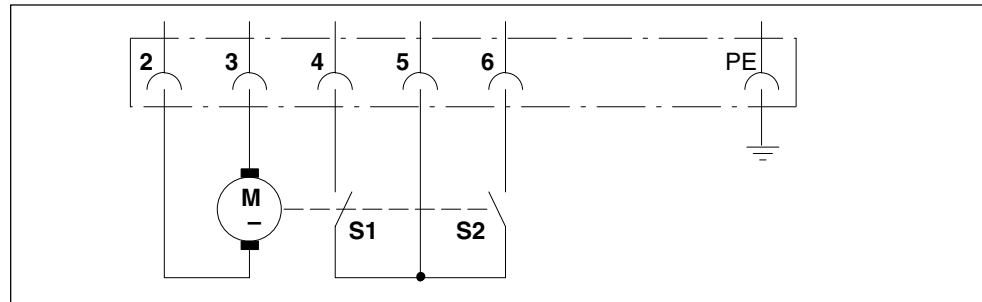

Fig. 3-5 Circuit diagram

Connector (incl. in the scope of supply): Manufacturer, Harting; 7-pin + PE, type HAN 7D

Table 3-4 Explanation of the connections

Connector contact No.	Number and designation	In-put	Out-put	Voltage	Current
2 and 3	1 selector unit	0	–	24 V DC	$I_{\max} = 5\text{ A}$ (inrush current)
4 and 6	2 limit switches	0	0	24 V DC $U_{\max} = 42\text{ V DC}$	$I_{\max} = 5\text{ A}$

Table 3-5 Control sequence when selecting the gearbox stage

Gearbox stage selection	Connector contact No.			
	2	3	4/5 (S1)	5/6 (S2)
When changing the ratio from stage i_2 to i_1				
a Initial setting (f)	+24 V DC	0 V	0	L
b Selection sequence			0	0
c Mechanical selection carried-out up to endstop ¹⁾			L	0
When changing the ratio from stage i_1 to i_2				
d Initial setting (c)	0 V	+24 V DC	L	0
e Selection sequence			0	0
f Mechanical selection carried-out up to endstop ¹⁾			0	L

L Contact closed

0 Contact open

1) A limit switch (S1 or S2) sends a signal to the control after selection to switch out the selector unit.

3.3.5 Gearbox stage selection

When changing the gearbox stage, the following information must be carefully observed:

- Only change over the gearbox stage at standstill; e.g. while changing the tool.
- During selection, the direction of rotation should be changed approximately 5 times per second. The gears normally mesh at the first direction of rotation change so that selection times of between 300 and 400 ms can be achieved. The “oscillation” function is provided in the SIMODRIVE 611 analog drive converter for this purpose.
- The gearbox stage should not be changed without oscillation.
- The motor may only start to accelerate 200 ms after the changeover has been completed.
- The selection must be monitored using a time relay. After 2 s, the selection must be reversed, if the selection command was not able to be executed. A time limit of 10 s should be provided for approx. 4 to 5 additional selection operations.

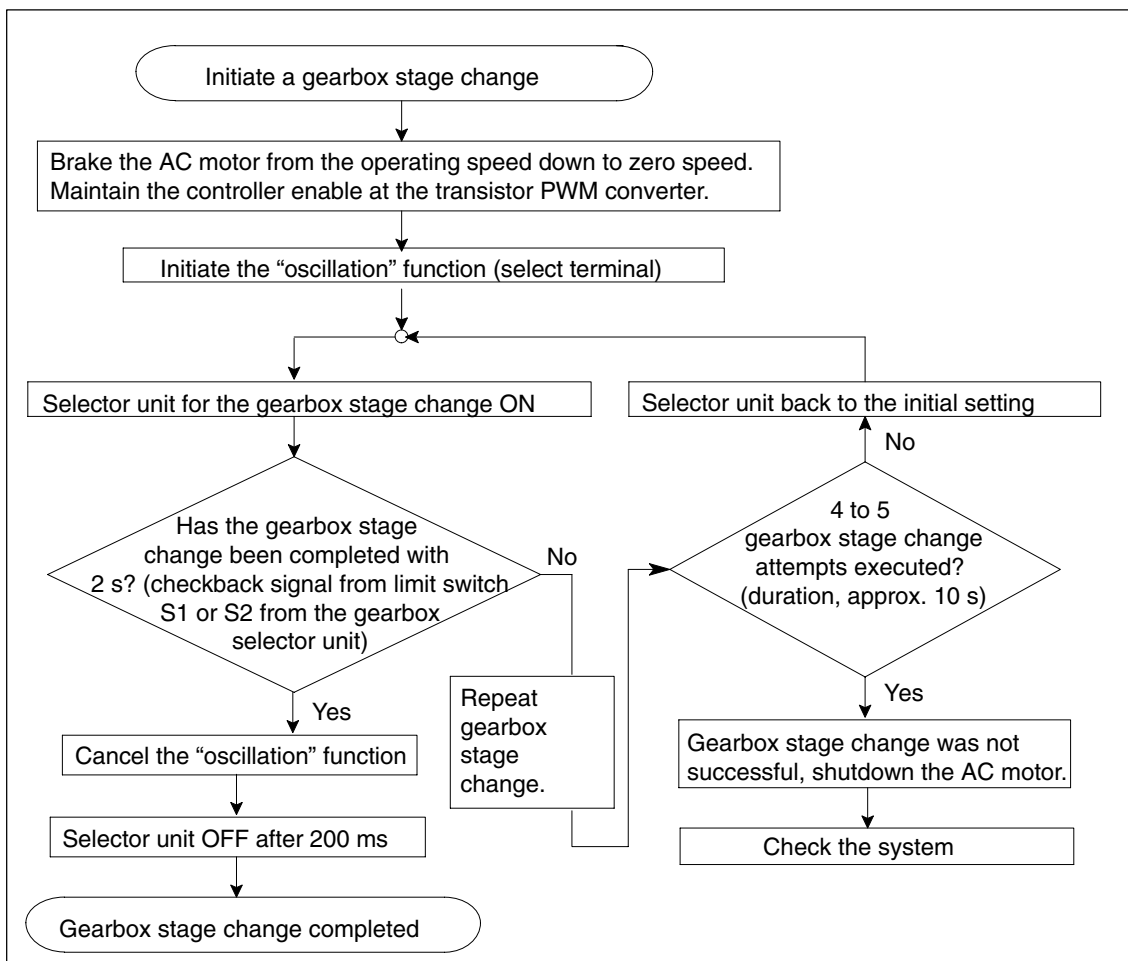

Fig. 3-6 Function sequence when changing the gearbox stage

3.3.6 Lubrication

Splash lubrication

Oil level check:	Visually using a sight glass
The oil level depends on the mounting position:	
Horizontal and vertical:	Center of the sight glass ¹⁾
For an inclined mounting position:	Mark on the angled oil level indicator (additionally mount)
Oils which can be used:	HLP 32 acc. to ISO-VG 68
Oil drain plugs:	Provided at both sides

Circulating oil lubrication

Circulating oil lubrication is required for the following applications:

- for continuous operation;
- for operation over a longer period of time in one gearbox stage;
- for intermittent operation with short no-load intervals;

The type of circulating oil lubrication depends on which operating temperature level is required in use. Several applications require a low operating temperature level. We recommend, in these cases, circulating oil lubrication. The oil intake quantity is between 1 and 1.5 l/min with an oil pressure of approx. 1.5 bar. The diagrams 3-8 and 3-9 indicate the approximate oil intake and outlet positions on the gearbox. The precise dimensions can be taken from the relevant mounting drawings.

The following gearboxes must always be operated with circulating oil lubrication (also refer to the mounting drawings):

- Gearbox 2K800
- Gearbox 2K801
- Gearbox 2K802
- Gearbox 2K2100

For the following gearboxes, circulating oil lubrication is required for V1 or V3 vertical mounting positions:

- Gearbox 2K120
- Gearbox 2K121
- Gearbox 2K250
- Gearbox 2K300

1) The oil volume data on the rating plate is only an approximate value

3.3.7 Flange dimensions

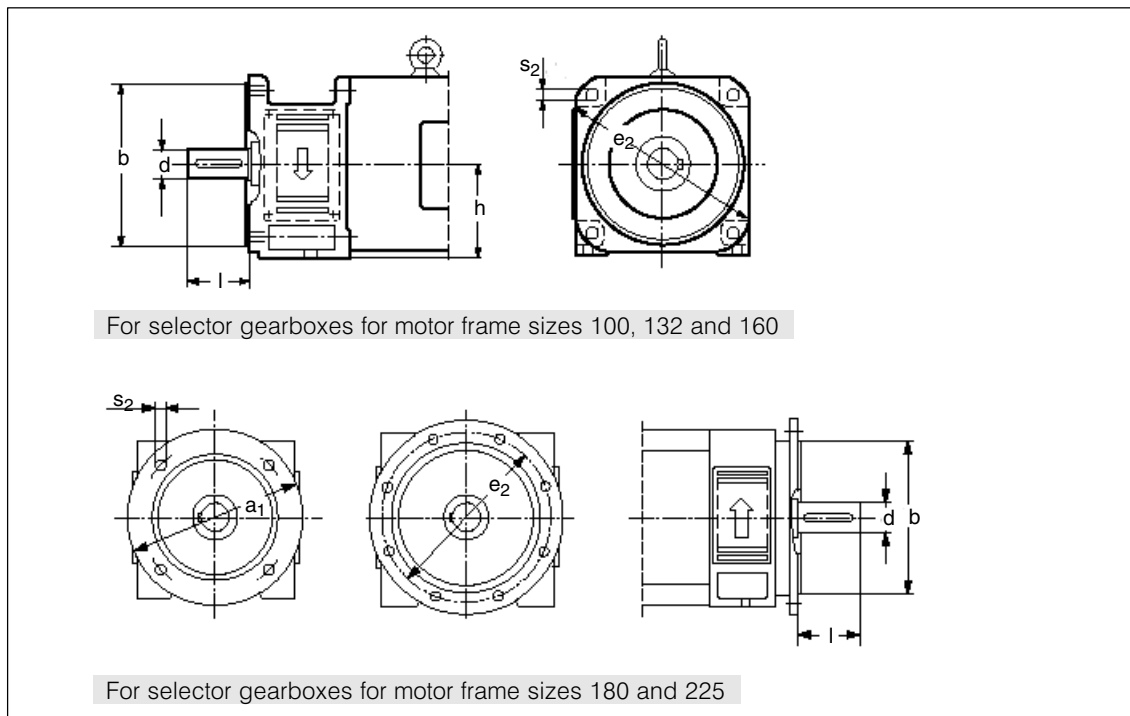

Fig. 3-7 Flange dimension for AC motors (dimensions refer to Table 3-6)

Table 3-6 Flange dimension for AC motors

Two-stage selector gearbox	Motor frame size	Standard motor companion dimensions						
		h	d	l	b ₁	e ₁	a ₁	s ₁
2 K 120	101, 103, 105, 107	100-0.5	38 k ₆	80	180 j ₆	215±0.5	-	14±0.2
2 K 250	131, 132, 133, 135, 137	132-0.5	42 k ₆	110	250 h ₆	300±0.5	-	18±0.2
2 K 300	163, 167	160-0.5	55 k ₆	110	300 h ₆	350±0.5	-	18±0.2
2 K 800	184	180-0.5	60 k ₆	140	300 h ₆	350±0.5	400	19±0.2
2 K 801	186	180-0.5	65 k ₆	140	350 h ₆	400±0.5	450	19±0.2
2 K 802	224	225-0.5	75 k ₆	140	450 h ₆	500±0.5	550	19±0.2

3.3.8 Connections, circulating oil lubrication, frame size 100

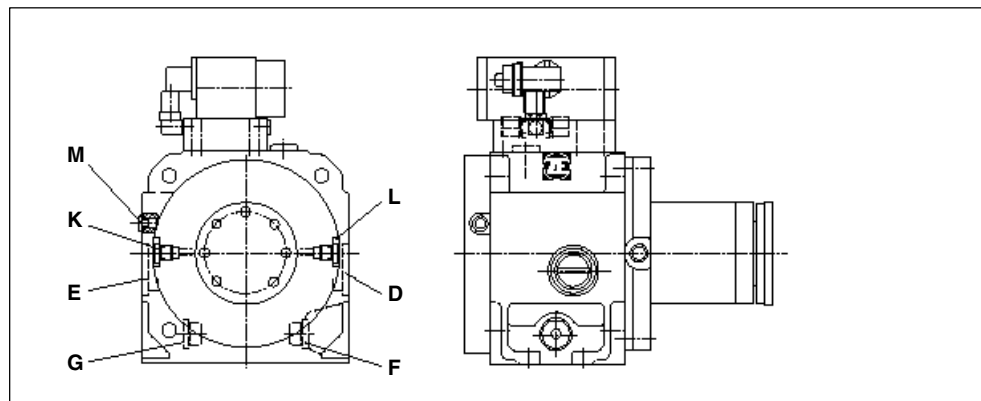

Fig. 3-8 Selector gearbox with selector unit for frame size 100

Table 3-7 Connections for circulating oil lubrication

Max. pressure	Connection, oil return	Connection, oil intake	Mounting position
0.2 bar 1.5 bar	D Main direction of rotation, clockwise ¹⁾	M (0.5 dm ³ /min) K/L (1.0 dm ³ /min)	V1 (closed version)
1.5 bar		G (1.5 dm ³ /min) main direction of rotation, clockwise F (1.5 dm ³ /min) main direction of rotation, counter-clockwise ¹⁾	B5 V1
Note: Circulating oil lubrication is required for certain gearboxes and V1 or V3 vertical mounting positions (refer to Subsection 3.3.6)			

1) When viewing the gearbox drive from the motor

3.3.9 Connections, circulating oil lubrication, frame sizes 132 and 160

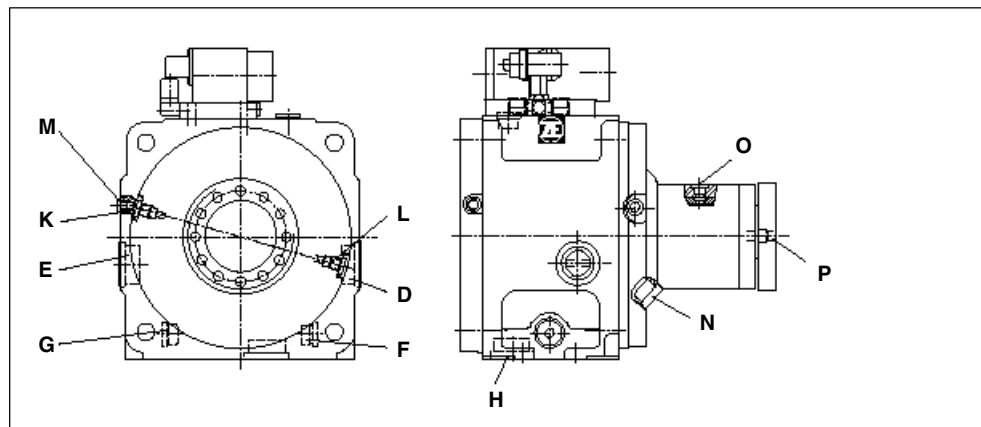

Fig. 3-9 Selector gearbox with selector unit for frame sizes 132 and 160

Table 3-8 Connections for circulating oil lubrication

Max. pressure	Connection, oil return	Connection, oil intake	Mounting position
2 bar	H	P (1.5 dm ³ /min)	V3
0.5 bar 1.5 bar	D Main direction of rotation, clockwise ¹⁾	M (0.5 dm ³ /min) N (1.5 dm ³ /min)	V1 (closed version)
1.5 bar		G (1.5 dm ³ /min) main direction of rotation, clockwise F (1.5 dm ³ /min) main direction of rotation, counter-clockwise	B5 V1
1.5 bar	E Main direction of rotation, counter-clockwise ¹⁾		
Note: Circulating oil lubrication is required for certain gearboxes and V1 or V3 vertical mounting positions (refer to Subsection 3.3.6)			
Connection O is additionally possible (0.5 dm³/min)			

1) When viewing the gearbox drive from the motor

3.3.10 Gearbox dimensions

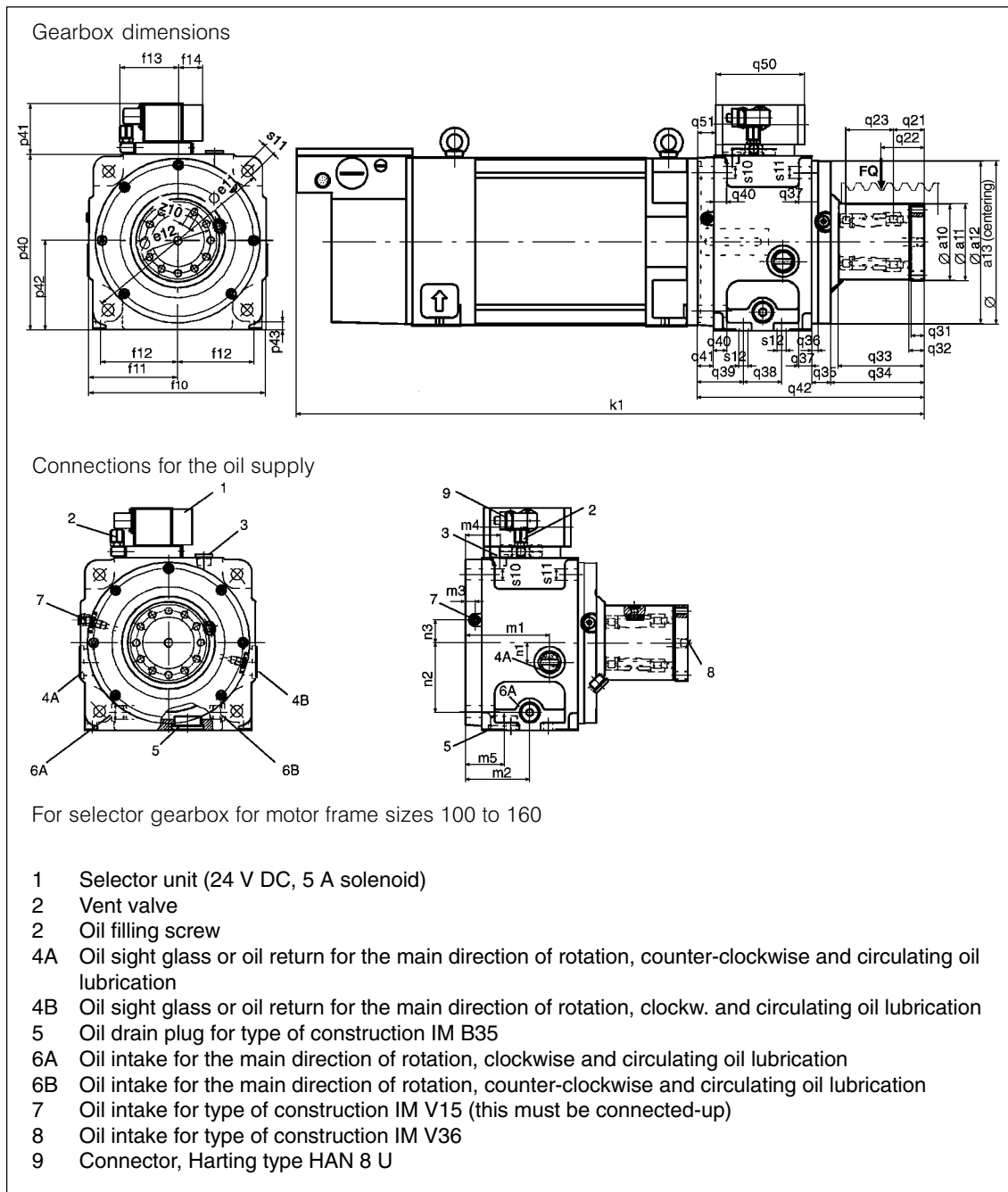

Fig. 3-10 AC motor and gearbox dimensions

Table 3-9 Two-stage selector gearbox (dimensions, overview 1)

Motor		Dimensions in mm																
Size	Type	a10	a11	a12	a13	e11	e12	f10	f11	f12	f13	f14	h	m1	m2	m3	m4	m5
		Drive-out housing	k6		g6	0.2							Shaft height					
100	1PH7 101	100	100	188	190	215	80	208	104	92	86.6	42.4	100	107	90.5	15	45	–
	1PH7 103																	
	1PH7 105																	
	1PH7 107																	
132	1PH7 131	116	118	249	250	300	100	270	135	117	89.5	39.5	132	131	100	15	53	60
	1PH7 133																	
	1PH7 135																	
	1PH7 137																	
160	1PH7 163	140	130	249	250	350	100	326	163	145	89.5	39.5	160	131	100	15	53	60
	1PH7 167																	

Table 3-10 Two-stage selector gearbox (dimensions, overview 2)

Motor		Dimensions in mm															
Size	Type	n1	n2	n3	p40	p41	p42	p43	q21	q22	q23	q31	q32	q33	q34	q35	q36
100	1PH7 101	17	80	30	209	92	108	12	42	57–67	75	15	17.5	–	116	26	10
	1PH7 103																
	1PH7 105																
	1PH7 107																
132	1PH7 131	30	108	35	268	78	136	12	46.9	57–66	72.1	20	22.5	129.5	142.5	29	10
	1PH7 133																
	1PH7 135																
	1PH7 137																
160	1PH7 163	30	135	35	324	78	164	17	48.2	74–83	69.8	20	22.5	–	142.5	29	10
	1PH7 167																

3.3 Gearboxes

Table 3-11 Two-stage selector gearbox (dimensions, overview 3)

Motor		Dimensions in mm													
Size	Type	q37	q38	q39	q40	q41	q42	q50	q51	s10	s11	s12	z10 Thread	No. of tapped holes	Motor with gearbox, total length k1
100	1PH7 101	18	55	63	18	25	298	136	12	14	14	14	M8	8x45°	709
	1PH7 103														709
	1PH7 105														804
	1PH7 107														804
132	1PH7 131	20	58	71	20	25	346.5	136	28	18	18	14	M12	12x30°	885
	1PH7 133														885
	1PH7 135														970
	1PH7 137														970
160	1PH7 163	20	58	71	23	25	346.5	136	28	18	18	14	M12	12x30°	987
	1PH7 167														1047



4

Dimension Drawings

For 1PH7 motors, for the dimensions, specified in the following table, the subsequent deviations are permissible.

Table 4-1 Permissible dimension deviations

Dimen-sions	Permissible deviations		
a,b	up to 250 mm		± 0.75 mm
	above 250 mm to 500 mm		± 1.0 mm
	above 500 mm to 750 mm		± 1.5 mm
b ₁	up to 230 mm	DIN 7160	j6
	above 230 mm		h6
d, d ₁	up to 11 mm	DIN 7160	j6
	above 11 mm up to 50 mm		k6
	above 50 mm		m6
e ₁	up to 200 mm		± 0.25 mm
	above 200 mm up to 500 mm		± 0.5 mm
h	above 50 mm up to 250 mm	DIN 747	-0.5 mm
	above 250 mm up to 500 mm		-1.0 mm
i, i ₁ , i ₂	up to 85 mm		± 0.75 mm
	above 85 mm up to 130 mm		± 1.0 mm
	above 130 mm up to 240 mm		± 1.5 mm
u, t, u ₁ , t ₁	acc. to DIN 6885 Sheet 1		

Note

Siemens AG reserves the right to change the dimensions of motors without prior notice as part of ongoing improvements to the mechanical design. Dimension drawings can go out-of-date. Updated dimension drawings can be requested at no charge.

4.1 Type of construction IM B3 with separately-driven fan

4.1 Type of construction IM B3 with separately-driven fan

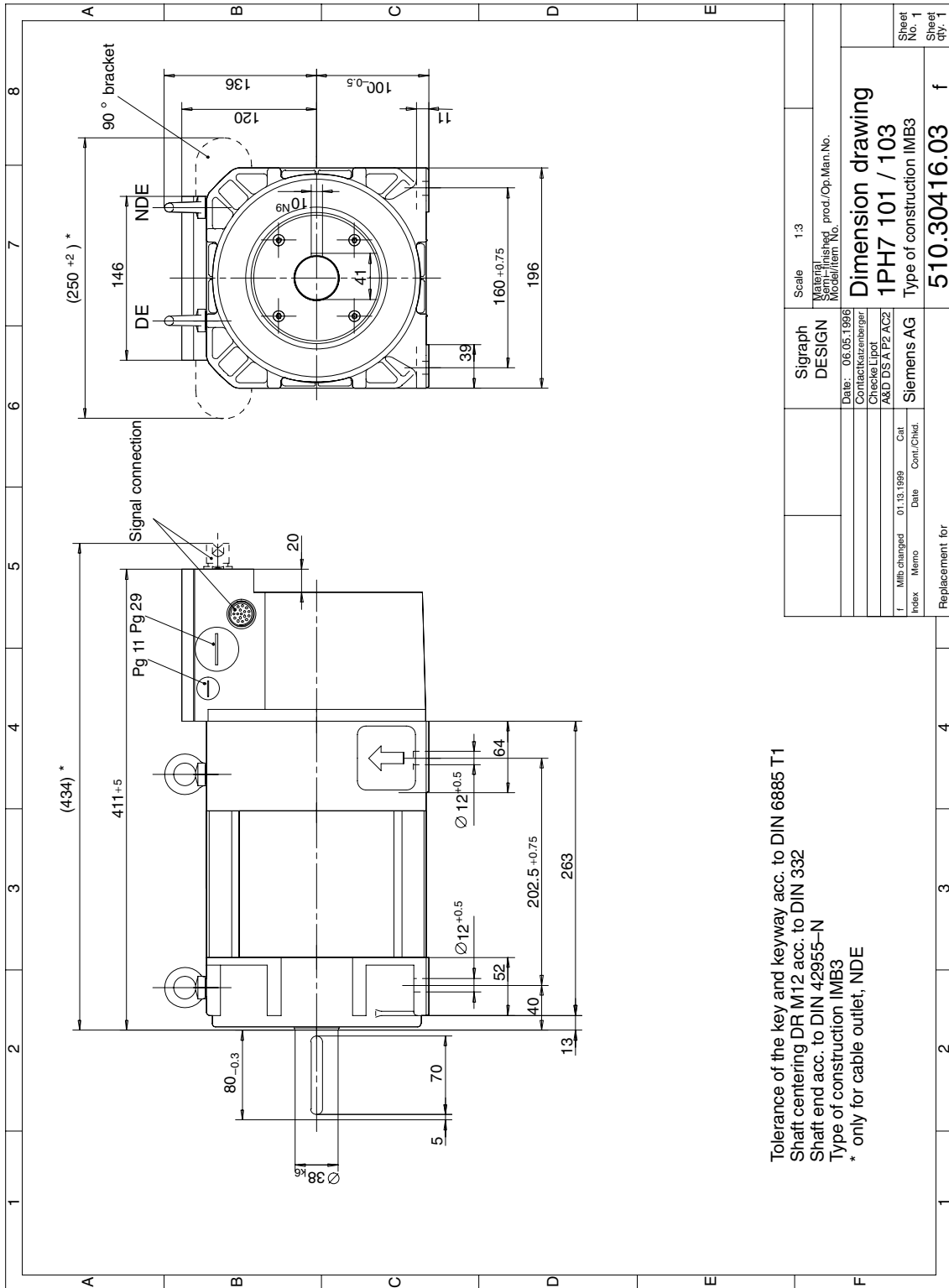

Fig. 4-1 1PH7101/1PH7103, type of construction IM B3 with separately-driven fan

4.1 Type of construction IM B3 with separately-driven fan

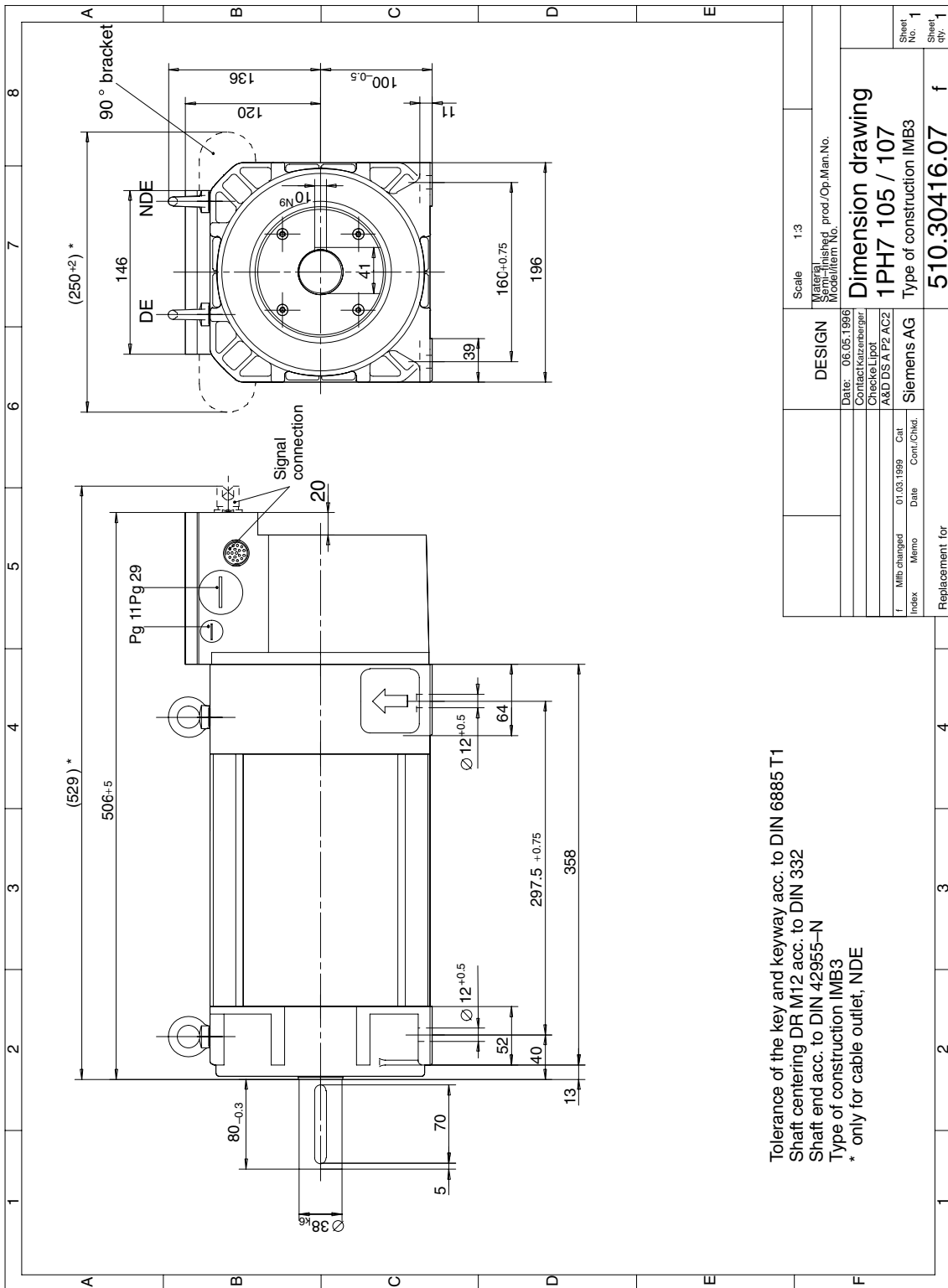

Fig. 4-2 1PH7105/1PH7107, type of construction IM B3

4.1 Type of construction IM B3 with separately-driven fan

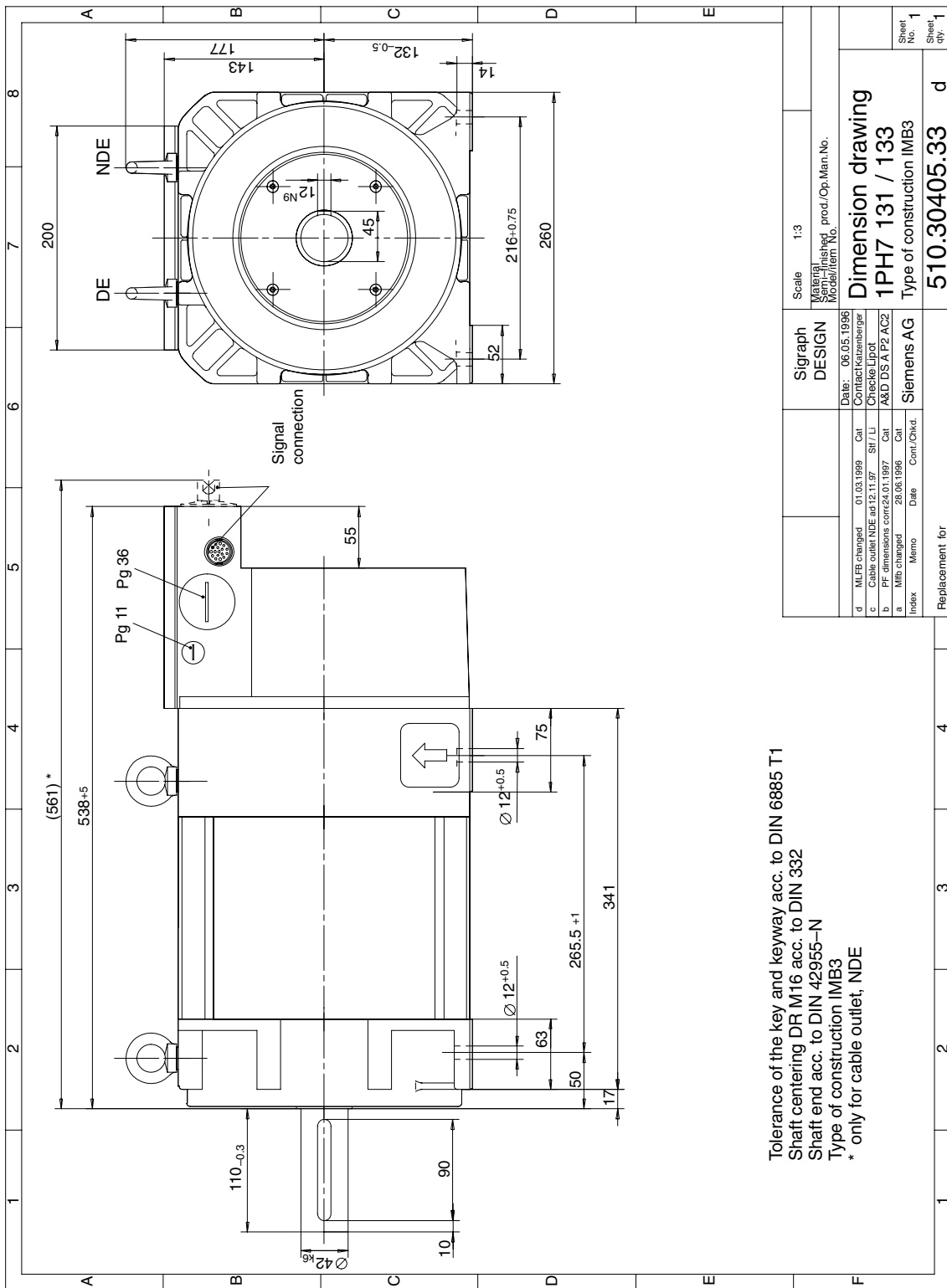

Fig. 4-3 1PH7131/1PH7133, type of construction IM B3

4.1 Type of construction IM B3 with separately-driven fan

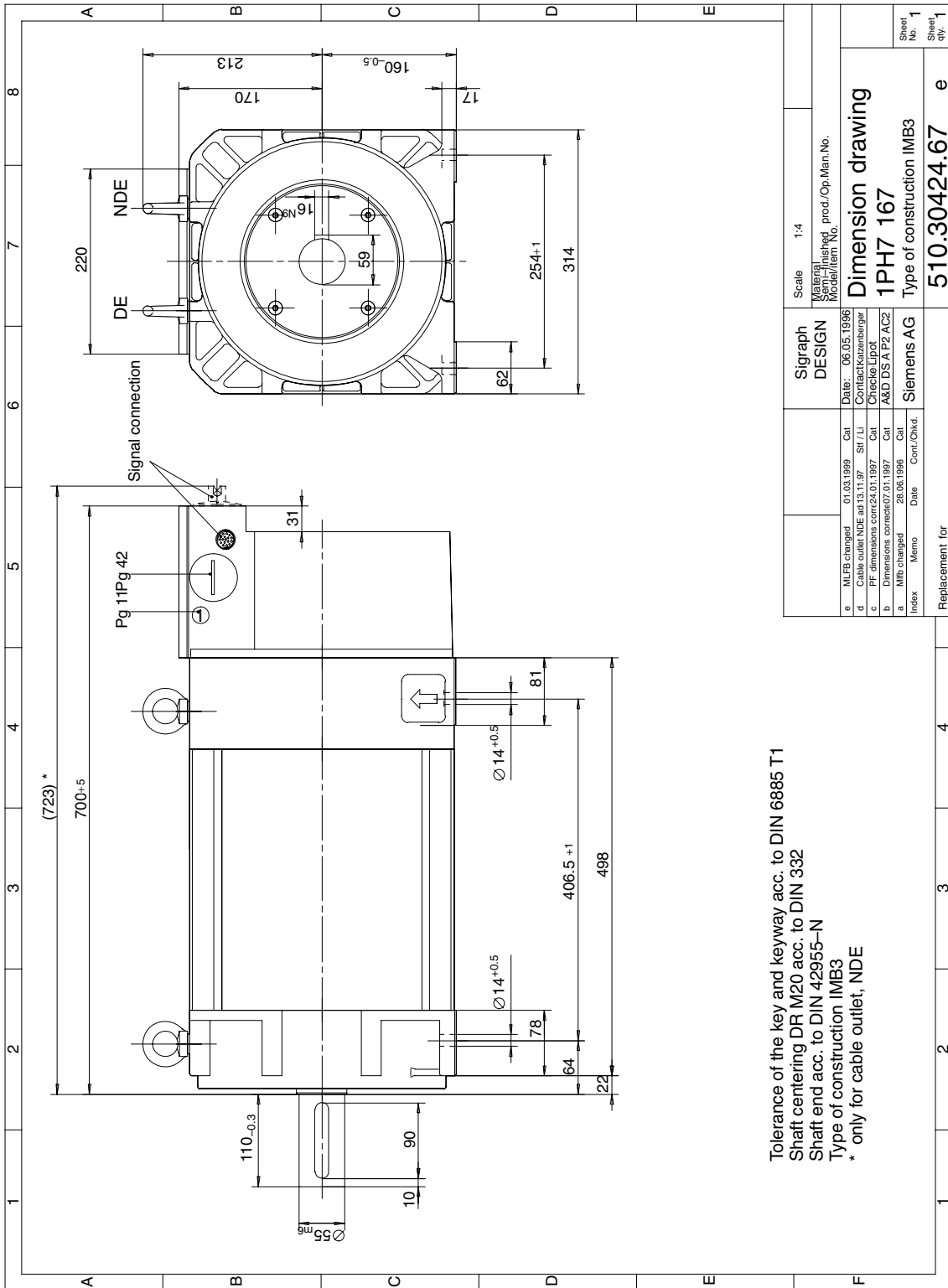

Fig. 4-6 1PH7167, type of construction IM B3

4.1 Type of construction IM B3 with separately-driven fan

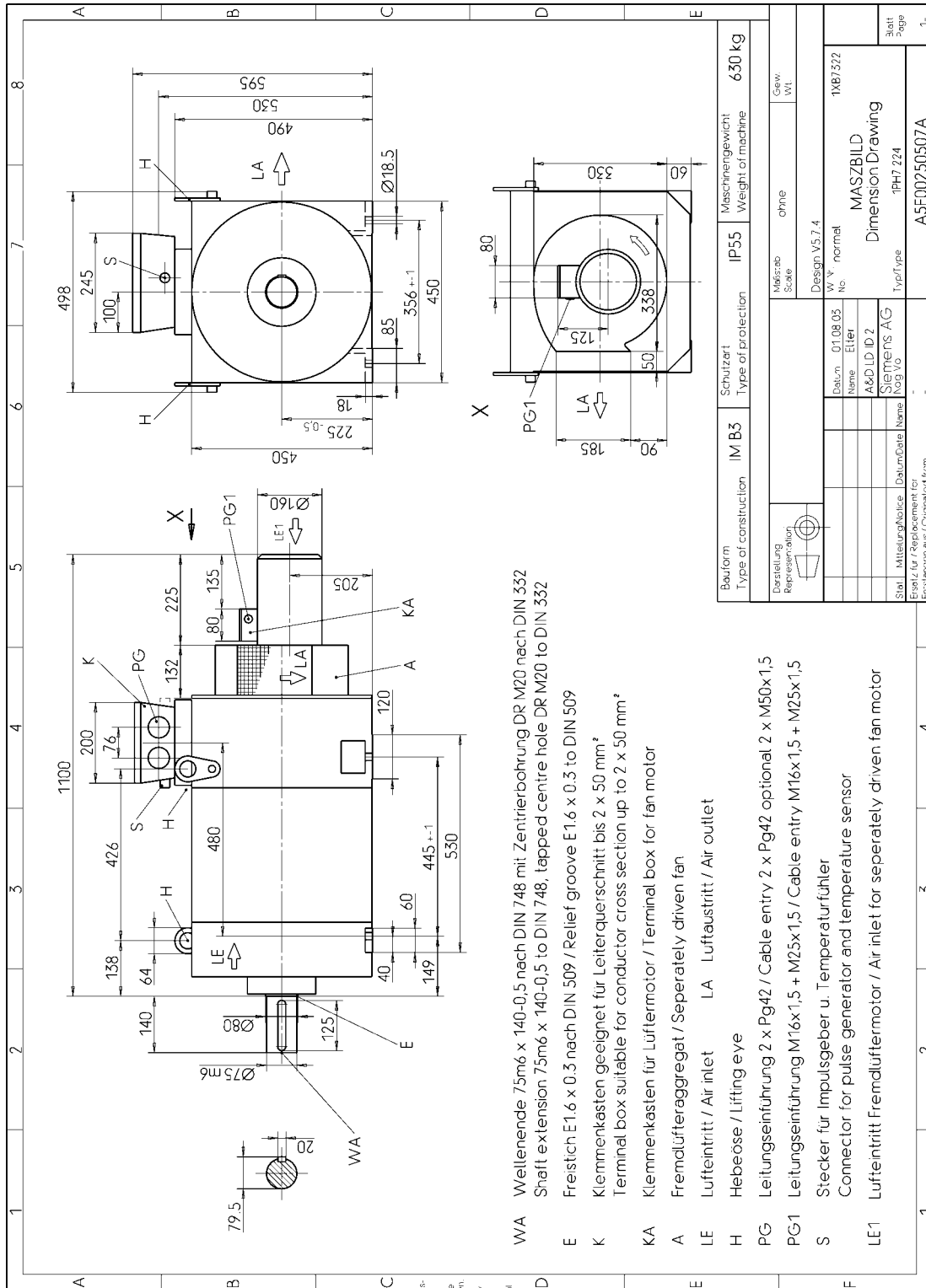

Fig. 4-11 1PH7224-NC/D/F, type of construction IM B3, air flow direction DE → NDE

4.1 Type of construction IM B3 with separately-driven fan

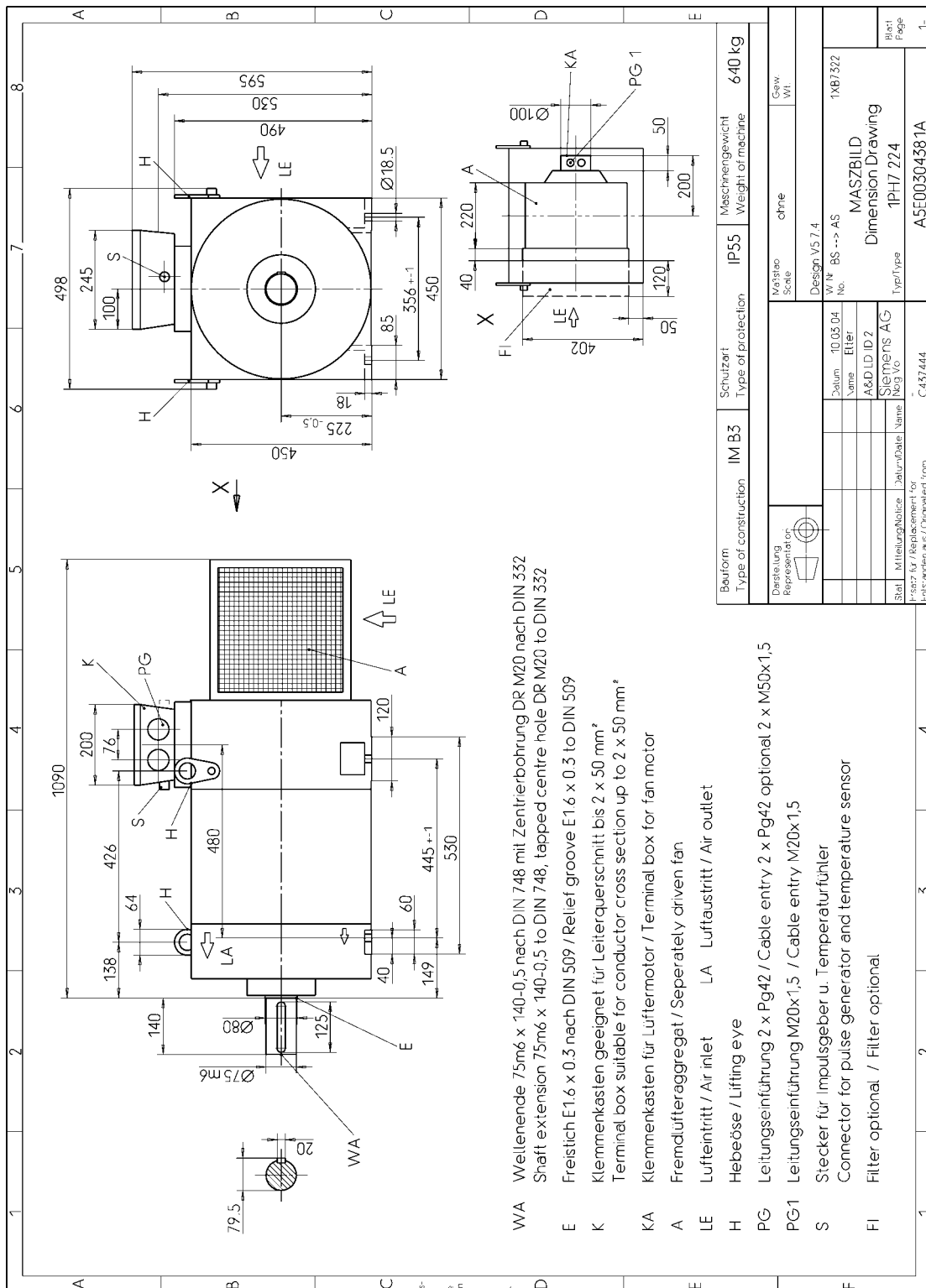

Fig. 4-12 1PH7224-NC/D/F, type of construction IM B3, air flow direction NDE → DE

4.2 Type of construction IM B5 with separately-driven fan

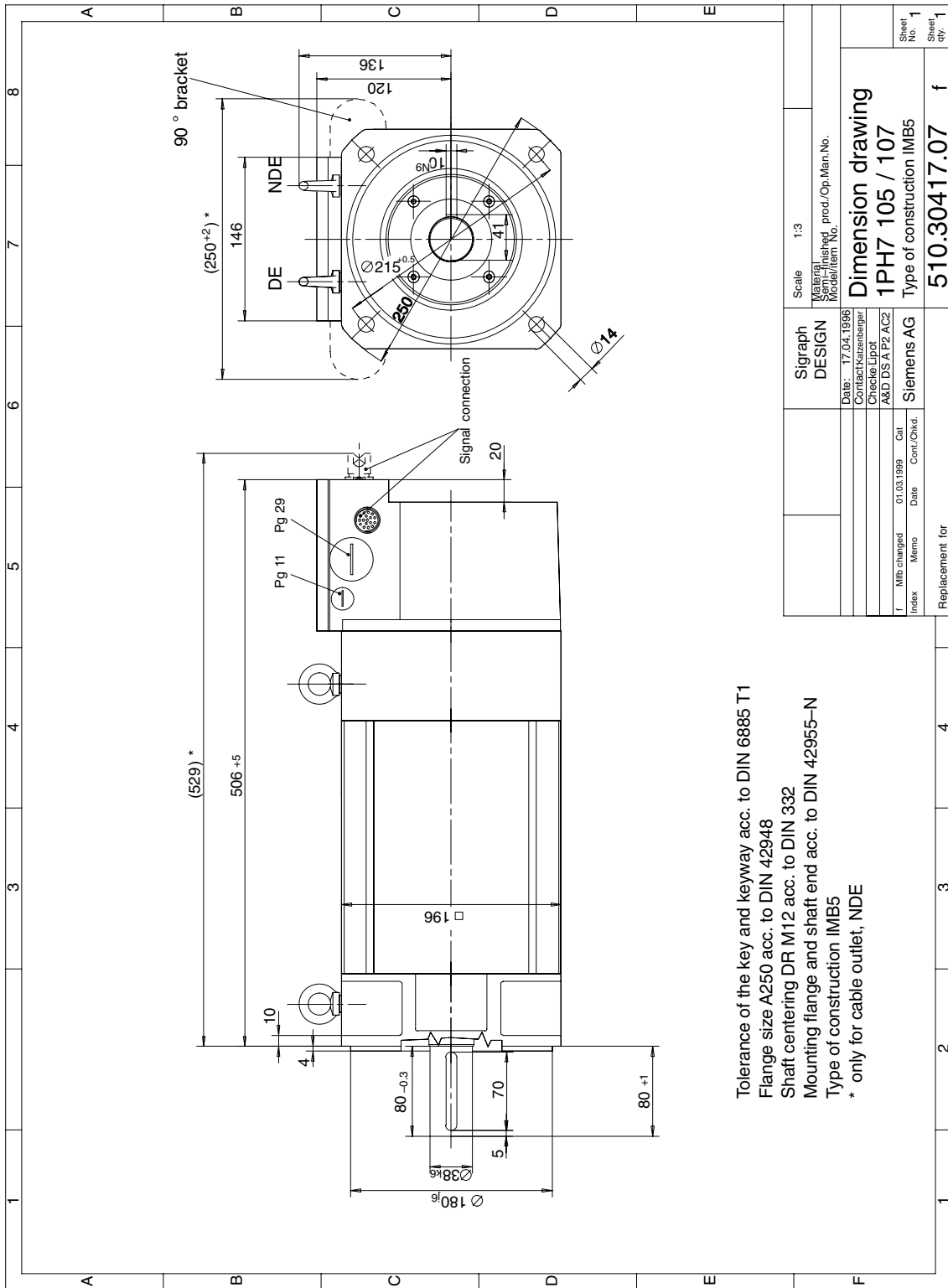

Fig. 4-14 1PH7105/1PH7107, type of construction IM B5

4.2 Type of construction IM B5 with separately-driven fan

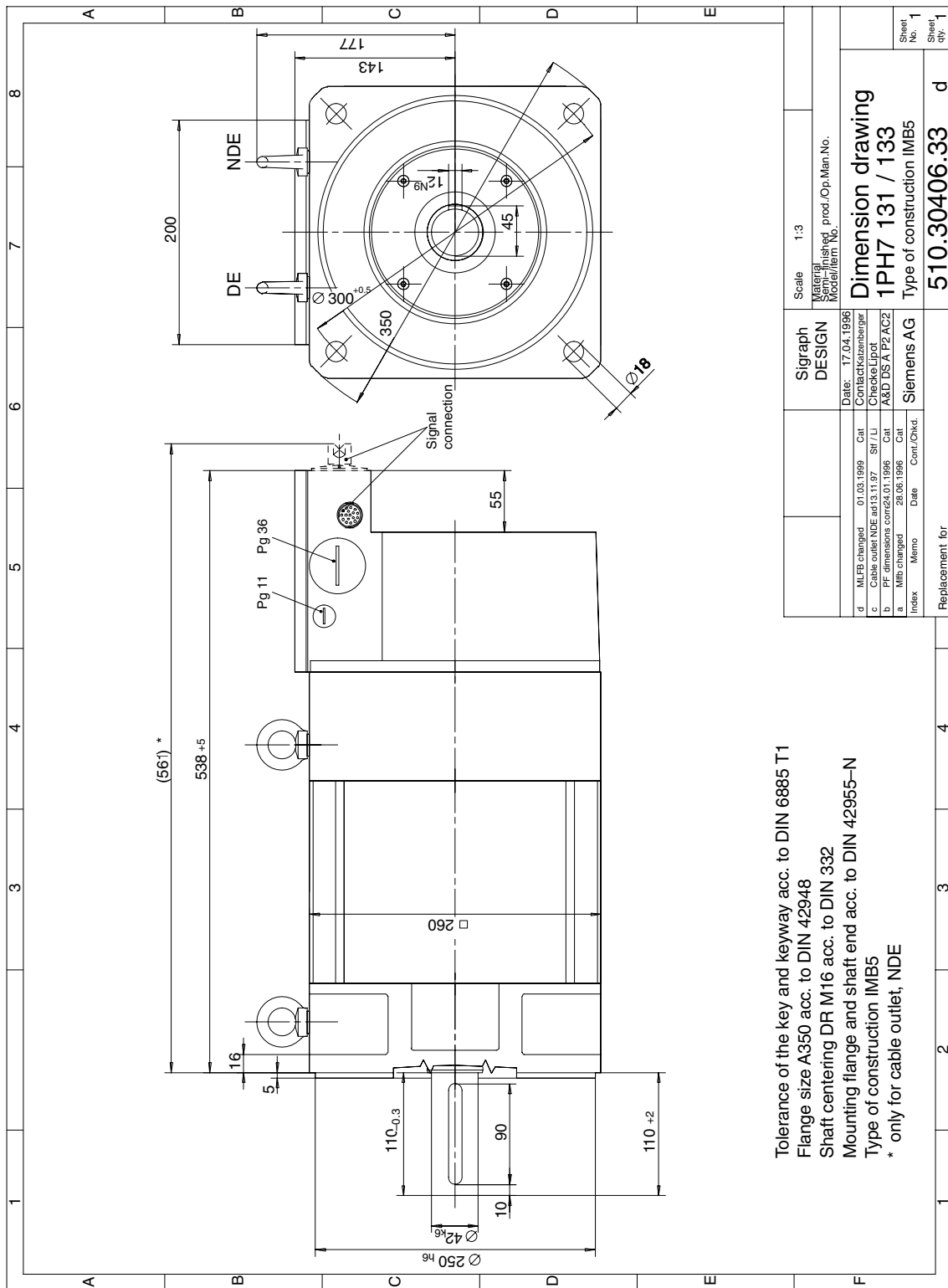

Fig. 4-15 1PH7131/1PH7133, type of construction IM B5

4.2 Type of construction IM B5 with separately-driven fan

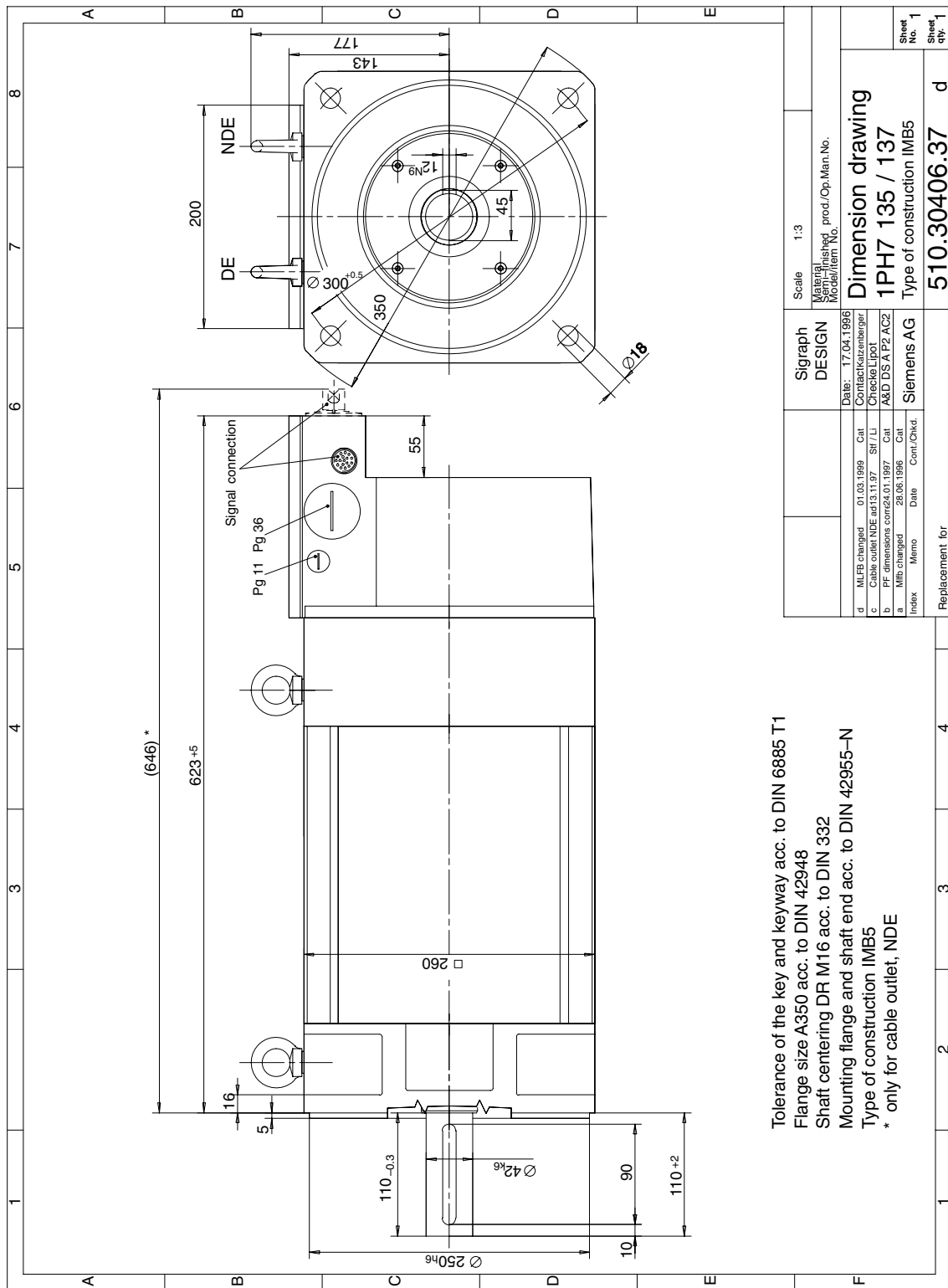

Fig. 4-16 1PH7135/1PH7137, type of construction IM B5

4.3 Type of construction IM B35 with separately-driven fan

4.3 Type of construction IM B35 with separately-driven fan

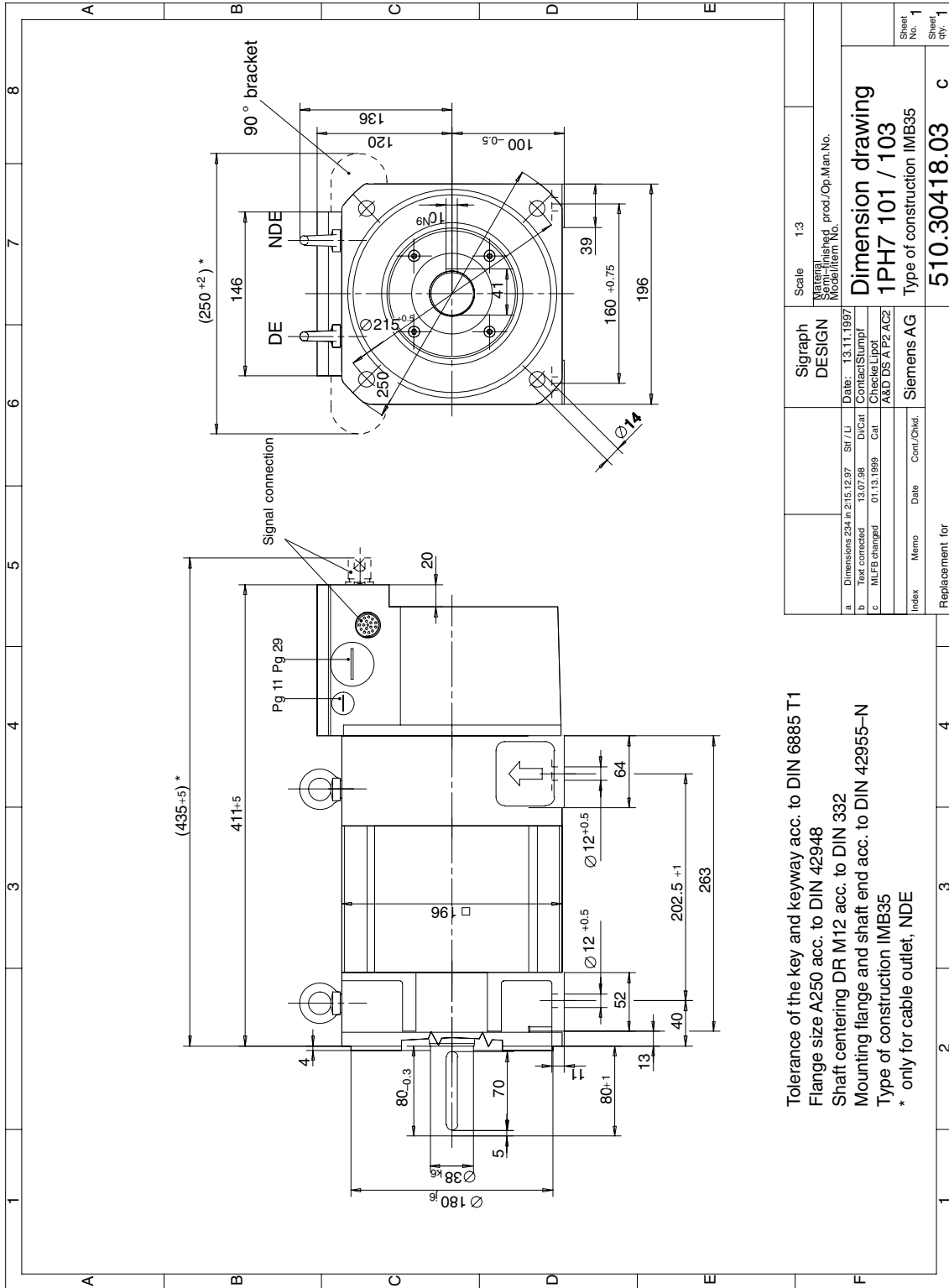

Fig. 4-17 1PH7101/1PH7103, type of construction IM B35

4.3 Type of construction IM B35 with separately-driven fan

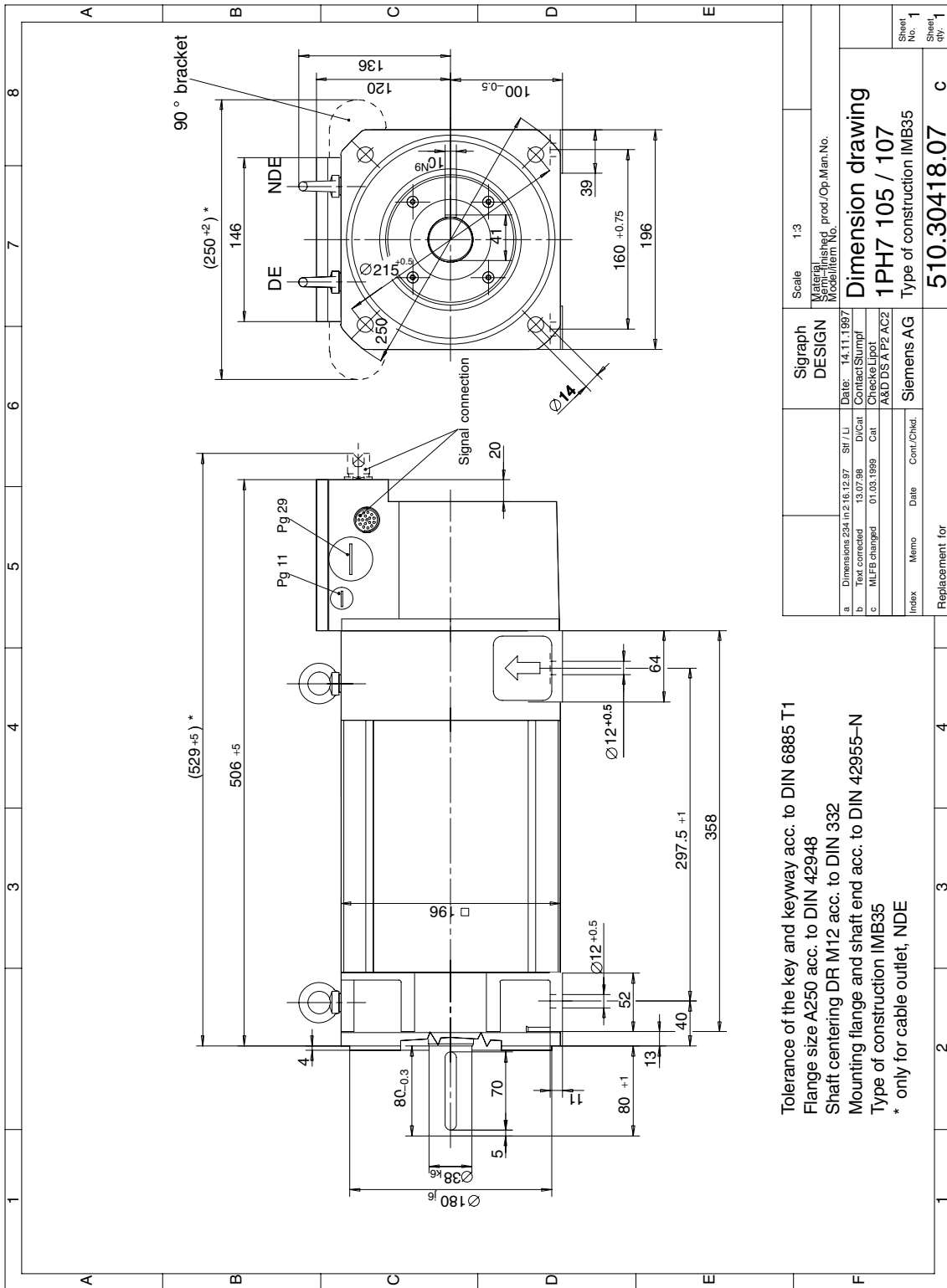

Fig. 4-18 1PH7105/1PH7107, type of construction IM B35

4.3 Type of construction IM B35 with separately-driven fan

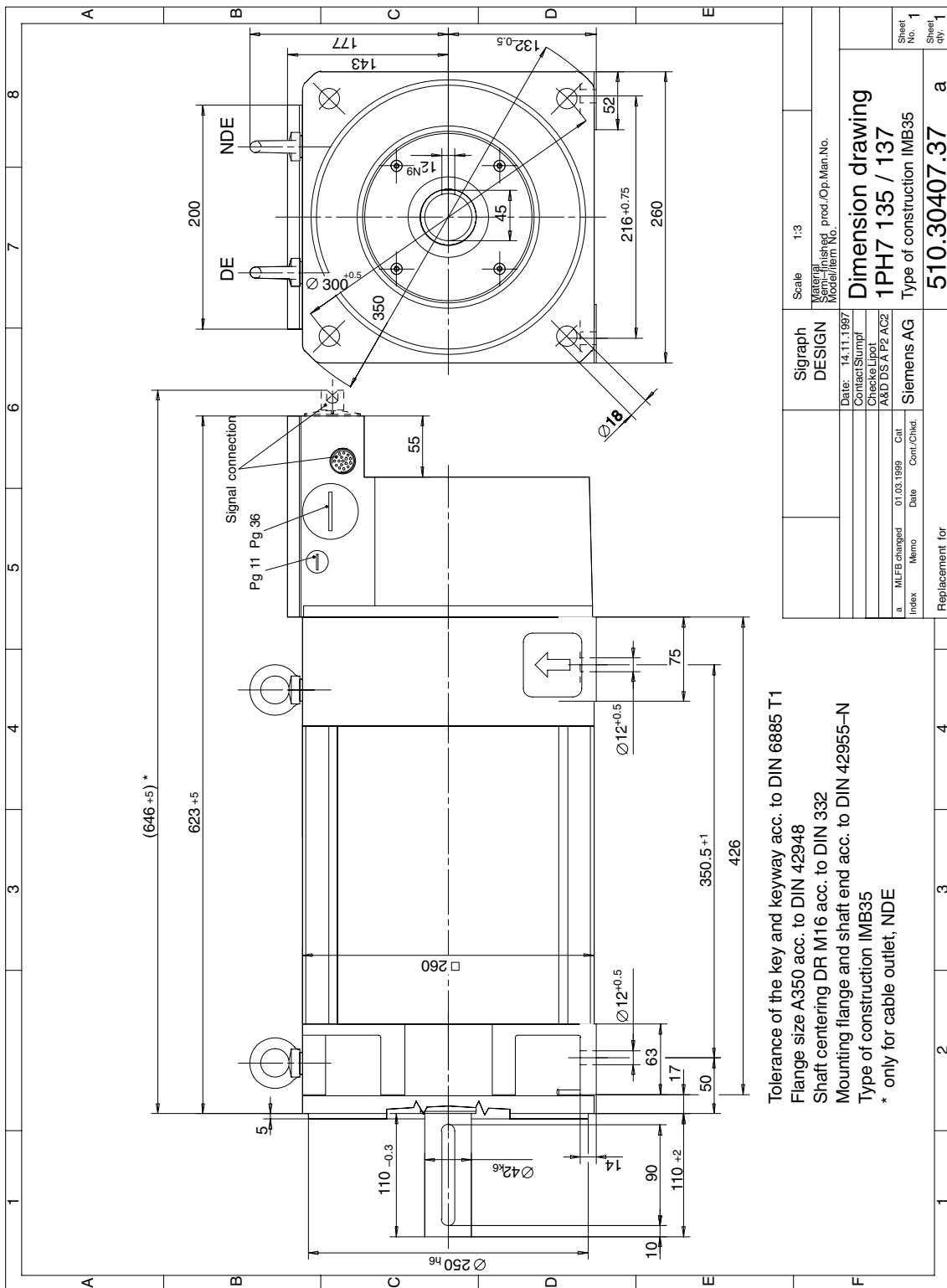

Fig. 4-20 1PH7135/1PH7137, type of construction IM B35

4.3 Type of construction IM B35 with separately-driven fan

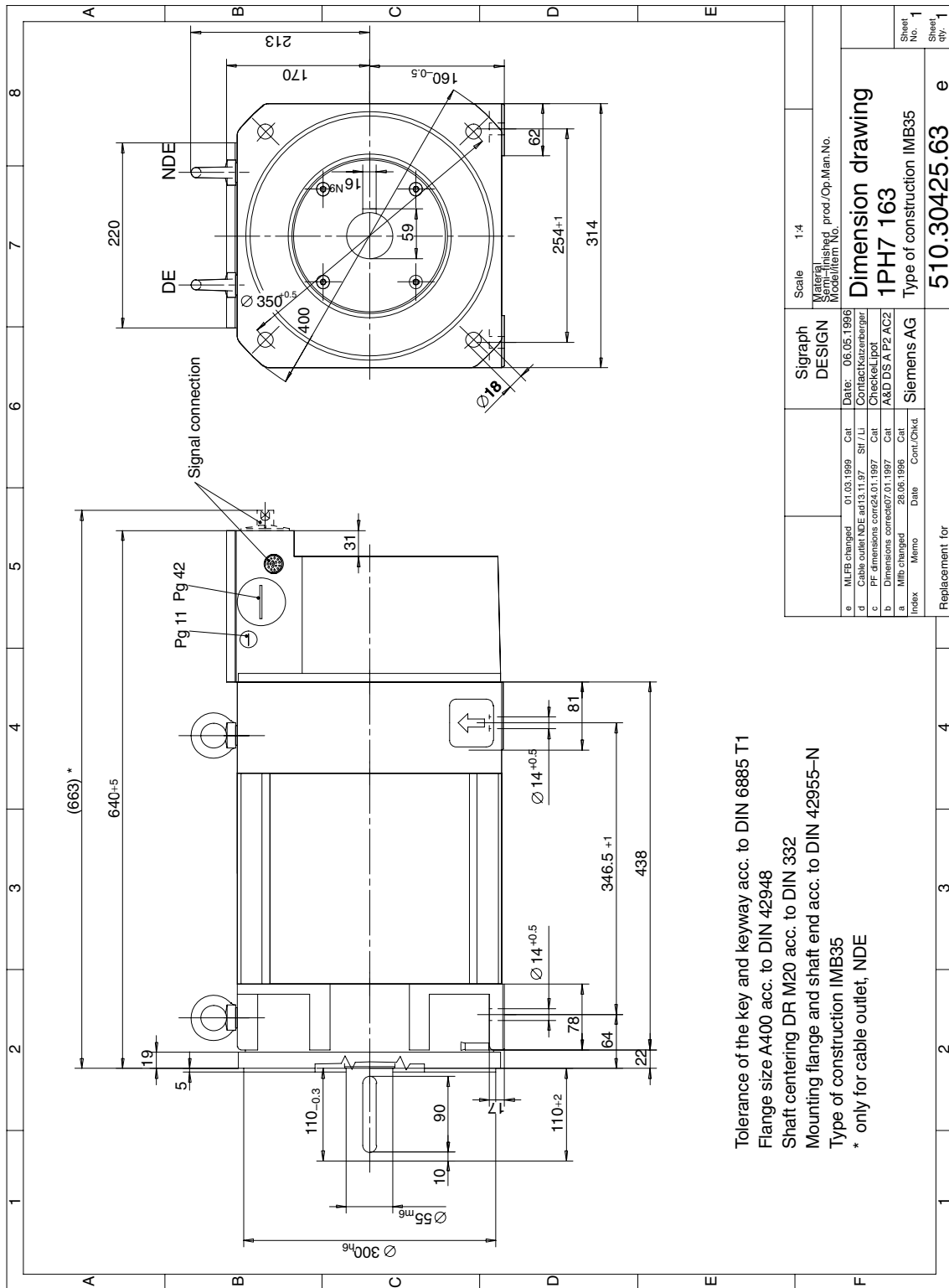

Fig. 4-21 1PH7163, type of construction IM B35

4.3 Type of construction IM B35 with separately-driven fan

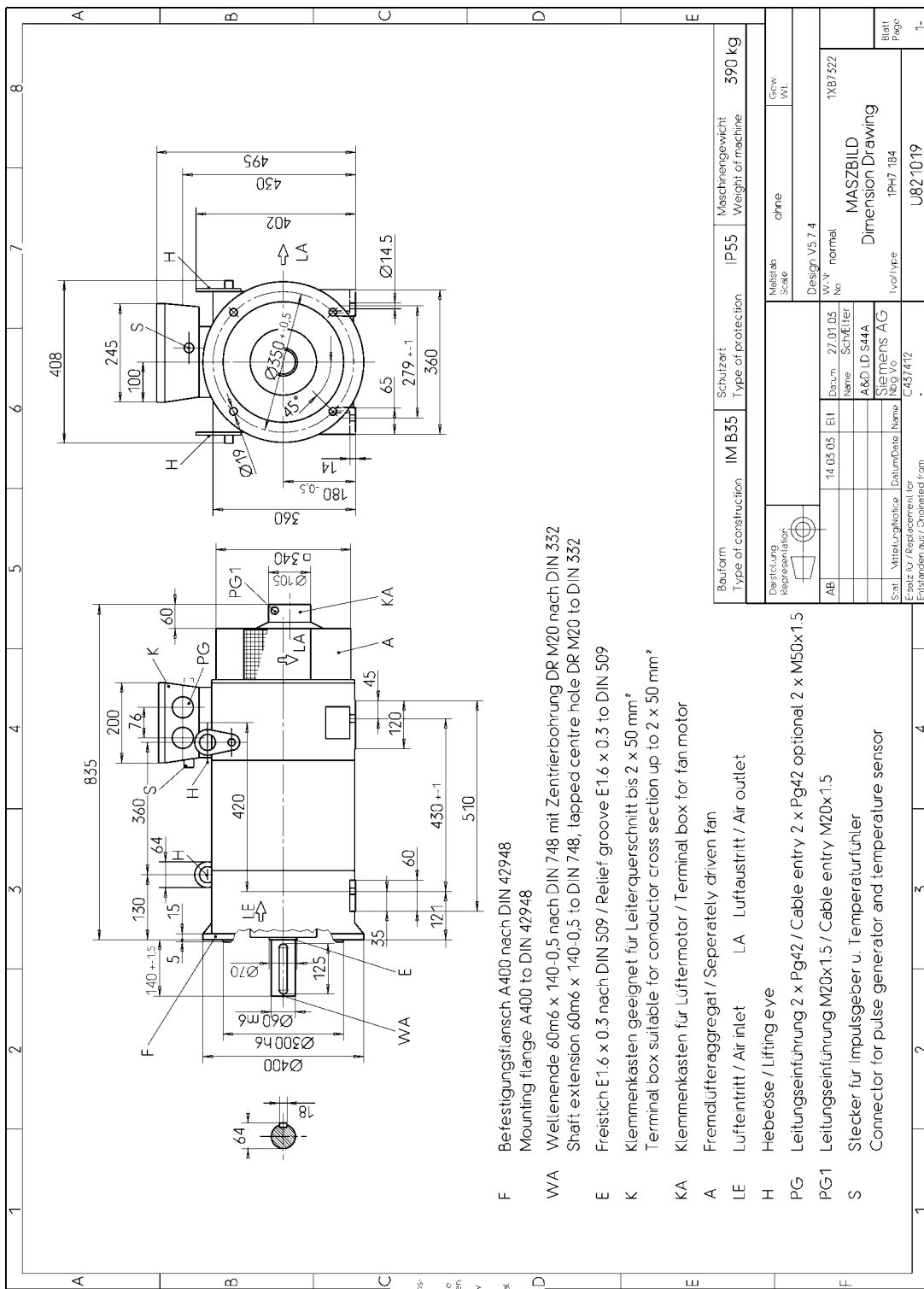

Fig. 4-23 1PH7184-□NT/D/E/F/L, type of construction IM B35, air flow direction DE → NDE, A400

4.3 Type of construction IM B35 with separately-driven fan

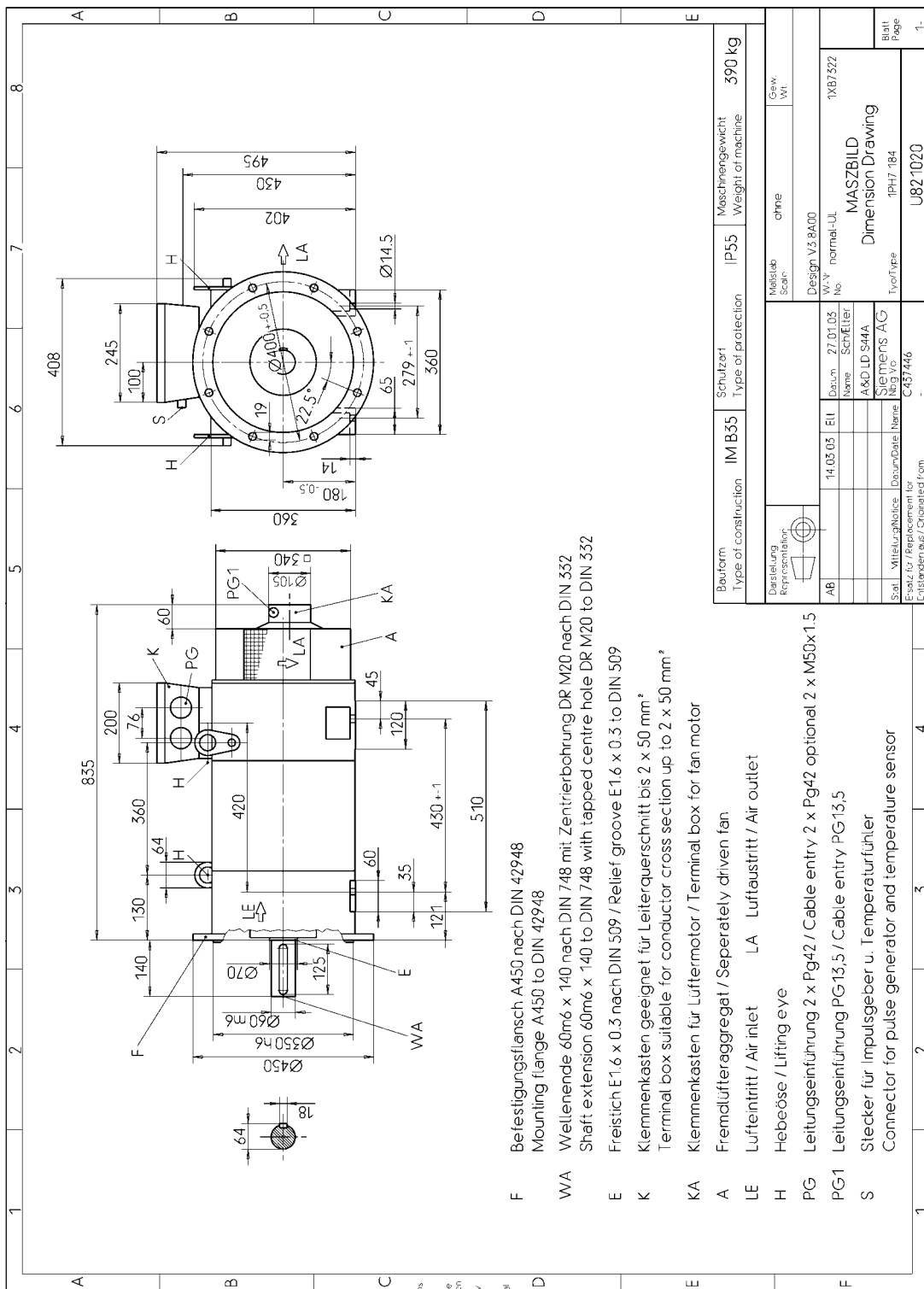

Fig. 4-25 1PH7184-□NT/D/E/F/L, type of construction IM B35, air flow direction DE → NDE, A450

4.3 Type of construction IM B35 with separately-driven fan

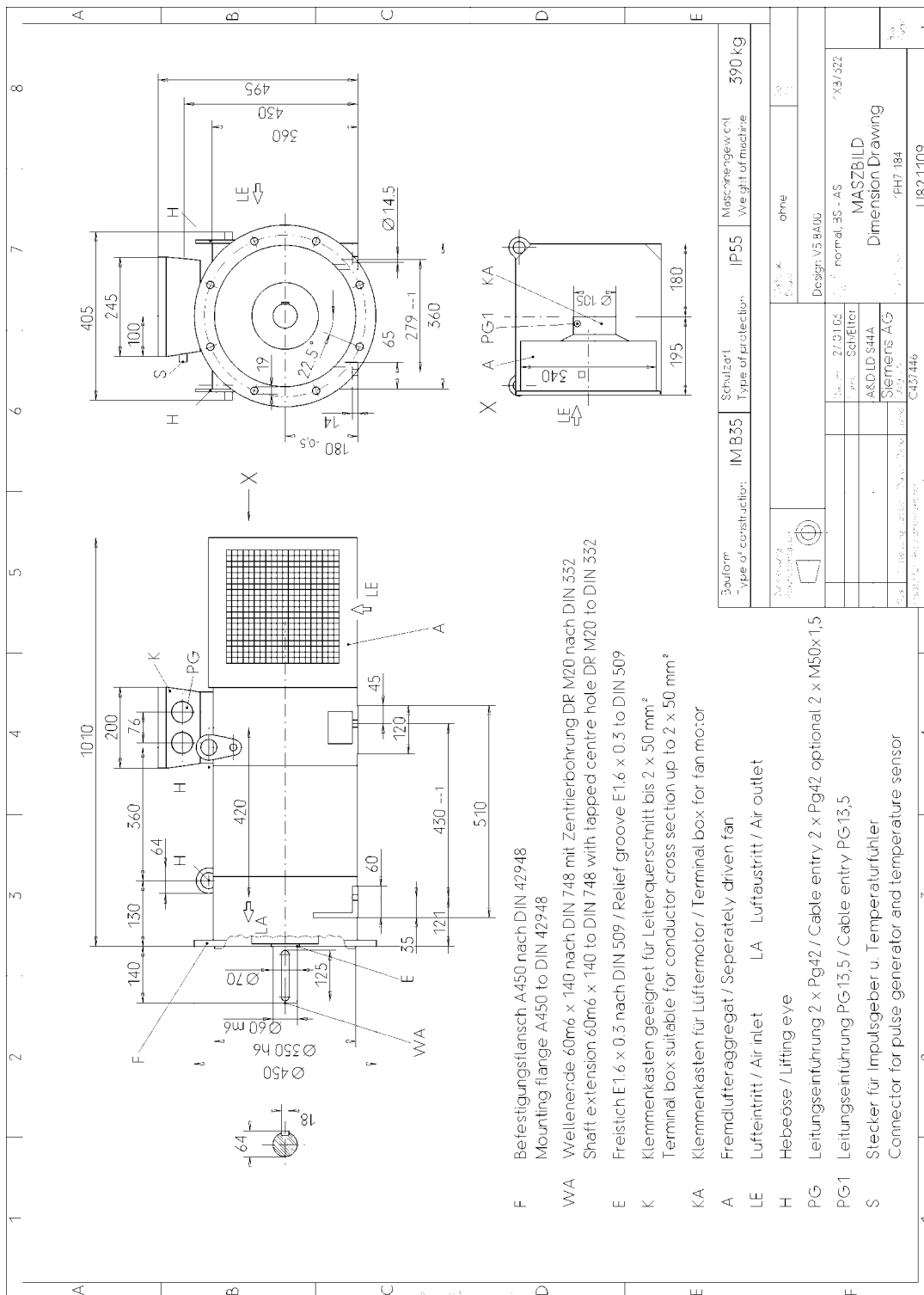

Fig. 4-26 1PH7184-□NT/D/E/F/L, type of construction IM B35, air flow direction NDE → DE, A450

4.3 Type of construction IM B35 with separately-driven fan

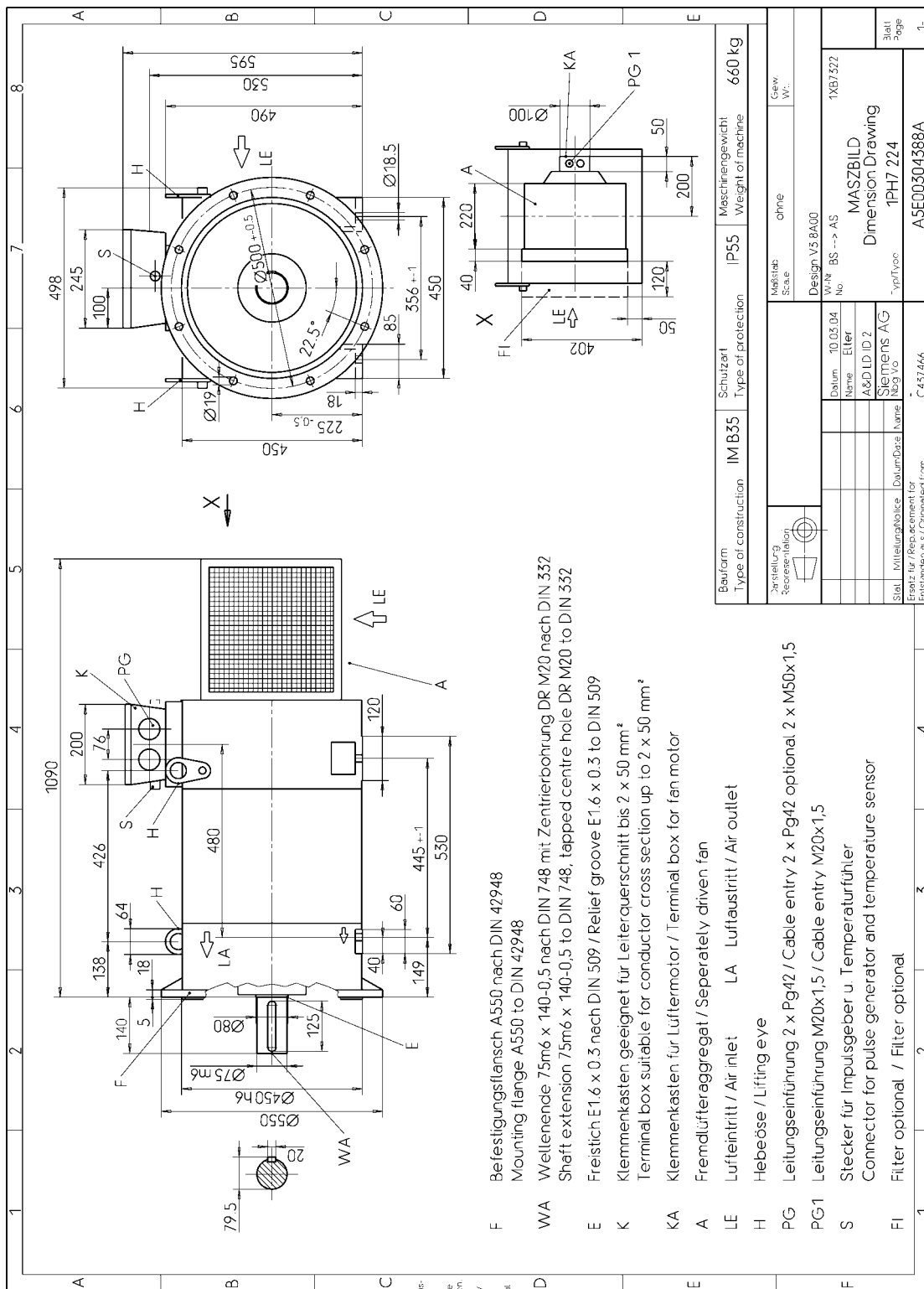

Fig. 4-30 1PH7224-□NC/D/F, type of construction IM B35, air flow direction NDE → DE

References

General Documentation

/BU/ Catalog NC 60
Automation Systems for Machine Tools
Order No.: E86060-K4460-A101-A9-7600

Electronic Documentation

/CD1/ DOC ON CD
The SINUMERIK System
(includes all SINUMERIK 840D/810D and SIMODRIVE 611D publications)
Order No.: 6FC5 298-7CA00-0BG0

Manufacturer/Service Documentation

/PJAS/ Planning Guide, AC Induction Motors
SIMODRIVE, MASTERDRIVES VC/MC
Contents: General Section, 1PH2, 1PH4, 1PH7 for SIMODRIVE, 1PH7
for MASTERDRIVES, 1PL6 for MASTERDRIVES VC/MC
Order No.: 6SN1197-0AC61-0BP0

/ASAL/ Planning Guide, AC Induction Motors
SIMODRIVE, MASTERDRIVES VC/MC
AC Induction Motors, General Section
Order No.: 6SN1197-0AC62-0BP0

/APH2/ Planning Guide, AC Induction Motors
SIMODRIVE
AC Induction Motors 1PH2
Order No.: 6SN1197-0AC63-0BP0

- /APH4/ Planning Guide, AC Induction Motors**
SIMODRIVE
AC Induction Motors 1PH4
Order No.: 6SN1197-0AC64-0BP0
- /APH7S/ Planning Guide, Induction Motors**
SIMODRIVE
Induction Servomotors, 1PH7 Main Spindle Drives
Order No.: 6SN1197-0AC65-0BP1
- /APH7M/ Planning Guide, AC Induction Motors**
MASTERDRIVES VC/MC
AC Induction Motors 1PH7
Order No.: 6SN1197-0AC66-0BP0
- /APL6/ Planning Guide, Induction Motors**
MASTERDRIVES VC/MC
AC Induction Motors 1PH6
Order No.: 6SN1197-0AC67-0BP0
- /PJM2/ Planning Guide, Synchronous Servomotors**
SIMODRIVE 611, MASTERDRIVES MC
Contents: General Section, 1FT5, 1FT6, 1FK6, 1FK7
Order No.: 6SN1197-0AC20-0BP0
- /PJAL/ Planning Guide, Synchronous Servomotors**
SIMODRIVE 611, MASTERDRIVES MC
Synchronous Servomotors, General Section
Order No.: 6SN1197-0AD07-0BP0
- /PFK7/ Planning Guide, Synchronous Servomotors**
SIMODRIVE 611, MASTERDRIVES MC
Synchronous Servomotors 1FK7
Order No.: 6SN1197-0AD06-0BP0
- /PFK6/ Planning Guide, Synchronous Servomotors**
SIMODRIVE 611, MASTERDRIVES MC
Synchronous Servomotors 1FK6
Order No.: 6SN1197-0AD05-0BP0

- /PFT5/ Planning Guide, Synchronous Servomotors**
SIMODRIVE
Synchronous Servomotors 1FT5
Order No.: 6SN1197-0AD01-0BP0
- /PFT6/ Planning Guide, Synchronous Servomotors**
SIMODRIVE 611, MASTERDRIVES MC
Synchronous Servomotors 1FT6
Order No.: 6SN1197-0AD02-0BP0
- /PPM/ Planning Guide, Hollow Shaft Motors**
SIMODRIVE
Hollow Shaft Motors for 1PM6 and 1PM4
Main Spindle Drives
Order No.: 6SN1197-0AD03-0BP0
- /PJFE/ Planning Guide, Synchronous Built-in Motors**
SIMODRIVE
Three-Phase AC Motors for Main Spindle Drives
1FE1 Built-in Synchronous Motors
Order No.: 6SN1197-0AC00-0BP1
- /PMS/ Planning Guide, Motor Spindle**
SIMODRIVE
ECO Motor Spindle 2SP1
Order No.: 6SN1197-0AD04-0BP1
- /PKTM/ Planning Guide, Complete Torque Motors**
SIMODRIVE
1FW3 Complete Torque Motors
Order No.: 6SN1197-0AC70-0BP1
- /PJTM/ Planning Guide, Integrated Torque Motors**
SIMODRIVE
1FW6 Integrated Torque Motors
Order No.: 6SN1197-0AD00-0BP2

/PJLM/ Planning Guide, Linear Motors
SIMODRIVE
1FN1 and 1FN3 Linear Motors
Order No.: 6SN1197-0AB70-0BP3

/PJU/ Planning Guide, Inverters
SIMODRIVE 611
Inverters
Order No.: 6SN1197-0AA00-0BP5

/EMV/ Planning Guide, EMC Installation Guideline
SINUMERIK, SIROTEC, SIMODRIVE
Order No.: 6FC5297-0AD30-0BP1

Operating Instructions

Operating Instructions 1PH7, SH 100 to SH 160

03.2004 Edition,

Order No.: 610. 43.429.21c

Operating Instructions 1PH718□

Order No.: German A5E00215737A

Order No.: English A5E00215729A

Order No.: Spanish A5E00215745A

Order No.: French A5E00215713A

Order No.: Italian A5E00215741A

Order No.: Swedish A5E00215747A

Operating Instructions 1PH722□

Order No.: German A5E00264361A

Order No.: English A5E00264369A

Order No.: Spanish A5E00264372A

Order No.: French A5E00264534A

Order No.: Italian A5E00264543A

Order No.: Swedish A5E00264554A



Index

A

Applications, 1PH7/1-13
Axial force diagrams, 1PH7/2-98

B

Bearing change intervals, 1PH7/1-28
Bearing version, 1PH7/1-28

C

Cantilever force diagrams, 1PH7/2-98
Commissioning software, vi
Connecting-up information, 1PH7/1-24
Connecting-up three-phase motors, 1PH7/1-23
Continuous speed, 1PH7/1-30
Cooling, 1PH7/1-21
Cooling-medium temperature, 1PH7/1-22

D

Danger and warning information, viii
Dimension Drawings, 1PH7/4-135
Documentation
 Danger and warning information, viii
 Design, v

E

Electrical connections, 1PH7/1-23
Encoders, 1PH7/3-119
ESDS instructions, x

F

Fan mounting, 1PH7/1-21
Features, 1PH7/1-13

G

Gearbox, 1PH7/3-121
 Electrical connection, 1PH7/3-126
 Features, 1PH7/3-122
 Flange dimensions, 1PH7/3-129
 Lubrication, 1PH7/3-128
 Prerequisites, 1PH7/3-121
 Technical. data, 1PH7/3-125
Gearbox dimensions, 1PH7/3-132
Gearbox stage selection, 1PH7/3-127

H

Hotline, vi

I

Increased max. speed, 1PH7/2-35
Incremental encoders, 1PH7/3-119

K

KTY 84, 1PH7/3-117

M

Maximum rotational speed, 1PH7/2-35
Moment of inertia, 1PH7/2-35
Motor Components, 1PH7/3-117
Motor rating plate, 1PH7/1-20
Mounting, 1PH7/1-32

O

Options, 1PH7/1-16

Order number

- Core types, 1PH7/1-18
- SH 100 to 160, 1PH7/1-17
- SH 180 to 225, 1PH7/1-19

P

- Power cable, 1PH7/1-23
 - Cross-sections, 1PH7/1-25
- Power de-rating, 1PH7/1-22
- Power-speed diagrams, 1PH7/2-38

R

- Rated current, 1PH7/2-35
- Rated speed, 1PH7/2-35
- Rating plate, 1PH7/1-20

S

- Selector gearbox, dimensions, 1PH7/3-133

Separately-driven fan

- Connecting, 1PH7/1-26
 - Recommended connection, 1PH7/1-27
- Speed-torque diagrams, 1PH7/2-38
- Standstill current, 1PH7/2-35
- Structure of the documentation, v
- Support, vi

T

- Technical Data, 1PH7/2-35
- Technical design, 1PH7/1-14
- Technical Support, vi
- Terminal box, 1PH7/1-26
- Thermal motor protection, 1PH7/3-117

V

- Vibration severity limit values, 1PH7/1-31

To
SIEMENS AG
A&D MC BMS
P. O. Box 3180
D-91050 Erlangen, Germany
 Tel.: +49 (0)180 / 5050-222 [Service Support]
 Fax: +49 (0)9131 / 98-2176 [Documentation]
 email: motioncontrol.docu@erlf.siemens.de

	Suggestions
	Corrections
	For Publication/Manual:
	Induction Motors 1PH7 Main Spindle Drives
	Manufacturer/Service Documentation
From	Planning Guide
Name _____	Order No.: 6SN1197-0AC65-0BP1 Edition: 05.2004
Company/Dept. _____	Should you come across any printing errors when reading this publication, please notify us on this sheet.
Address _____	Suggestions for improvement are also welcome.
Zip code: Town: _____	
Phone: / _____	
Fax: / _____	

Suggestions and/or corrections

Siemens AG

Automation & Drives

Motion Control Systems

P. O. Box 3180, D – 91050 Erlangen

Germany

www.siemens.com/motioncontrol

© Siemens AG, 2004
Subject to change without prior notice
Order No.: 6SN1197-0AC65-0BP1

Printed in Germany